



Implications for Future SE Practice, Education, Research: **SE Foundation Elements**

Discussion Inputs to *INCOSE Vision 2035* Theoretical Foundations Section

Acknowledgements

Early drafts of this material were assembled in 2019 from past writings by the author. Special thanks for the improvements that followed are owed by the author to:

- Sandy Friedenthal and Heinz Stoewer, for asking for this material, providing valued early feedback, and encouraging the overall effort;
- Tom McDermott, Chris Paredis, David Rousseau, Jon Wade, and Michael Watson, for thoughtful review of and valued feedback on the 2019 draft, and the subsequent team review workshop and discussion of IW2020.

The deep expertise and contributions of these colleagues to our systems community are gratefully acknowledged.

Abstract

- The traditional engineering disciplines are supported by companion physical sciences, each with a focal physical phenomenon. But Systems Engineering had a different kind of origin in the mid twentieth century. Instead of a scientific phenomenon, its focus was process and procedure for improved technical integration of the traditional engineering disciplines with each other and with stakeholder value. More recently, *INCOSE Vision 2025* has called for a strengthened scientific foundation for SE, even as SE also becomes more subject system model-based. A number of paths toward such a system science have been pursued or proposed. How might we judge the value of what has been identified or pursued so far, against the goals set by *Vision 2025*?
- Following millennia of slower progress, in only 300 years the physical sciences and engineering disciplines that they support have transformed the quality, nature, and possibilities of human life on Earth. That global demonstration of the practical impact of science and engineering provides us with a benchmark against which we may judge the practical value to SE of candidate foundational elements. We should demand no less in seeking science-based impact equivalence.
- This material summarizes three initial elements of proposed scientific foundations for systems, emphasizing their already established historical basis and success in other disciplines, and noting their practical impacts on future SE practice, education, and research, toward phenomena-based scientific, mathematical, and humanistic foundations for the discipline.

Agenda

- Background and Motivation
- The System Phenomenon
- The Value Selection Phenomenon
- The Model Trust by Groups Phenomenon
- Implications for Practitioners, Educators, Researchers

- References
- Attachment I: More about the above phenomena

INCOSE *SE Vision 2025*: Called for stronger SE foundations



Page 40

Page 41

“From:

Systems engineering practice is only weakly connected to the underlying theoretical foundation, and educational programs focus on practice with little emphasis on underlying theory.”

“To:

The theoretical foundation of systems engineering encompasses not only mathematics, physical sciences, and systems science, but also human and social sciences. This foundational theory is taught as a normal part of systems engineering curricula, and it directly supports systems engineering methods and standards. Understanding the foundation enables the systems engineer to evaluate and select from an expanded and robust toolkit, the right tool for the job.”

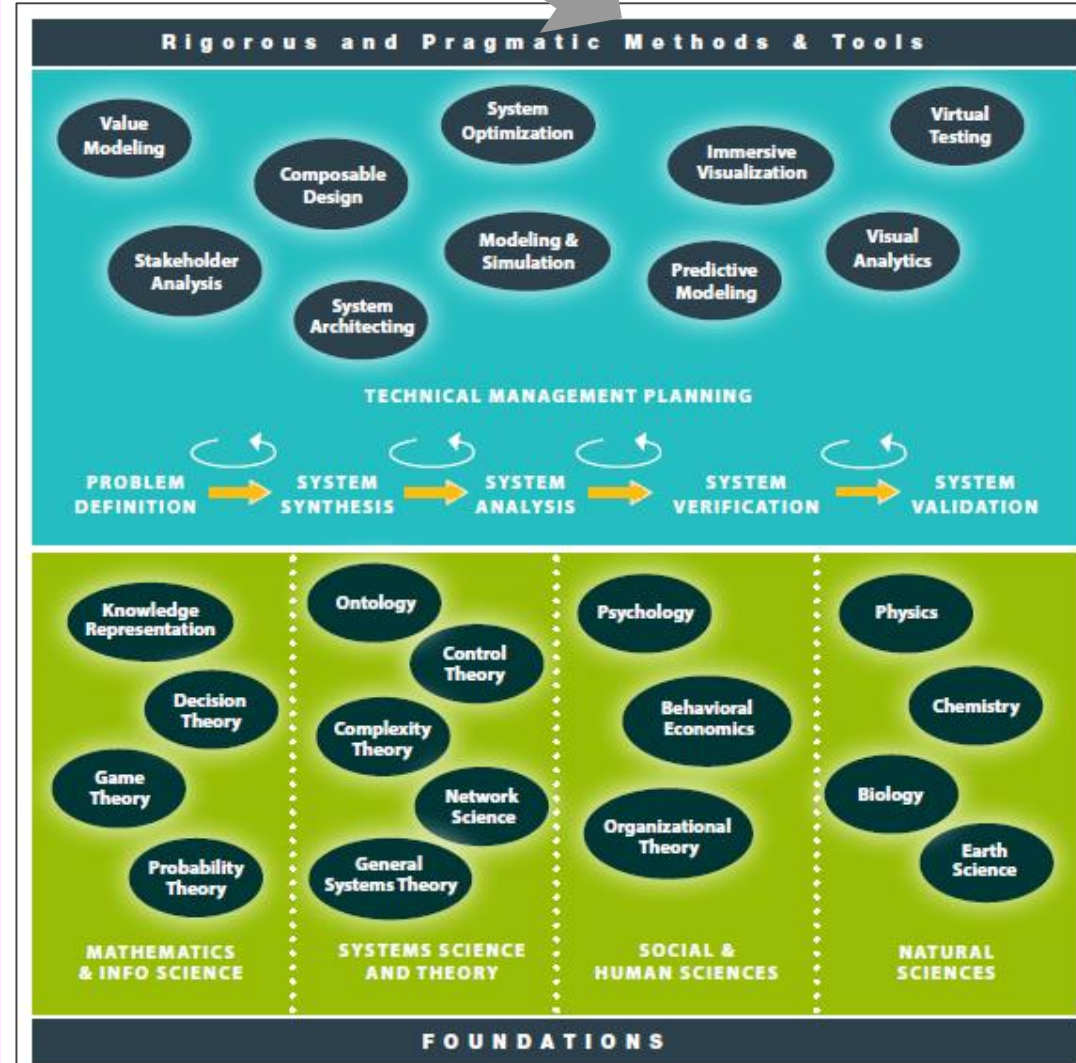

Background and Motivation



For good reason, math, science, and humanistic foundations for Systems Engineering were called for in *INCOSE Vision 2025*:

- The success of the phenomena-specific engineering disciplines is founded on their related physical sciences and mathematics.
- SE practices and methods across diverse application domains should likewise be understood and selected based on such a foundation.
- Engineering education of both systems engineers and the other engineering disciplines should be based on a shared understanding of their common underlying technical foundation.
- Research and advancement in the practice of SE should take advantage of its underlying and expanding technical foundation.

Background and Motivation



- In the following, we will assert that much of that foundation is closer than realized, not always requiring discovery “from scratch”:
 - Already identified in well-established foundations of STEM and other disciplines, discovered and highly successful during three centuries of the transformation of human life
 - Awaiting wider awareness and exploitation by the systems community, providing a powerful starting point for what will follow.
 - Both quantitative and qualitative; richly endowed with humanistic aspects.
- We will summarize three phenomenon-based elements of that foundation, providing starting points already known.
- Finally, we will point out implications of these elements for SE Practitioners, Educators, and Researchers.

Consensus: Challenge and Opportunity



The challenge of Theoretical Foundations called for in *Vision 2025* has yet to be fulfilled to the degree called for:

- Differing views about this across the systems community are a challenge, but . . .
- How technical communities come to trust a common model is in fact one of the three natural phenomena reviewed here.
- Remember the threshold level called for in the Abstract, in terms of impact on a world of systems.
- How do we identify and exploit a theoretical foundation that can greatly accelerate our Systems Engineering progress on a par with other revolutions?

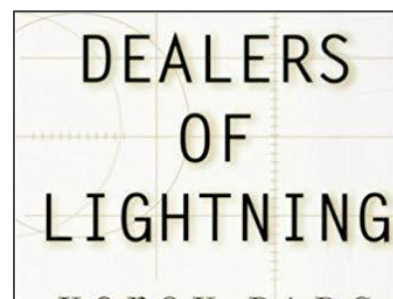
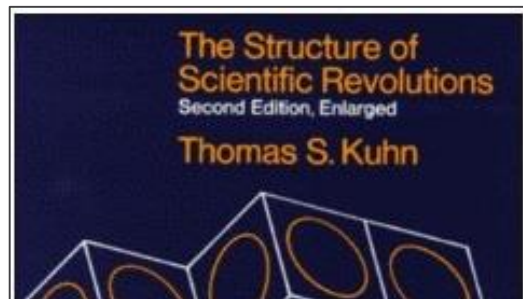

Why “Phenomena” are emphasized here

Before we assert principles, laws, or other theoretical foundation elements, there first ought to be something that those statements are “*about*”:

- Phenomena are occurrences observed in the world, and are the focal basis of the historical scientific and engineering disciplines—the “hard” sciences and otherwise.
- The choices of which phenomena to study has been a critical aspect of the history of progress, and often what divides the scope of different disciplines from each other.

Example phenomena:

Lightning strikes trees.	People learn.	Customers have favorite products.
Sun, Moon, stars cross the sky.	Wood burns.	Teams have different performance.
Birds migrate.	People argue.	Atoms don't run down.
Magnets attract and repel.	Ice melts.	Blown pipes resonate.
Children resemble parents.	Animals sleep.	Water evaporates.
Designers overlook requirements.	Plants grow.	Geese fly in Vee formations.

Following are *three phenomena of interest here* . . . 9

1. The System Phenomenon

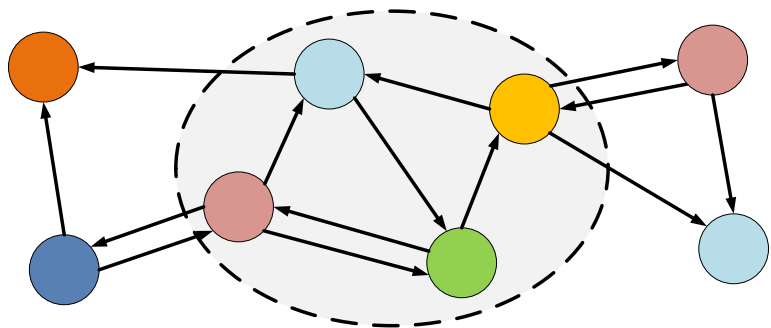

2. The Value Selection Phenomenon

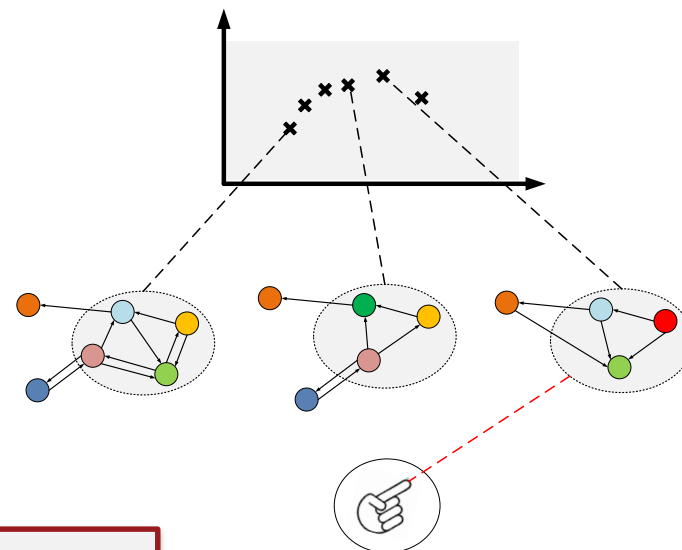

Three Foundational Systems Phenomena

3. The Model Trust by Groups Phenomenon

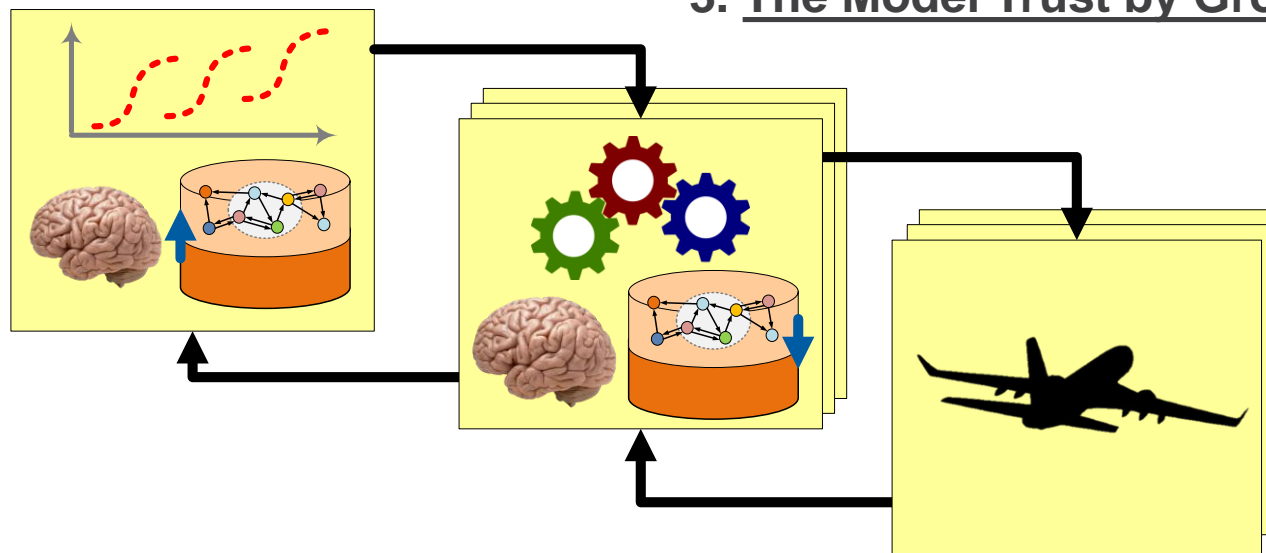

Three Real Phenomena That Are Key to SE Foundations

-  **1. The System Phenomenon:** Each of the traditional physical sciences is based on a specific physical phenomenon (mechanical, electrical, chemical, etc.) and related mathematical formulation of physical laws and first principles. What is the equivalent “hard science” phenomenon for systems, where is its mathematics, and what are the impacts on future SE practice? Are there also “soft” aspects?
- 2. The Value Selection Phenomenon:** Engineers know that value is essential to their practice, but its “soft” or subjective nature seems challenging to connect to hard science and engineering phenomena. What is the bridge effectively connecting these, where is the related mathematics, and what are the impacts on future SE practice?
- 3. The Model Trust by Groups Phenomenon:** The physical sciences accelerated progress in the last three centuries, as they demonstrated means for not just the discovery and representation of Nature’s patterns, but also the managed awarding of graduated shared trust in them. What is the scientific basis of such group learning, how is it related to machine learning, and how does it impact the future practice of SE?

1. Disciplines and their Phenomena

The traditional engineering disciplines have their technical bases and quantitative foundations in the hard sciences' descriptions of phenomena:

Engineering Discipline	Phenomena	Scientific Basis	Representative Scientific Laws
Mechanical Engineering	Mechanical Phenomena	Physics, Mechanics, Mathematics	Newton's Laws
Chemical Engineering	Chemical Phenomena	Chemistry, Mathematics. . . .	Periodic Table
Electrical Engineering	Electromagnetic Phenomena	Electromagnetic Theory	Maxwell's Equations
Civil Engineering	Structural Phenomena	Materials Science, . . .	Hooke's Law, etc.
Semiconductor Eng'g	Semiconductor Phenomena	Solid State Physics, . . .	Quantum Mechanics

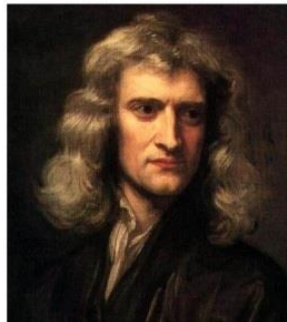

Newton



Mendeleev

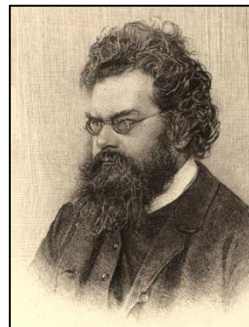

Boltzmann

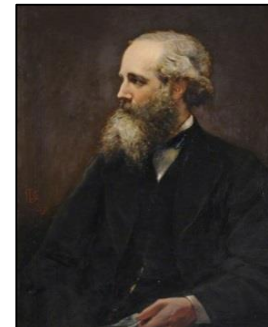

Maxwell

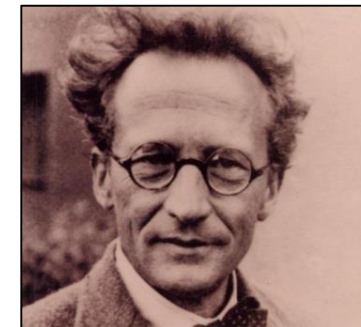

Schrödinger

1. Disciplines and their Phenomenon

Other “softer” technical disciplines are argued (by some) as less “hard science” oriented, but their phenomena are no less important to humanity:

Discipline	Phenomena
Human Psychoanalysis	Psychopathology, Psychotherapy
Medical Science	Human Health, Disease, Therapy
Behavioral Economics	Human Choice Behavior
Macro Economics	Consumption, Monetary Phenomena, Economic Stability
Genetic Epistemology	Learning, Childhood Development
General Systems Theory	Systemic Phenomena

Freud

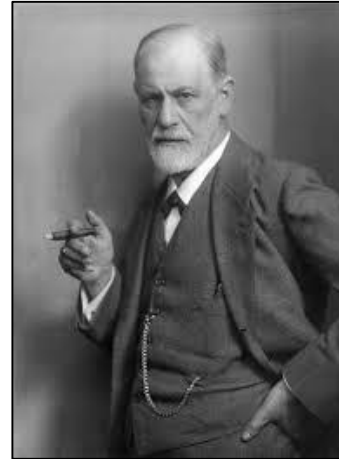

Piaget



Khaneman

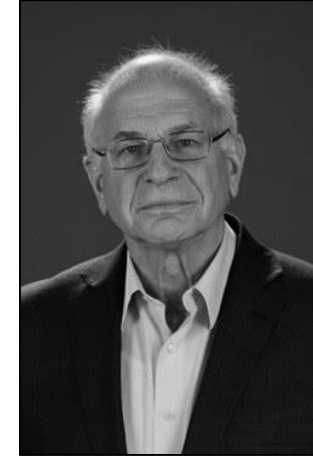

Bertalanffy

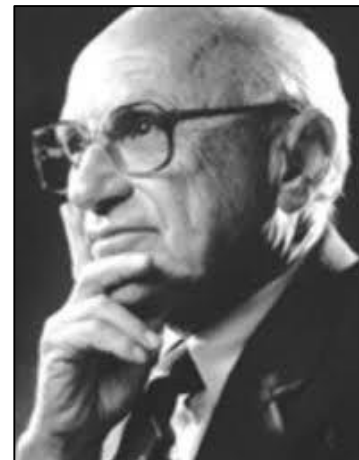

Friedman



Mayo Brothers

Traditional Perspective on SE—as we know it today

- Specialists in individual engineering disciplines (ME, EE, CE, ChE—without them, we would be living as in 1500) sometimes argue that their fields are based on:
 - “real physical phenomena”,
 - physical laws based in the “hard sciences”, and first principles, . . .
- . . . while sometimes claiming that Systems Engineering lacks the equivalent phenomena-based theoretical foundation.

$$\nabla \cdot \mathbf{D} = \rho$$

$$\nabla \cdot \mathbf{B} = 0$$

$$\nabla \times \mathbf{E} = -\frac{\partial \mathbf{B}}{\partial t}$$

$$\nabla \times \mathbf{H} = \mathbf{J} + \frac{\partial \mathbf{D}}{\partial t}$$

$$\frac{N_b}{N_a} = \left(\frac{g_b}{g_a}\right) e^{-(E_b - E_a)/kT}$$

$$H(t)|\psi(t)\rangle = i\hbar \frac{\partial}{\partial t} |\psi(t)\rangle$$

- Instead, Systems Engineering is sometimes viewed as:
 - Emphasizing process and procedure in its literature
 - Critical thinking and good writing skills
 - Organizing and accounting for information
 - Integrating the work of the other engineering disciplines and stakeholder needs
- But not based on an underlying “hard science” like other engineering disciplines

A standard periodic table of elements, color-coded by groups. The title "Periodic Table of the Elements" is centered at the top. The table includes element symbols, names, and atomic numbers. It is organized into seven rows and 18 columns, with the lanthanide and actinide series shown as separate rows at the bottom.

Formalizing System Terms and Representations

- Definition: *In the perspective described here**, by “System” we mean a collection of interacting system components:

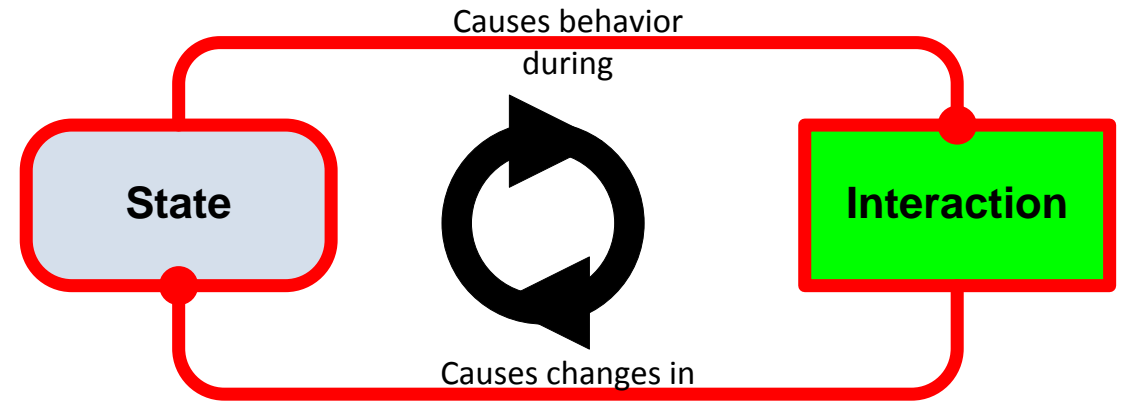
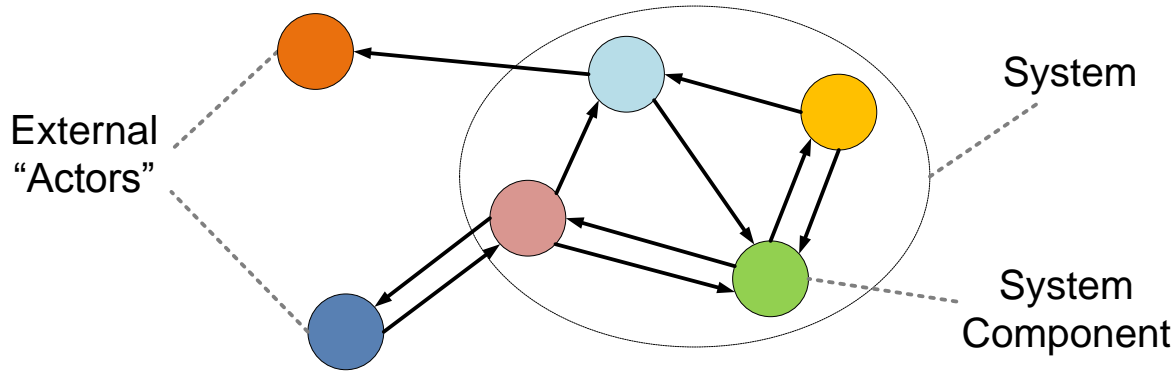

- By “interacting” we mean the exchange of energy, force, material, or information (all of these are “input-outputs”) between system components, . . .
- . . . through which one component impacts the state of another component.
- By “state” we mean a property of a component that impacts its input-output behavior during interactions. (Note the circular cause-effect definition chain here.)
- So, a component’s “behavior model” describes input-output-state relationships during interaction—*there is no “naked behavior” in the absence of interaction.*
- The behavior of a system involves emergent *states of the system as a whole*, exhibited in its behavior during its own external interactions, resulting in observable holistic aspects.

(* Other world view definitions of “System” are acknowledged; there are reasons for our minimalist choice of definitions.)

The System Phenomenon

- Phenomena of the hard sciences in all instances occur in the presence of special cases of the (generalized) “System Phenomenon”:
 - The System Phenomenon: System behavior emerges from the interaction of behaviors (phenomena themselves) of system components a level of decomposition lower.
- Each emergent phenomenon is visible through the interaction-based behavior of the larger system with its own external environment:

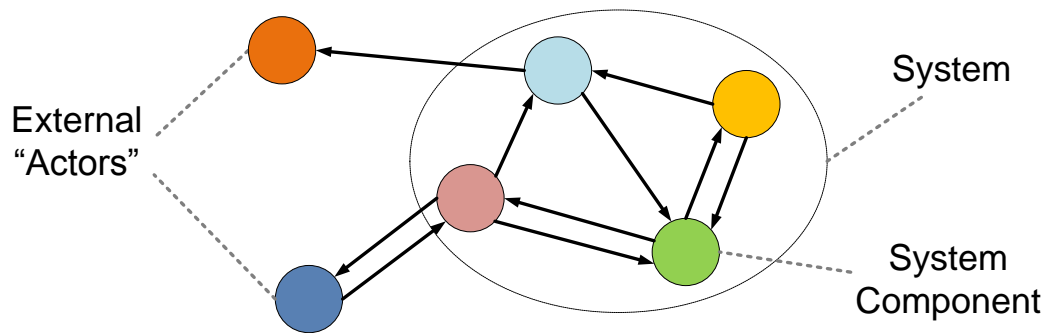

The combinatorial nature of emergent phenomena can be unpredictably diverse, as well as unlike the component behaviors. For why this is so, see Att 1.

- The resulting “patterns” of recurring larger-scale behavior become the basis for recognition, mathematical laws of motion or other hard science, heuristics, rules of thumb, intuition, prediction, or other exploitation of those regularities.
- Phenomena in the “softer” domains in all instances likewise occur in the presence of cases of the above System Phenomenon, even though the domain-specific phenomena, input-outputs, states, and behaviors are different.



Patterns: The heart of scientific laws, rules of thumb, intuition

- All “patterns” are recurrences, having both fixed and variable (configurable) aspects.
- The heart of physical science’s life-changing 300 year success in prediction and explanation lies in recognition, representation, exploitation of recurring patterns.
- Also at the heart of deep human intuition, expertise, and heuristics (see Maier and Rechtin, Appendix A).

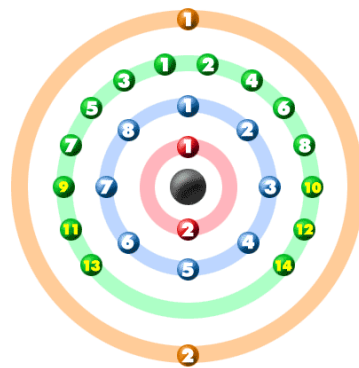
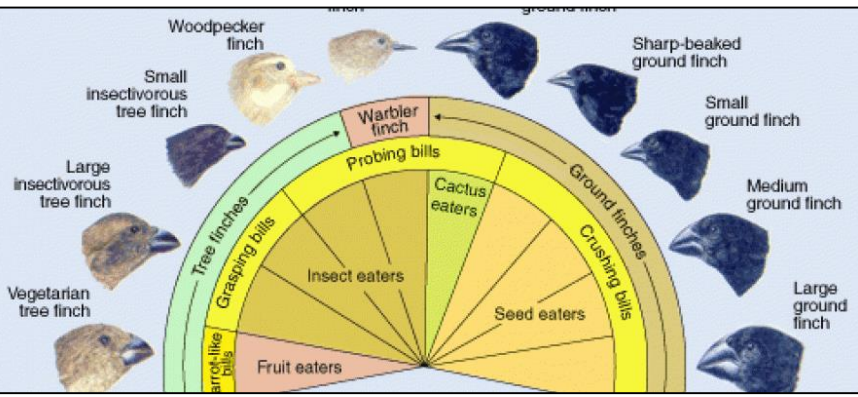
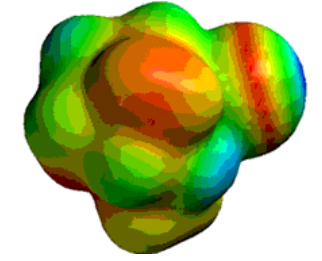
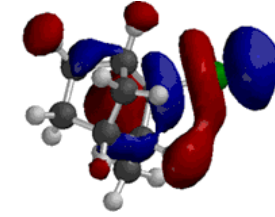
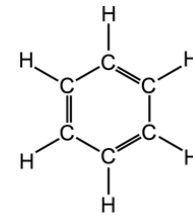

26
Fe
55.85

2
8
14
2

Periodic Table of the Elements

1	2											18	19	20			
H	He											Ar	K	Ca			
Li	Be	B	C	N	O	F	Ne	Na	Mg	Al	Si	P	S	Cl	Ar		
K	Ca	Sc	Ti	V	Cr	Mn	Fe	Co	Ni	Cu	Zn	Ga	Ge	As	Se	Br	Kr
Rb	Sr	Y	Zr	Nb	Mo	Tc	Ru	Rh	Pd	Ag	Cd	In	Sn	Sb	Te	I	Xe
Cs	Ba	Hf	Ta	W	Re	Os	Ir	Pt	Au	Hg	Tl	Pb	Bi	Po	At	Rn	
Fr	Ra	Rf	Db	Sg	Bh	Hs	Mt	Ds	Rg	Cn	Uut	Fll	Uup	Lv	Uus	Uuo	
Lanthanide Series		La	Ce	Pr	Nd	Pm	Sm	Eu	Gd	Tb	Dy	Ho	Er	Tm	Yb	Lu	
Actinide Series		Ac	Th	Pa	U	Np	Pu	Am	Cm	Bk	Cf	Es	Fm	Md	No	Lr	
		Alkaline Earth	Transition Metals	S-block	d-block	f-block	p-block										

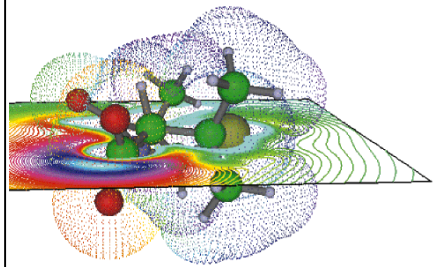

STEM Triumphed for Large Subsets of the System Phenomenon

Engineering Discipline	Phenomena Special Case	Scientific Basis	Scientific Laws
Mechanical Engineering	Mechanical Phenomena	Physics, Mechanics, Mathematics	Newton's Laws
Chemical Engineering	Chemical Phenomena	Chemistry, Mathematics. . . .	Periodic Table
Electrical Engineering	Electromagnetic Phenomena	Electromagnetic Theory	Maxwell's Equations
Civil Engineering	Structural Phenomena	Materials Science, . . .	Hooke's Law, etc.
Semiconductor Eng'g	Semiconductor Phenomena	Solid State Physics, . . .	Quantum Mechanics

- For each such emergent phenomenon¹, the emergent interaction-based behavior of the larger system is a stationary state space trajectory of the action integral:

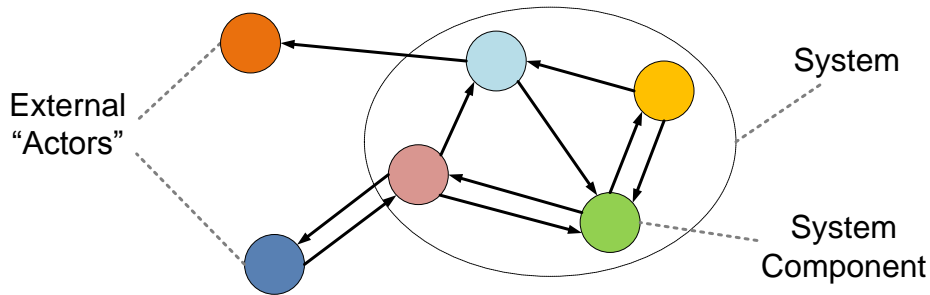

$$S = \int_{t_1}^{t_2} L(x, \dot{x}, t) dt ; \quad \delta[S] = 0$$

← (Hamilton's Principle¹)

- Reduced to simplest forms, the resulting equations of motion (or if not solvable, simulated/observed paths) provide “physical laws” subject to scientific verification—an amazing foundation supporting all above phenomena.

(1) When stated with rigor, special cases for non-holonomic constraints, irreversible dynamics, discrete systems, data systems, etc., led to alternatives to the variational Hamilton's Principle—but the interaction-based structure of the System Phenomenon remained, and the underlying related Action and Symmetry principles became the basis of modern theoretical physics. See Att 1. 18

The above generalization is long known:
Max Planck on Hamilton's Principle
(aka Principle of Least Action)



*“It [science] has as its highest principle and most coveted aim the solution of the problem to condense all natural phenomena which have been observed and are still to be observed into one simple principle, that allows the computation of past and more especially of future processes from present ones. ...Amid the more or less general laws which mark the achievements of physical science during the course of the last centuries, **the principle of least action** is perhaps that which, as regards form and content, may claim to come nearest to that ideal final aim of theoretical research.”*

Max Planck, as quoted by Morris Kline, *Mathematics and the Physical World* (1959) Ch. 25: From Calculus to Cosmic Planning, pp. 441-442

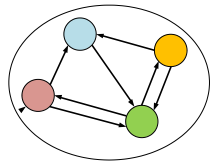

The System Phenomenon: Conclusion

- Each of the so-called “fundamental” phenomena-based laws’ mathematical expression (Newton, Maxwell, Schrodinger, et al) is derivable from the above formulation—as shown in many discipline-specific textbooks.
- So, instead of Systems Engineering lacking the kind of theoretical foundation the “hard sciences” bring to other engineering disciplines, . . .
 - It turns out that all those other engineering disciplines’ foundations are themselves dependent upon the System Phenomenon and Hamilton’s Principle mathematical expression of the inductive pattern from Level N to Level N+1 (many others followed with generalizations and extensions to other cases—see Att. 1).
 - **SO**, the underlying math and science of systems provides the theoretical basis already used by all the hard sciences and their respective engineering disciplines.
 - It is not Systems Engineering that lacks its own foundation—instead, it has been providing the so-called foundations claimed by each of the other disciplines!
 - This opens a new perspective on how Systems Engineering and Systems Science can relate to the other, better-known disciplines, as well as future domains . . .

- The System Phenomenon and its supporting mathematics (Hamilton et al) provide the inductive ladder, explaining (*) theory of each new level in terms of the previous level.
- As higher-level system patterns are discovered, represented, validated, taught, and practiced, they become “emergent domain disciplinary frameworks”.
- This is evident in the history of scientific and engineering domains and disciplines, and newer emerging ones.

- | | |
|--------|--|
| Future | <ul style="list-style-type: none"> • Distribution networks • Biological organisms, ecologies • Market systems and economies • Health care delivery • Systems of conflict • Systems of innovation |
| Recent | <ul style="list-style-type: none"> • Ground Vehicles • Aircraft • Marine Vessels • Biological Regulatory Networks |

Traditional view:

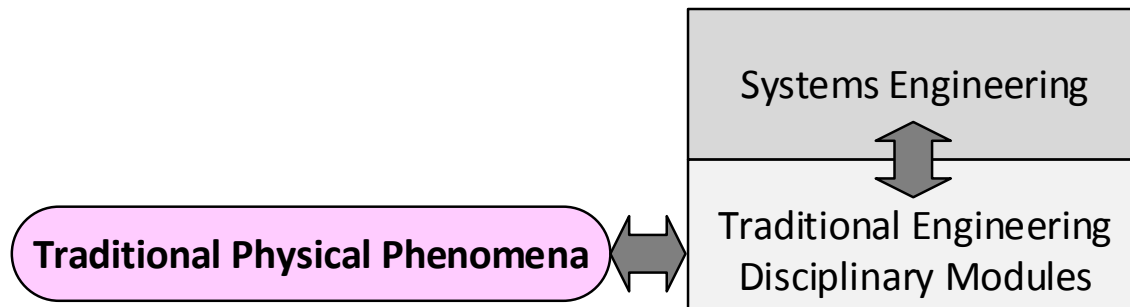

Future view:

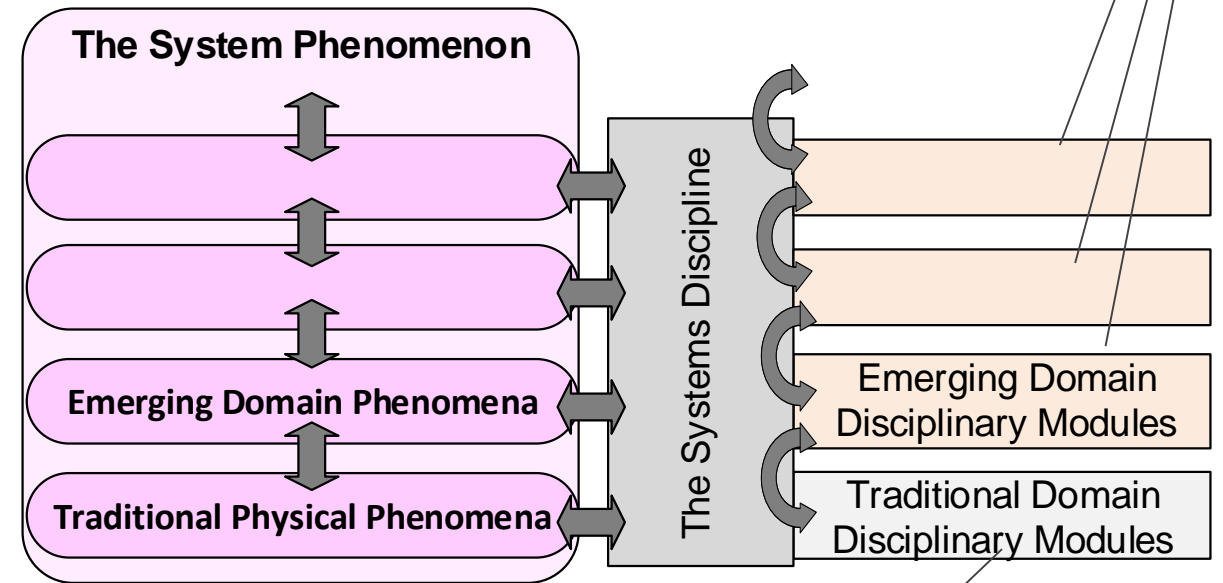

* Explaining after their discovery, but generally not predicting them before. See P. W. Anderson, Att. 1.

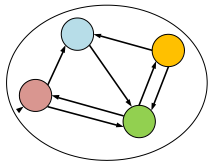

Impacts on Semantic Structure Emerge Uniquely for Each Emergent Domain

- | | |
|--------|--|
| Future | <ul style="list-style-type: none"> • Distribution networks • Biological organisms, ecologies • Market systems and economies • Health care delivery • Systems of conflict • Systems of innovation |
| Recent | <ul style="list-style-type: none"> • Ground Vehicles • Aircraft • Marine Vessels • Biological Regulatory Networks |

- New interactions (e.g., on the Internet) lead to new domains—each with new structure, new named things (roles), attributes, and relationships.
- Each new domain arising from new interactions thus creates a new ontology (domain specific language).
- So, a single “master ontology” is thus never enough!
- Domain ontologies are about semantic structure, not about quantitative mathematical aspects.
- Human skills and tools for language and meaning are called into play—different than quantitative skills and tools. Calls upon System Thinking.
- The related ontology frameworks thus have both structural semantic and quantitative math aspects.
- Here designers face a different “reverse” problem than scientists: Seeking to discover structure to produce interaction behaviors to deliver benefits (next section).

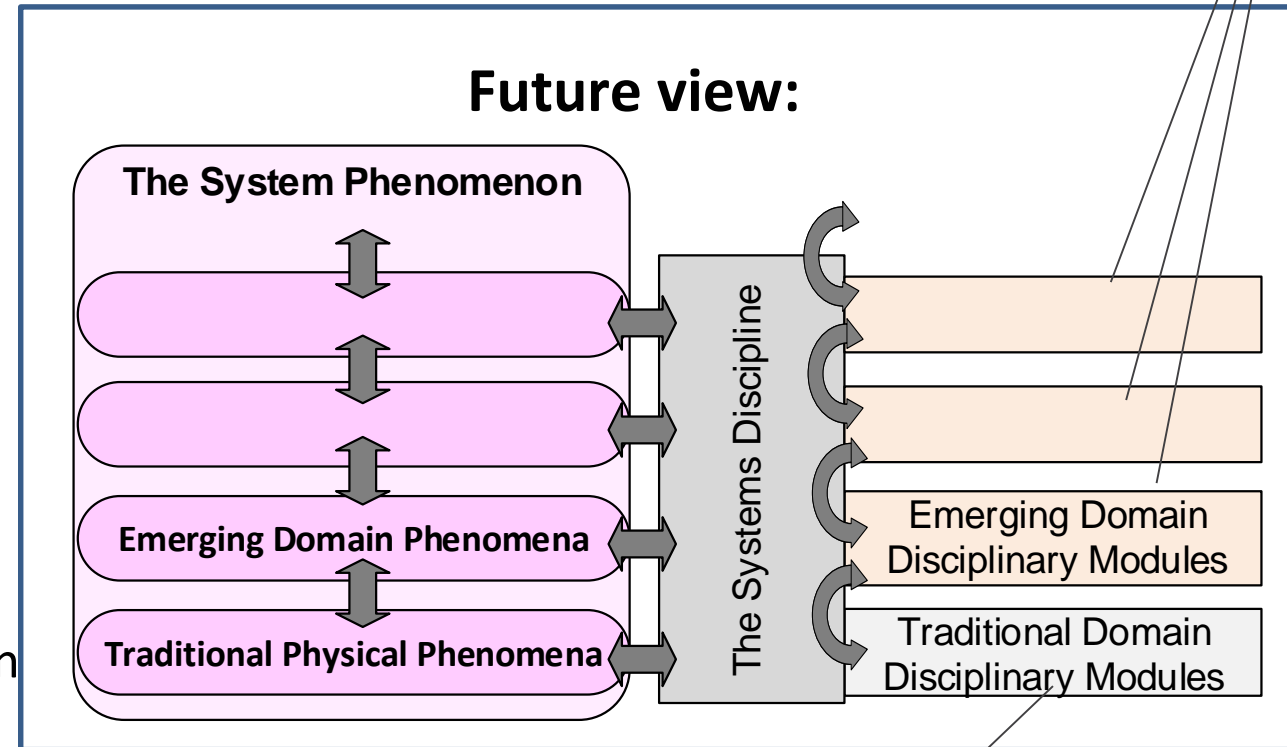

Three Real Phenomena That Are Key to SE Foundations

1. **The System Phenomenon**: Each of the traditional physical sciences is based on a specific physical phenomenon (mechanical, electrical, chemical, etc.) and related mathematical formulation of physical laws and first principles. What is the equivalent “hard science” phenomenon for systems, where is its mathematics, and what are the impacts on future SE practice? Are there also “soft” aspects?
2. **The Value Selection Phenomenon**: Engineers know that value is essential to their practice, but its “soft” or subjective nature seems challenging to connect to hard science and engineering phenomena. What is the bridge effectively connecting these, where is the related mathematics, and what are the impacts on future SE practice?
3. **The Model Trust by Groups Phenomenon**: The physical sciences accelerated progress in the last three centuries, as they demonstrated means for not just the discovery and representation of Nature’s patterns, but also the managed awarding of graduated shared trust in them. What is the scientific basis of such group learning, how is it related to machine learning, and how does it impact the future practice of SE?

2. The Value Selection Phenomenon



- Engineers know that value is essential to their practice, but its “soft” or subjective nature seems challenging to connect to hard science and engineering phenomena.
- System engineers currently learn to seek out and represent (may model in detail) stakeholder needs, measures of effectiveness, objective functions connected to derived requirements and technical performance, etc.--what value does your system contribute?
- This nearly always includes “conflicting” dimensions of value, when “trade space” value dimensions appear to trade against each other—as in performance vs. cost. The resulting balancing act led to notions of Pareto Frontiers and other multi-variate forms, Arrow’s Impossibility Theorem, and other formulations and insights.
- For many systems, lack of good knowledge (by even the customer) about value has changed engineering into a discovery project, as in Agile Methods, Minimum Viable Products, Pivoting, Hypothesis Experiments, and similar approaches. We will return to that subject in the Model Trust by Groups Phenomenon section.
- Meanwhile, what are the phenomena associated with value, what is the bridge between subjective value and objective science, where are the related mathematics and recurring patterns, and what are the impacts on future SE practice?
- What follows is not the same as simply “modeling idealized value”, which might seem natural but which has some challenges.

What is the distinction we are making here?

“Modeling Value” in the traditional sense (e.g., MOEs/Measures of Effectiveness, etc.) sounds a lot like “Modeling Value Selection”—**so what distinction we are making?**

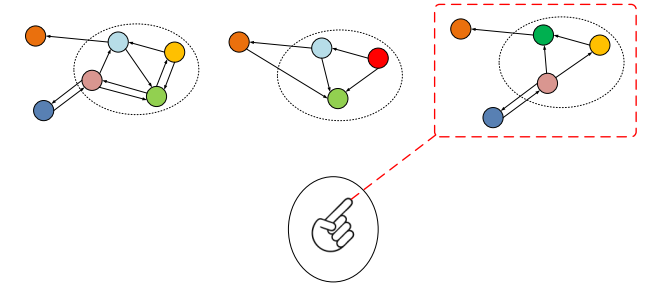

- This is where the “objective science” comes in!
- We are interested in models that can be tested in actual experiments with real selection agents.
- Systems engineering needs to catch up with what business has discovered and put into practice in recent years—driving discovery with real experiments that test the validity of hypothesized value, in a dynamic, pivoting enterprise.
- We are interested in what actual selection behavior tells us about value—not just what isolated offerings of opinion about value or statements of preference. What really gets selected?
- That is the distinction of the Value Selection Phenomenon.
- It is a real phenomenon that always occurs and can be observed.
- It also can be influenced by advertising, culture, context, bias.
- It can also help us engage the “multi-variate” value challenge.

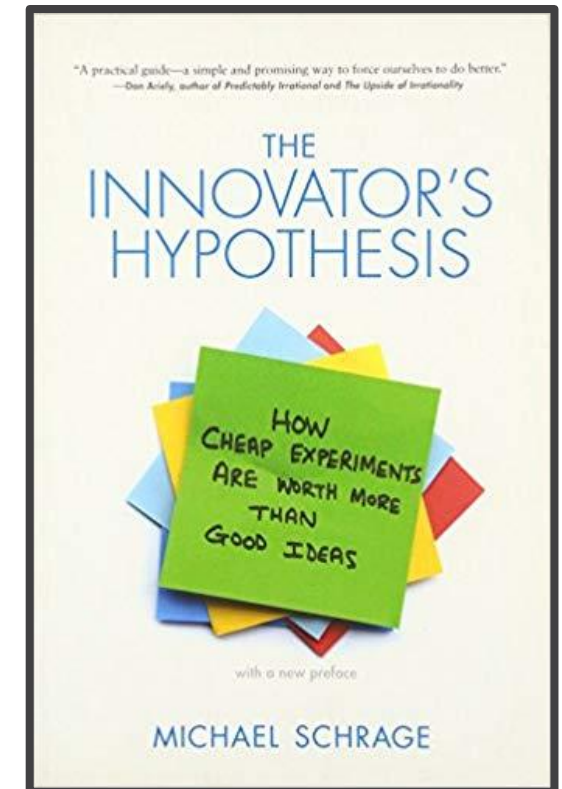

Even if value (both human-based and otherwise) seems elusive or subjective, the expression of value in the real world is always via selection, and selection itself is an *interaction-based instance of the System Phenomenon*:

Settings	Types of Selection	Selection Agents	
Consumer Market	Retail purchase selection	Individual Consumer; Overall Market	
Operational Use	Decision to use product A or use product B	User	
Military Conflict	Direct conflict outcome; threat assessment	Military Engagement	X
Product design	Design trades	Designer	
Commercial Market	Performance, cost, support	Buyer	
Biological Evolution	Natural selection	Environmental Competition	X
Product Planning	Opportunity selection	Product Manager	
Market Launch	Optimize choice across alternatives	Review Board	
Securities Investing	What to buy, what to sell, acceptable price	Individual Investor; Overall Market	
College-Student "Matching Market"	Selection of individuals, selection of class profile, selection of school	Admissions Committee; Student Family	
Life choices	Ethical, moral, religious, curiosities, interests	Individual	
Democratic election	Voting	Voters; Voting Blocks	
Business	Risk Management, Decision Theory	Risk Manager, Decision Maker	

Not all selection is by human agents

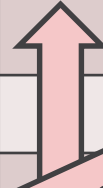

Performance Interactions vs. Selection Interactions

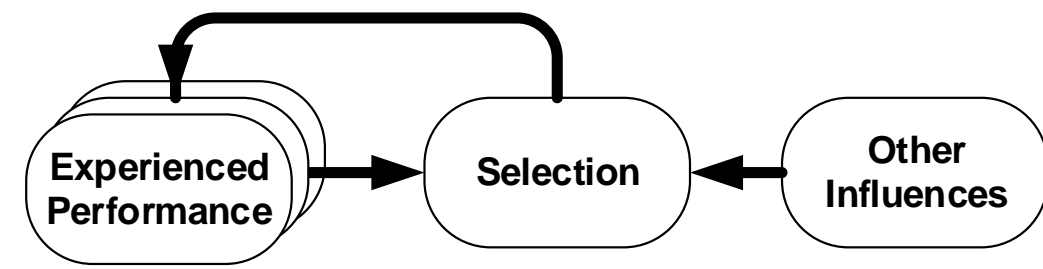

Value refers to Interactions of two very different types:

1. **Performance Interactions** (real or planned, present, past, future) embody and deliver Value from Performers (this is currently more familiar to systems engineers):
 - Example: The “ride” a passenger experiences, over a bumpy road in a vehicle.
 - An actually experienced, simulated, imagined, or promised performance interaction.
 - This might seem like what we’d want to model (and we should), but there is more than this alone.
2. **Selection Interactions** (human or otherwise) express the comparative Values of a Selection Agent, human or otherwise (familiar to consumer marketers, behavioral economics specialists, web-based experimentalists, big data specialists):
 - Example: The selection of a vehicle to buy, from among competing alternatives.
 - This is what we advocate also be modeled. It might seem it ought to produce the same result as above, but there is more to it. For example, what is the effect of advertising? Reference networks?

Here we are emphasizing selection outcome as the ultimate expression of value:

- Performance Interactions remain essential to representing the possible choices.
- Selection Interactions typically choose from across multiple dimensions all at once, in the real world.²⁷

Example: Selecting Vehicle "Ride"

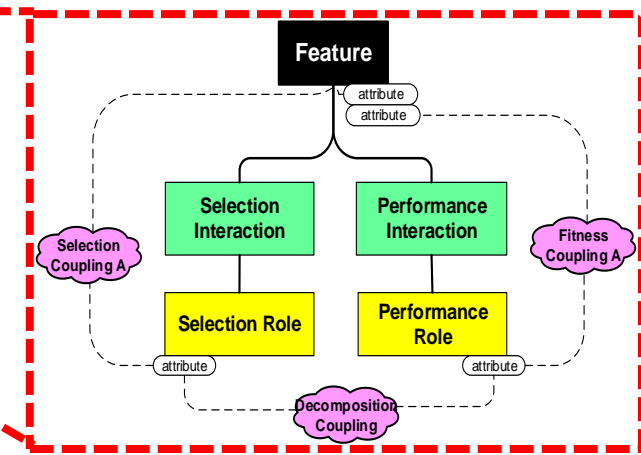
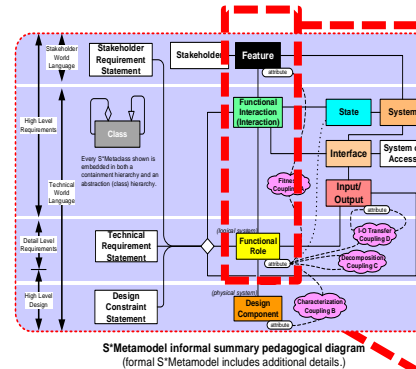

Comfortable Ride Feature

Experienced Ride
Market Acceptance

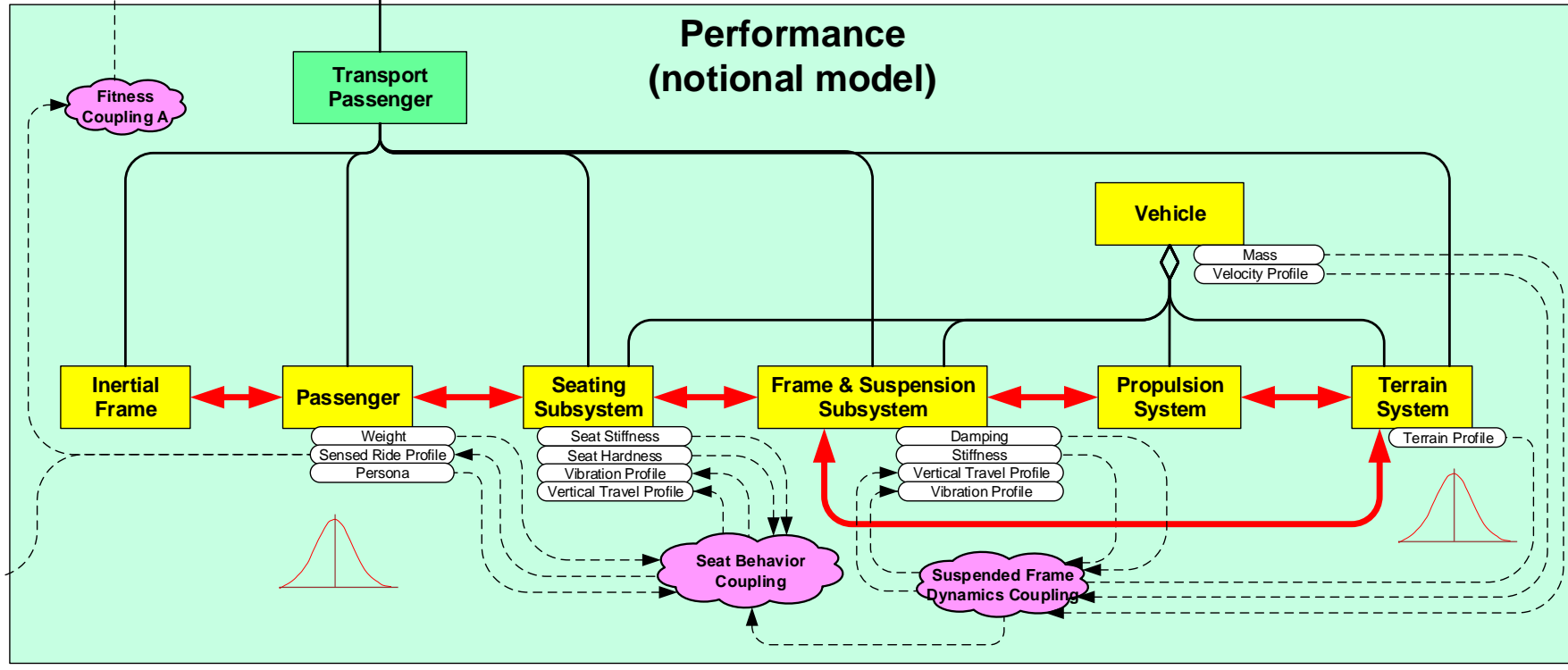
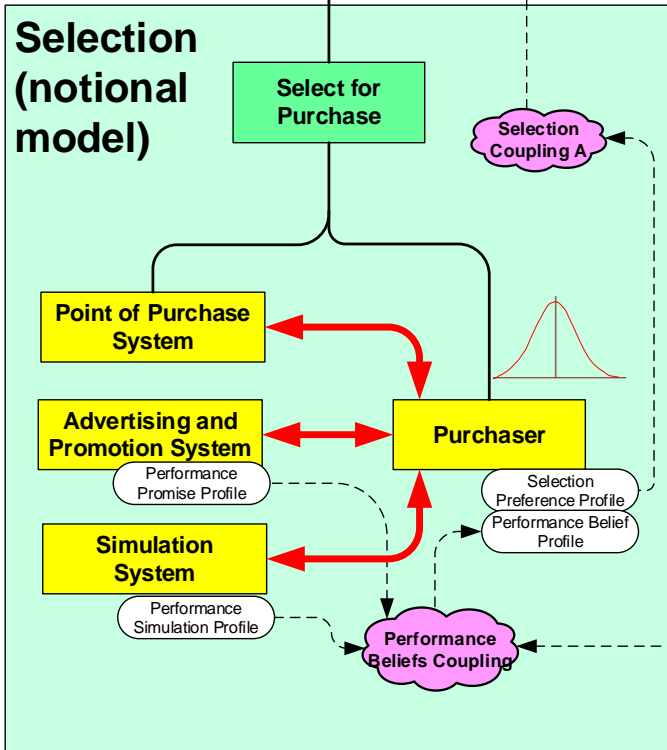

Value is not solely inherent to subject system's performance

- A performing system, moved from one country-culture-application-market segment to another, with no technical changes:
 - Could offer the very same technical performance (assuming the application/operating environment remained the same otherwise).
 - But is valued differently by the new and different stakeholders.
 - As their Selection behavior will ultimately express.
- The Selection Phenomenon is what we want to understand to quantify relative value, always expressed as selection:
 - As influenced in part by the Performance Interaction, . . .
 - But also by the nature and behavior of the Selection Agent, . . .
 - Which is impacted by past experience, learning and habituation, advertising and promotion, trends and fashion, peer groups, etc.
 - Much innovation has been occurring in those other spaces—such as choice and distribution through on-line and other non-traditional systems.

Human Subjectivity

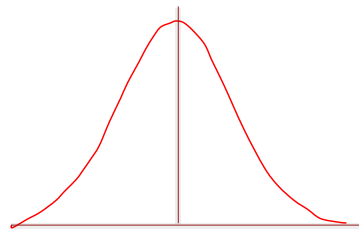

In this framework, human subjectivity appears in two different places:

1. A human may be a part of the Performance Interaction, and form sensory and mental perceptions about what performance is occurring—not its value. (e.g., Passenger in above example)
2. A human may be the Selection Agent in the Selection Interaction, acting on acquired beliefs about relative value. (e.g., Purchaser in above example)

The key insight: *Note that neither of these two parties is the **Modeler**:*

- The role of the Modeler is to discover, express, and validate models of both the Performance and Selection aspects of the systems at hand:
 - Whether those humans are flying aircraft or choosing products.
- This clearly involves modeling of human behaviors:
 - That should hardly be a surprise, after decades of impactful modeling, Nobel prize recognition, and now on-line machine learning and millions of confirming experiments, about the value-based behavior of humans making choices.

Human Subjectivity

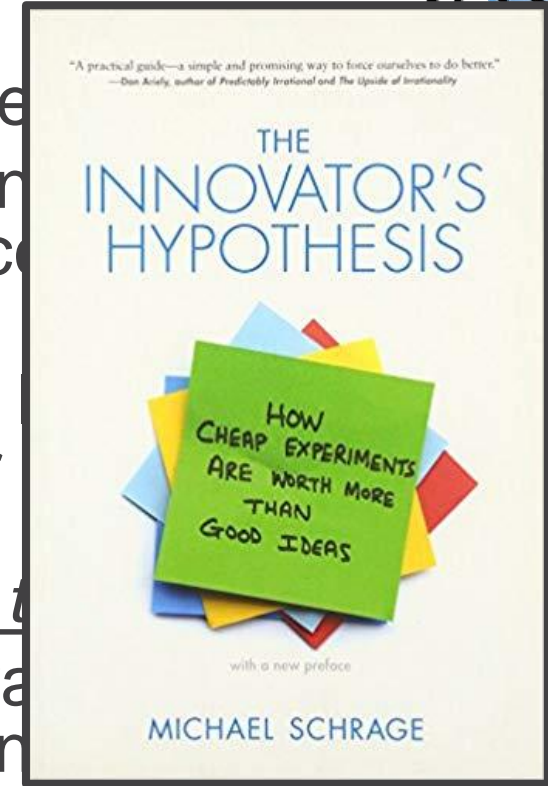
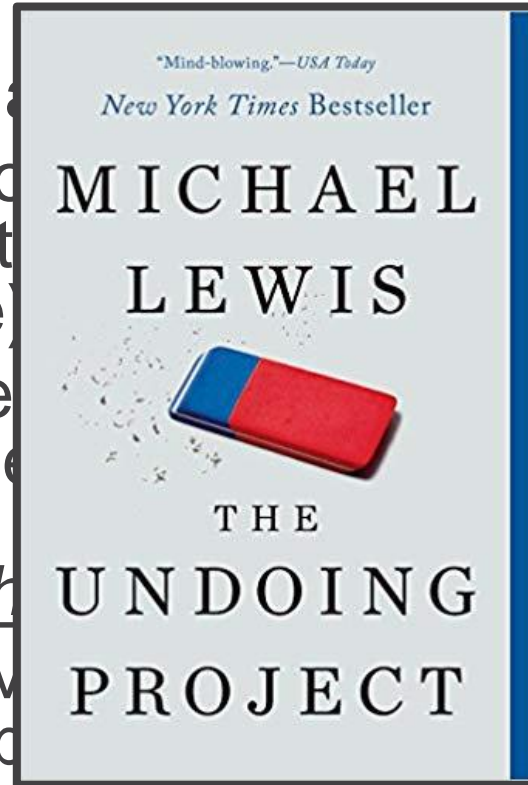
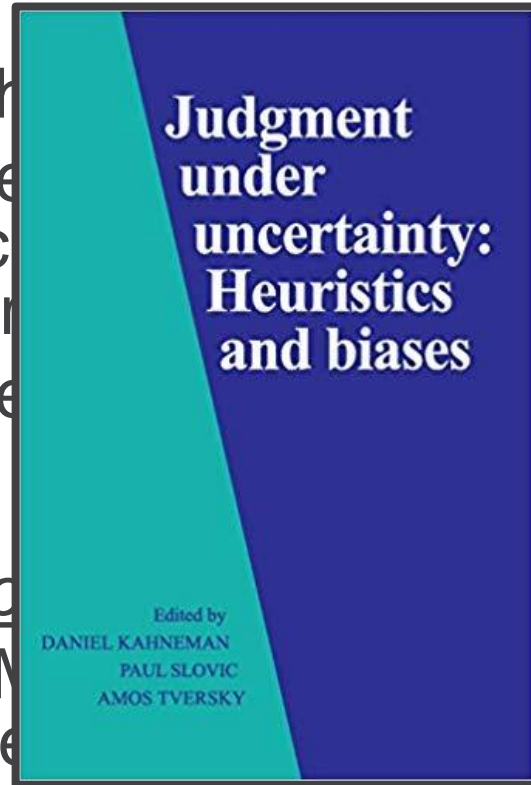
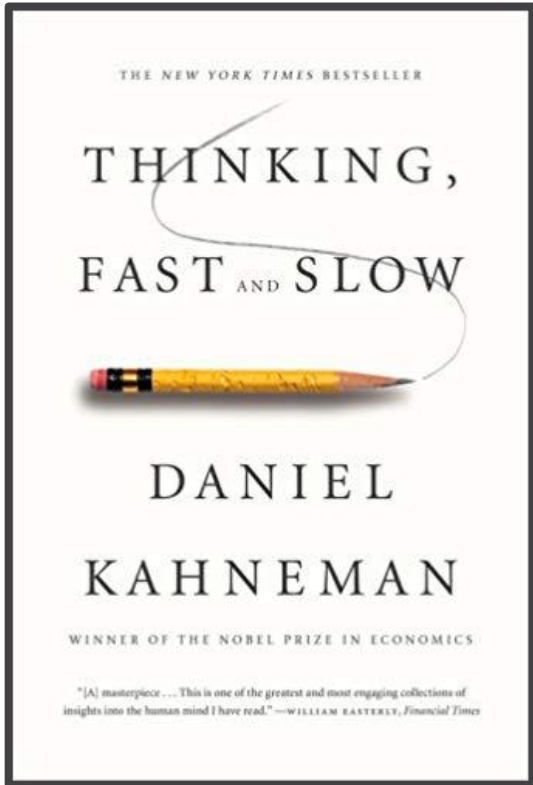

- Whether humans are flying aircraft, choosing products, or not humans.
- This clearly involves modeling of human behaviors:
 - That should hardly be a surprise, after decades of impactful modeling, Nobel prize recognition, and now on-line machine learning and millions of confirming experiments, about the value-based behavior of humans making choices.

Lessons from Biology and Agile Engineering: Where Do Systems Come From and Go? System Life Cycle Trajectories in S*Space

- Configurations change over life cycles, during development and subsequently
- Trajectories (configuration paths) in S*Space
- Effective tracking of trajectories
- History of dynamical paths in science and math
- Differential path representation: compression, equations of motion

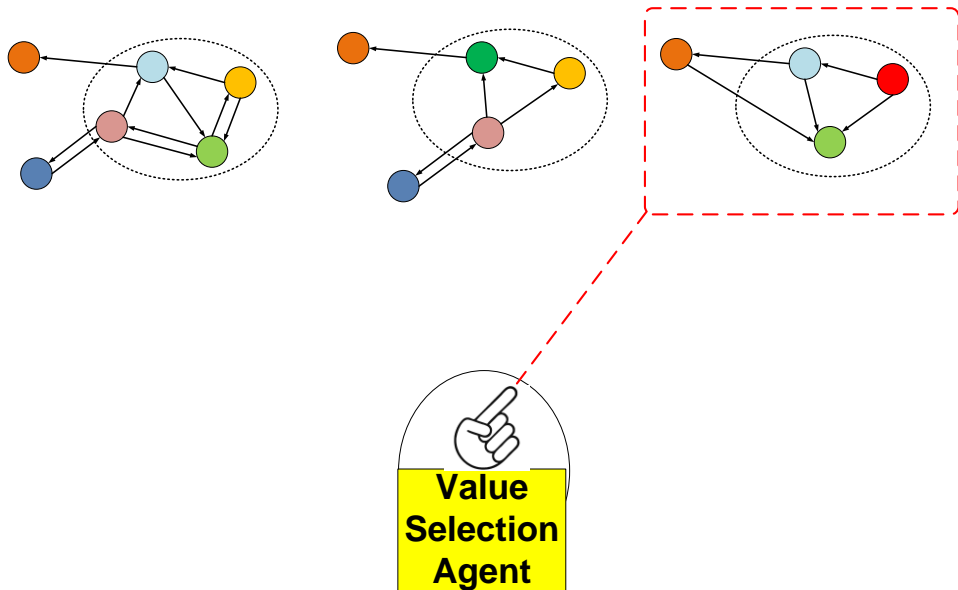

27th annual **INCOSE** International Symposium
Adelaide, Australia
July 15 - 20, 2017

SESA

Innovation, Risk, and Agility, Viewed as Optimal Control & Estimation

Bill Schindel
ICTT System Sciences
schindel@ictt.com

Copyright © 2017 by William D. Schindel. Published and used by INCOSE with permission

1.7.2

Innovation Trajectory Optimization, in Value Space

- Apply Optimal Estimation and Control Theory
- To Define Direction of Increments in Model Space (not Process Space)
- that Optimizes the Value Space Trajectory Traveled During Processes
- Includes considerations of Travel Time Schedule, Cost, Risk, System Performance



IN PROCESS SPACE:

- Organizes Process Concurrency / Agility,
- By optimizing the incremental model data trajectory in model configuration space

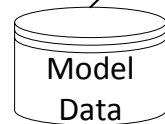
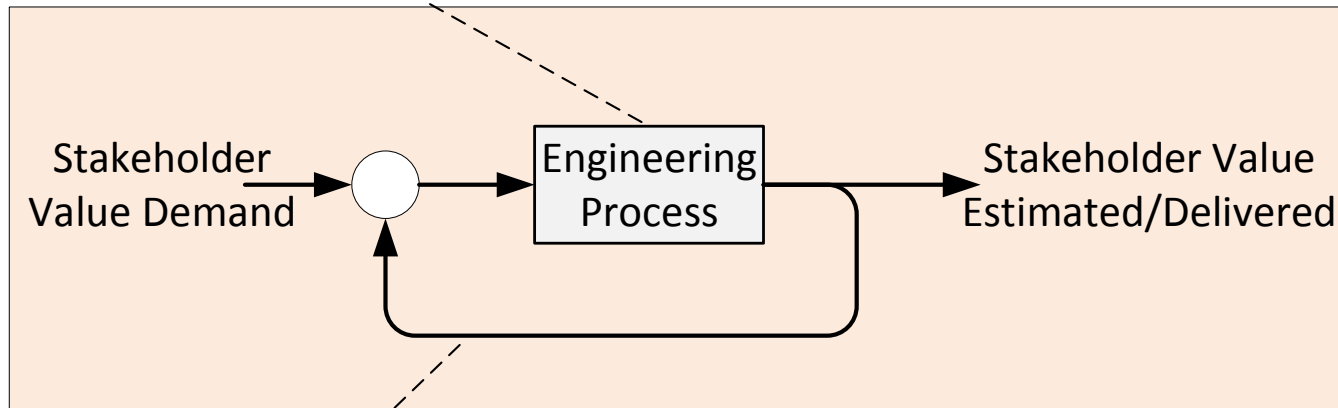

IN SYSTEM MODEL DATA SPACE:

- Mission & other Stakeholder Analysis/MOEs, including Risks, in Value Model Space
- System Requirements Analysis/TPMs, in Technical Performance Model Space
- Architecture Design, in Physical Design Space
- Trade-off Analyses
- System Verification/Validation Confidence

Three Real Phenomena That Are Key to SE Foundations

1. **The System Phenomenon**: Each of the traditional physical sciences is based on a specific physical phenomenon (mechanical, electrical, chemical, etc.) and related mathematical formulation of physical laws and first principles. What is the equivalent “hard science” phenomenon for systems, where is its mathematics, and what are the impacts on future SE practice? Are there also “soft” aspects?
2. **The Value Selection Phenomenon**: Engineers know that value is essential to their practice, but its “soft” or subjective nature seems challenging to connect to hard science and engineering phenomena. What is the bridge effectively connecting these, where is the related mathematics, and what are the impacts on future SE practice?
3. **The Model Trust by Groups Phenomenon**: The physical sciences accelerated progress in the last three centuries, as they demonstrated means for not just the discovery and representation of Nature’s patterns, but also the managed awarding of graduated shared trust in them. What is the scientific basis of such group learning, how is it related to machine learning, and how does it impact the future practice of SE?

Two Historical “Phase Changes” in Disciplines

1. Model-based phase change leading to traditional STEM disciplines:

- Beginning around 300 years ago (Newton’s time)
- Efficacy evidence argued from “step function” impacts on human life

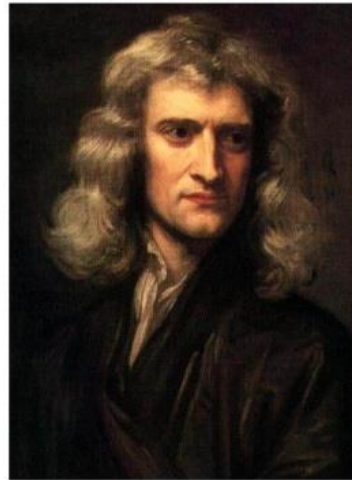

2. Model-based phase change leading to future systems disciplines:

- Beginning around our own time
- Evidence argued from foundations of STEM disciplines

Phase Change #1 Evidence: Efficacy of Phenomena-Based STEM Disciplines



In a matter of a 300 years . . .

- the accelerating emergence of Science, Technology, Engineering, and Mathematics (STEM) . . .
- has lifted the possibility, nature, quality, and length of life for a large portion of humanity . . .
- while dramatically increasing human future potential.
- By 20th Century close, strong STEM capability was recognized as a critical ingredient to individual and collective prosperity.
- See Att. 1 for evidentiary data.

A Standard of Performance for MBSE

- The “hard sciences”, along with the “traditional” engineering disciplines and technologies based on those sciences, may be credited with much of that amazing progress.
- When it comes to use of models, how should Systems Engineering be compared to engineering disciplines based on the “hard sciences”?

Engineering uses STEM Models to represent, predict, and explain

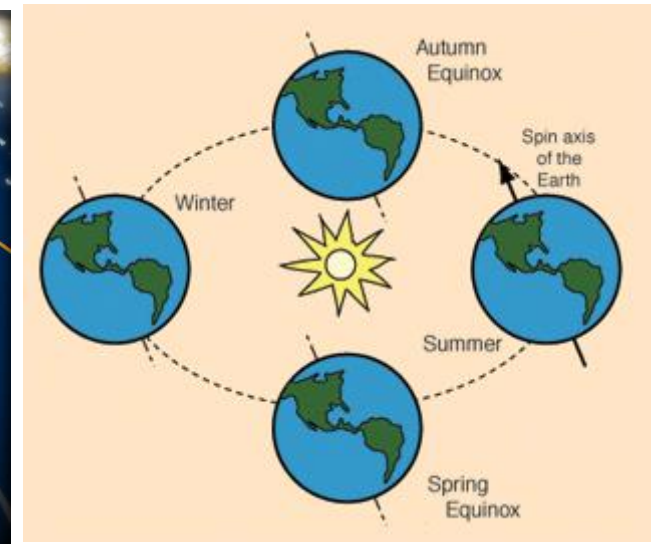
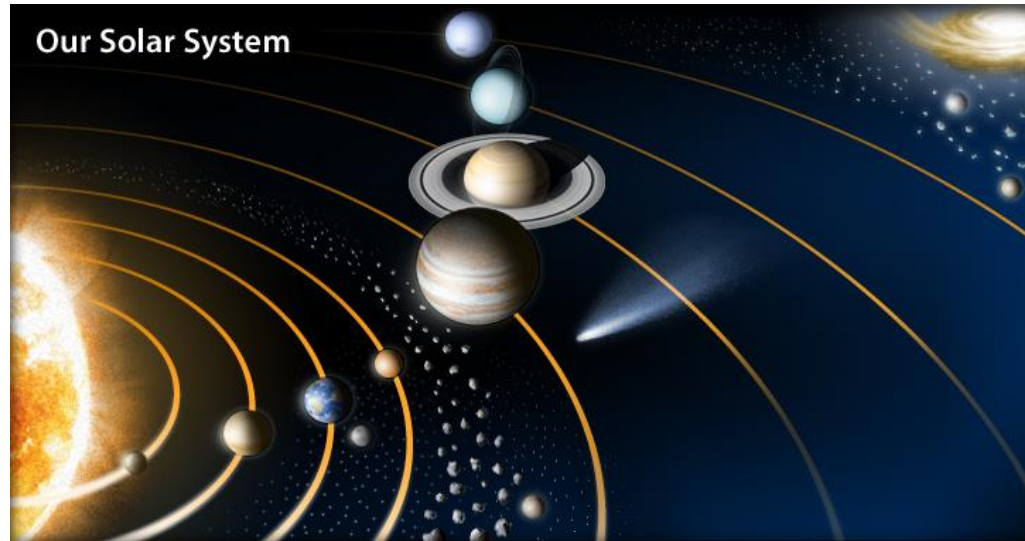
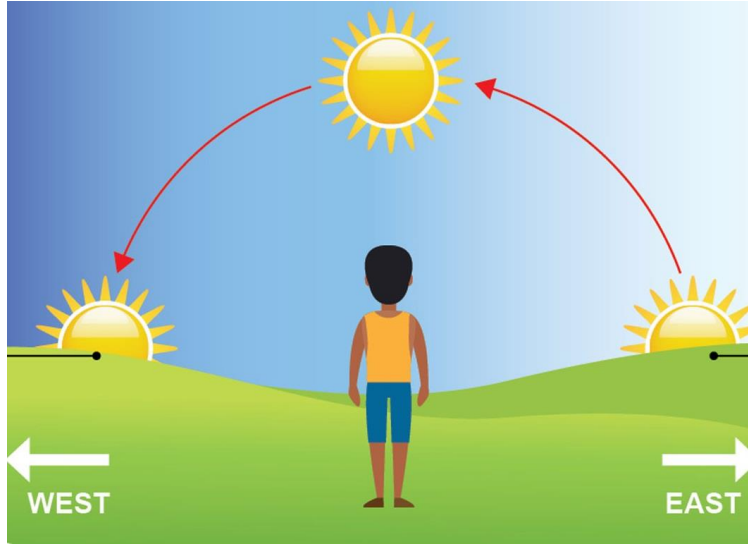

- Predict: For millennia, the evolving passage of sunrise, sunset, Lunar phases, and passage of the seasons has been reliably predicted based on learned, validated patterns, helping feed exploding human population. (Prediction models, not explanatory models.)
- Explain: By the time of Copernicus and Newton, science had provided improved explanations of the cause of these phenomena, to demonstrated levels of fidelity.
- Represent: A key to the jump in effectiveness of the “Explain” and “Predict” parts improved methods of representing subject matter, using explicit, predictive, testable mathematical models.
- Systems Engineering should demand the foundational elements of Systems Science to be similarly impactful.

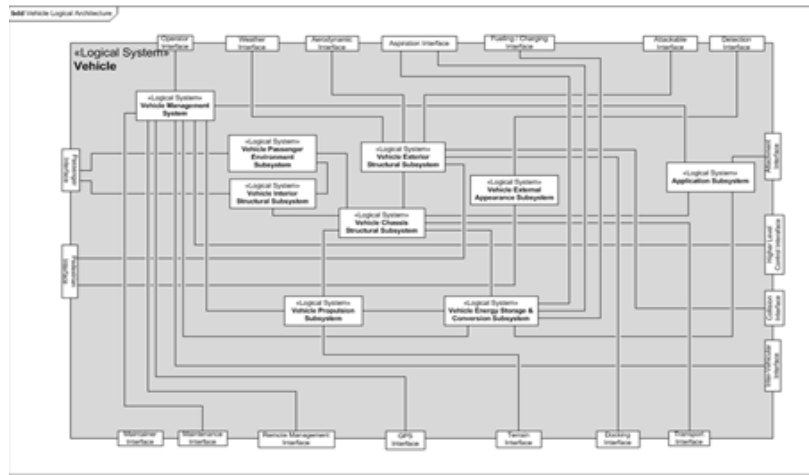

Phase Change #2: MBSE, PBSE, a phase change in SE

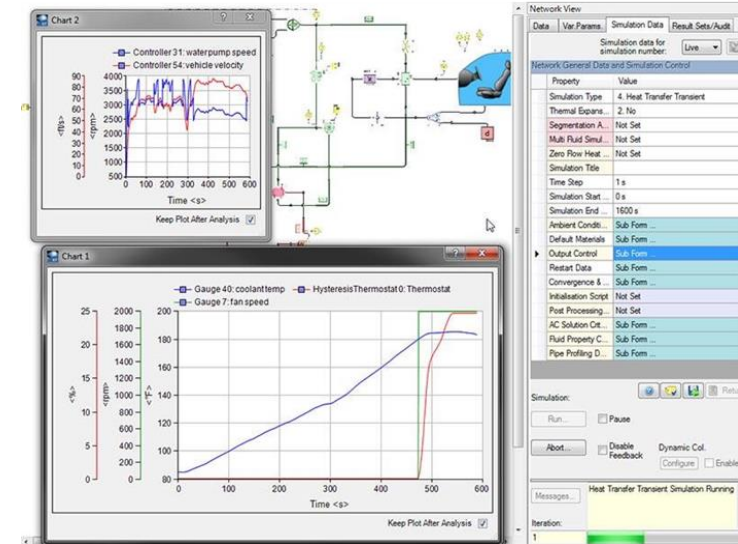

While models are not new to STEM . . .

- Model- Based Systems Engineering (MBSE): In recent decades, we increasingly represent our understanding of systems aspects using explicit models.
- Pattern-Based Systems Engineering (PBSE): We are beginning to express parameterized family System Models capable of representing recurring patterns -- in the tradition of the similarly mathematical patterns of science.
- This is a much more significant change than just the emergence of modeling languages and IT toolsets, provided the underlying model structures are strong enough: Remember physics before Newtonian calculus.
- We asserted earlier above the need to use mathematical patterns known 100+ years,

V&V of Models,
Per Emerging ASME Model V&V Standards

Does the Model adequately describe what it is intended to describe?

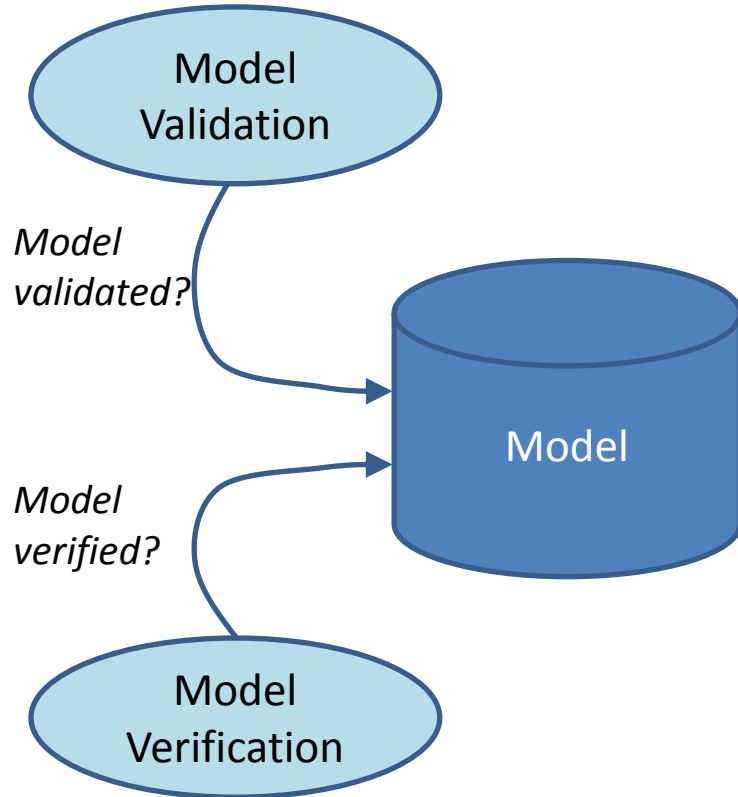

Does the Model implementation adequately represent what the Model says?

V&V of Systems,
Per ISO 15288 & INCOSE Handbook

Do the System Requirements describe what stakeholders need?

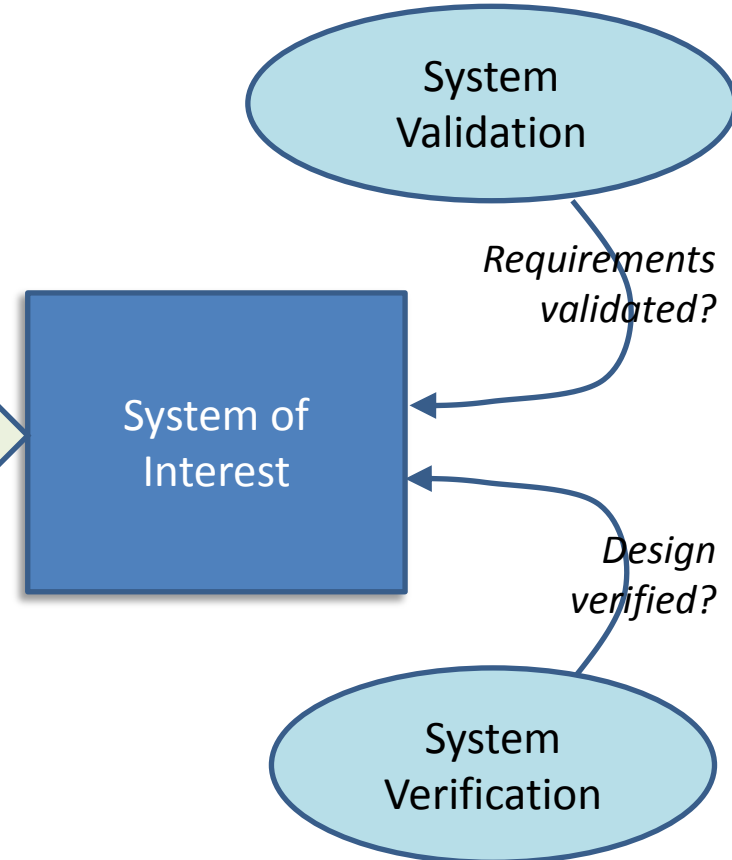

Does the System Design define a solution meeting the System Requirements?

Don't forget: A model (on the left) may be used for system verification or validation (on the right!)

If we expect to use models to support more critical decisions, then we are placing increased trust in models:

- Critical financial, other business decisions
- Human life safety
- Societal impacts
- Extending human capability

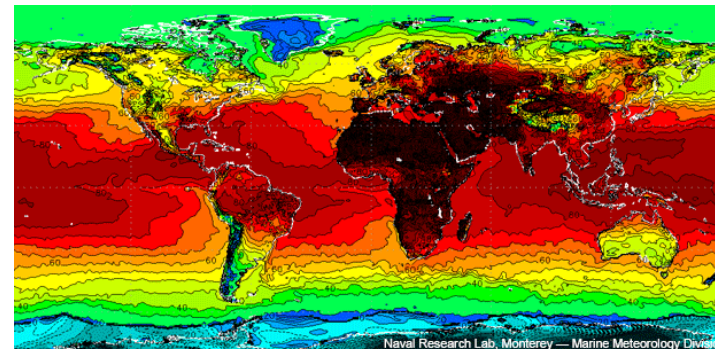

- Related risks require that we characterize the structure of that trust and manage it:
 - The Validation, Verification, and Uncertainty Quantification (VVUQ) of the models themselves.
 - Learned models from STEM (~300 years) offer a most dramatic example of positive collaborative impact of effectively shared & validated models

VVUQ: Model Credibility, including Uncertainty Quantification (UQ)

- There is a large body of literature on a mathematical subset of the Model VVUQ problem.
- Additional systems work is in progress, as to the more general VVUQ framework, suitable for general standards or guidelines – see the current ASME / INCOSE model VVUQ & credibility work.
- System models are part of this--scientifically-based trust is not awarded just by convincing someone your model looks good.
- Better quantification of model uncertainty, credibility, and maturity are all advancing.
- Increased V&V for critical models will raise the cost of those models.
- Makes use of trusted patterns more justifiable, the sharing of patterns more attractive.
- Credibility of models is connected to intended model uses, model influence, impacts.
- Increasingly autonomous systems present additional challenges to modelers.

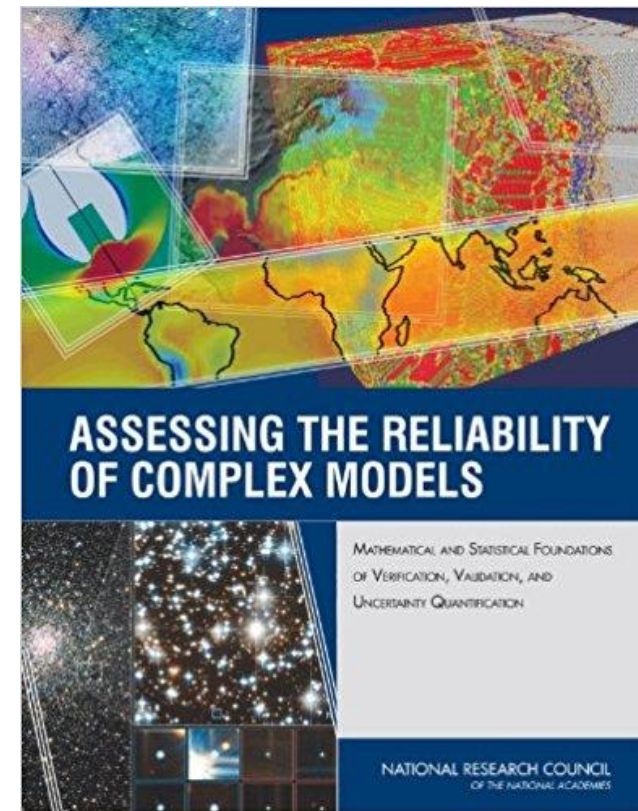

The Model Trust by Groups Phenomenon: Discovery/Learning by Humans and Machines

- ISO 15288 tells systems engineers all the kinds of information that must be found out over the life cycle of a system, but it is *relatively* silent on this question:
 - What about what I *already* know?
 - How do I effectively (not stumbling, repeating) mix what I already know with what *new things* I learn?
- This is a well-established question at the foundation of Bayesian Science.

- Models are formed here, in human brains or formalized models.
- Those models are validated here by formal methods or informal biological feedback.
- Levels of trust (and mistrust) are managed here, to label our confidence (or uncertainty) in what we have learned so far.
- We also discover new exceptions here, making further learning curve progress.
- “Deep learning” is not as new as one might think!

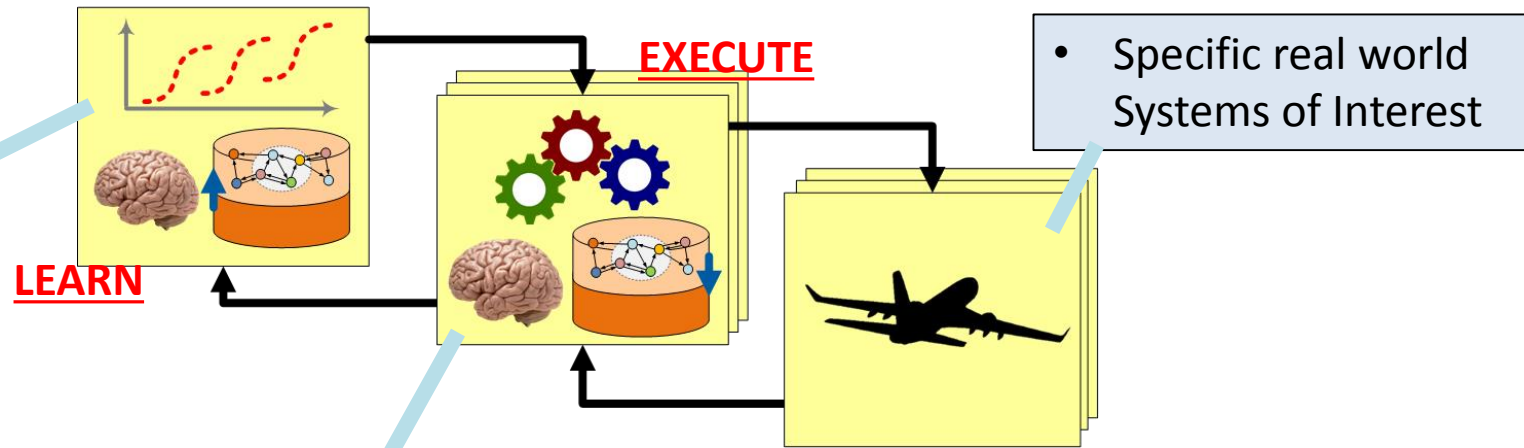

- Exploiting what has been learned as patterns (whether as informal biological patterns or formal model-based engineering patterns), we are in a position to rapidly (and more autonomously) configure those patterns as models for a specific instance target System of Interest.

- Specific real world Systems of Interest

Model Trust by Groups Phenomenon: The bigger picture

- Learning, validation, and use of trusted models over time, whether informal tribal knowledge or formalisms of engineering and science, is central to the programs of engineering and science.
- INCOSE has developed and applied a non-prescriptive reference pattern describing that frame, applicable from the most implicit to the most formal modeling engineering environments.
- It is the ASELCM Reference Pattern, and it contains ISO 15288 while also generalizing it.
- Concerned with how accumulated knowledge is combined with new learning, in the case of formalized MBSE it makes possible the unification of the Bayesian view of mathematical foundations of science with the practical frameworks of Systems Engineering.
- This pattern includes System 3, concerned with learning new things about engineering!

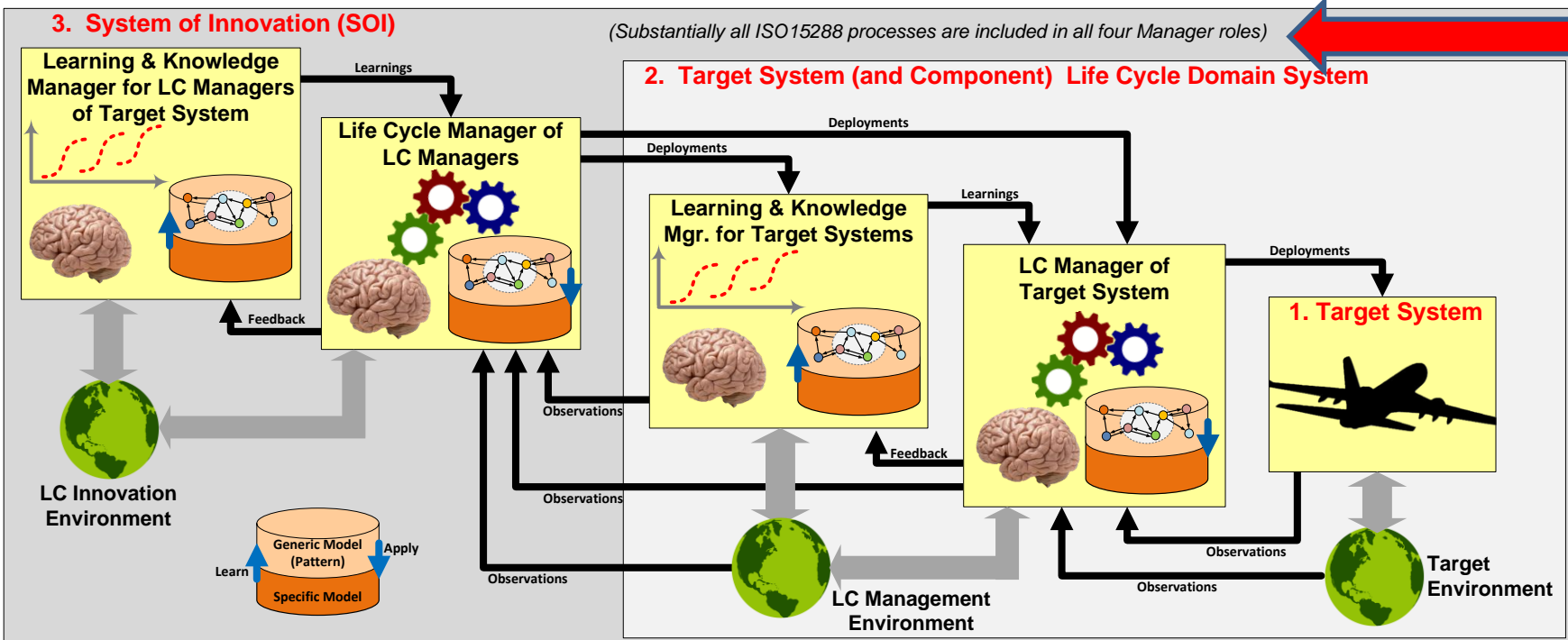

See Att. 1 and the Reference for more about the ASELCM Pattern.

Model Trust by Groups Phenomenon: About Group Learning

- Science and Engineering are social endeavors: The group phenomenon of team science and engineering are central to storied history of science and engineering (Khun, Brooks, etc.).
- Explicit models provide a “shared space” for which model validation becomes a proxy for group learning—central to the history of science (group learning about nature), but also critical to the success of engineering teams (group learning about patterns of customer need and other context, systemic behaviors, and technology design patterns).

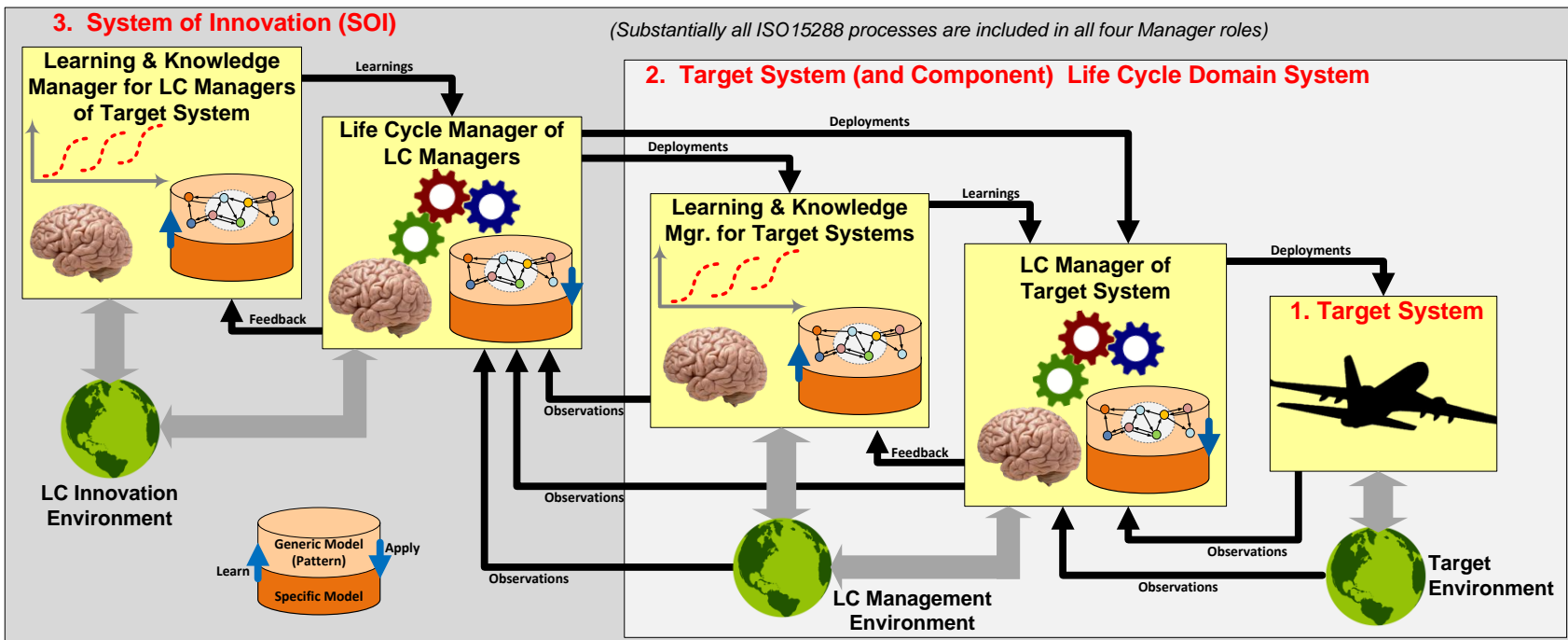

Gaining the system community segments' consensus toward impactful theoretical foundations is itself such a group learning social endeavor!

Implications for Practitioners, Educators, Researchers

1. Representing the System Phenomenon
2. The burden of model credibility
3. Systems education for all engineers
4. Systems research frontiers, needs, and opportunities

1. Practitioners: Representing the System Phenomenon

- Interactions are the phenomenon-based center of three centuries of highly impactful science and engineering.
- They should appear center stage in every system model; including external context interactions, internal design interactions, interactions with (and between) humans, and with (as well as between) software components.
- No naked behavior: Interactions are more than unipolar Functions (Functional Roles), also present.
- In hard and soft system models, tooling, views.
- Using complete enough metamodels and frameworks to support.

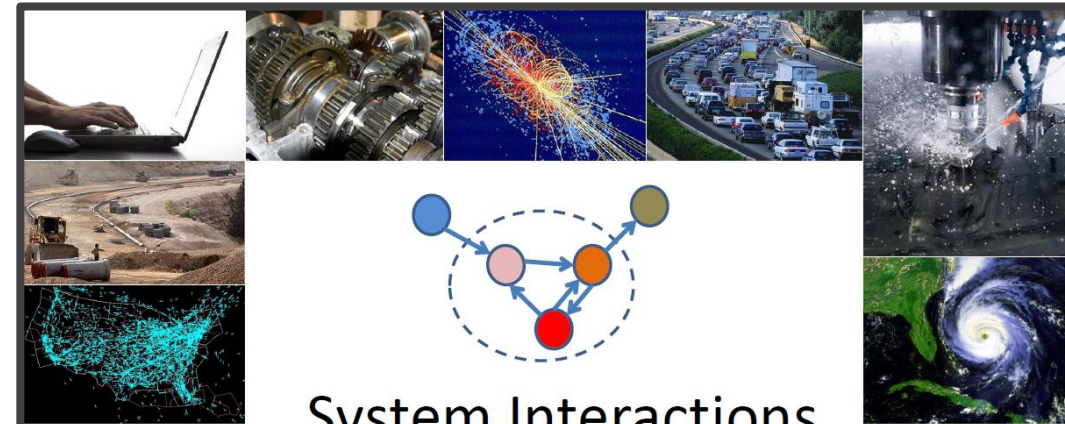
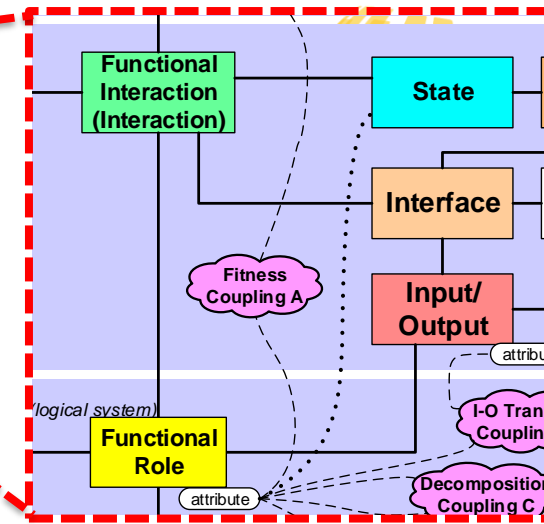
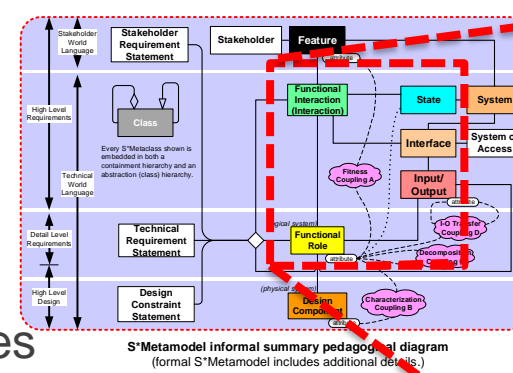
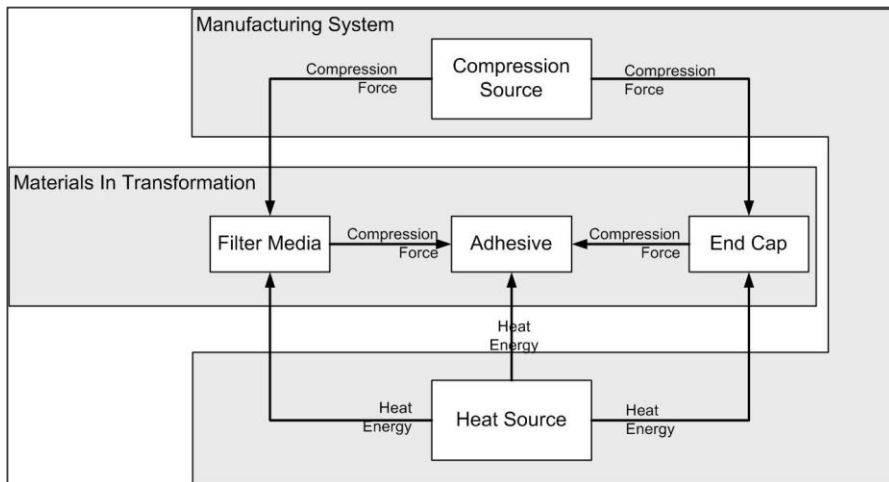

System Interactions

Making the Heart of Systems More Visible

William D. Schindel

ICTT System Sciences schindel@icct.com

2. Practitioners: The burden of model credibility

“It doesn't matter how beautiful your theory is, it doesn't matter how smart you are. If it doesn't agree with experiment, it's wrong.”

– Richard P. Feynman

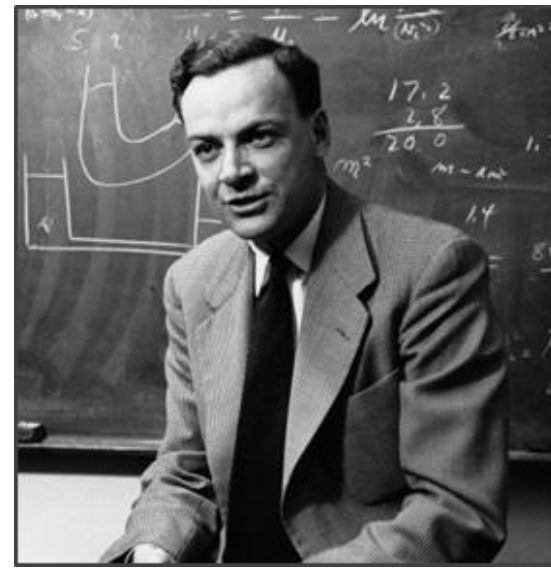

MBSE models are not exempt. See current ASME model credibility work joined by INCOSE, FAA, FDA, NRC to apply the Model Wrapper, CAFs, and leverage of trusted MBSE Patterns

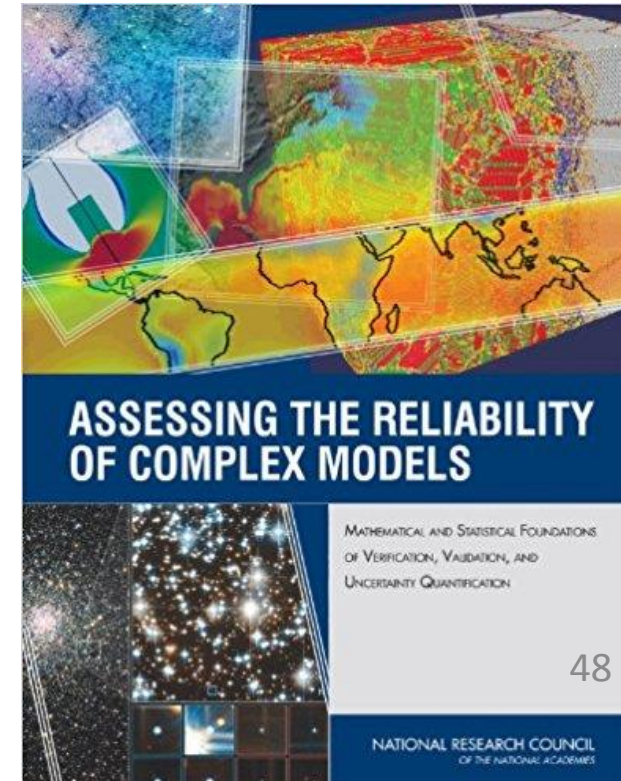
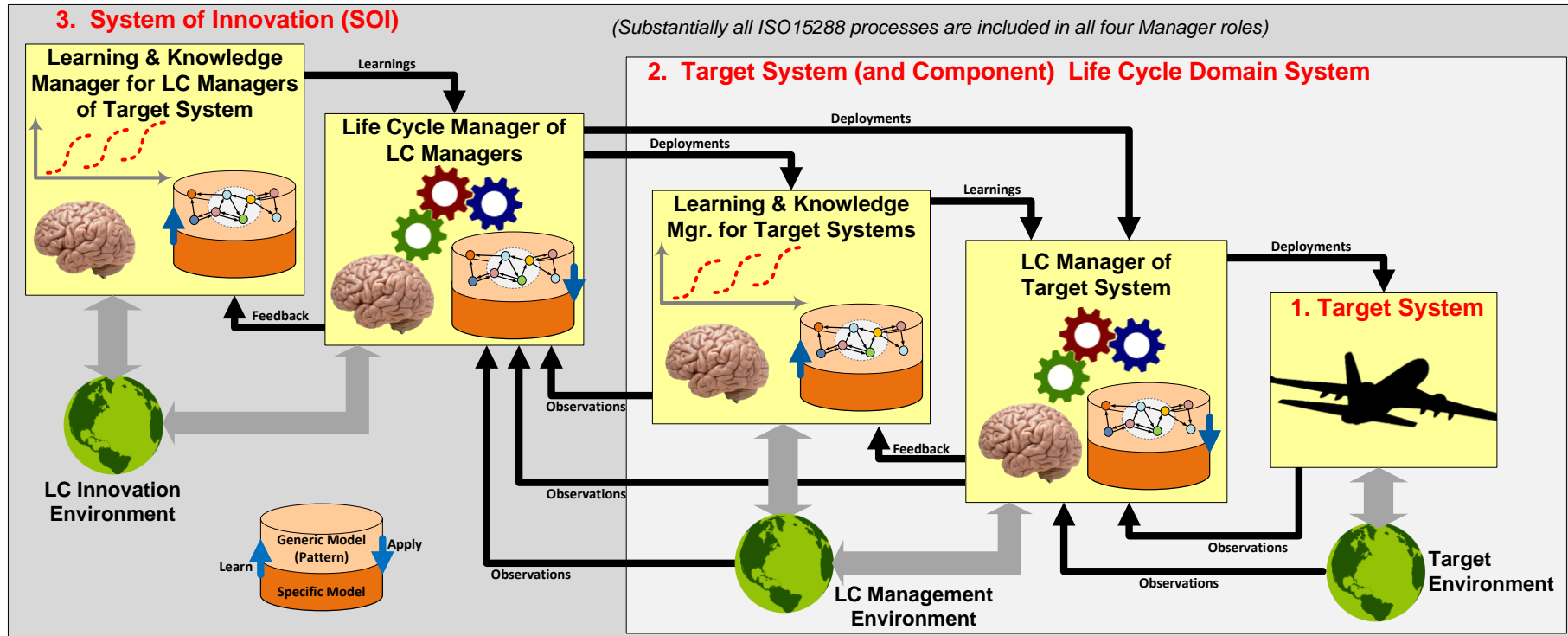

3. Systems education for all engineers

- “Tiny” system models (including interactions, value) build system skills for undergraduate engineering students across disciplines—not just for SE majors.
- Particularly effective in cross-disciplinary programs.
- Model-making as a skill first, later building deeper system sense.
- Lessons from the Conway & Mead VLSI methods revolution

26th Annual INCOSE International Symposium (IS 2016)
Edinburg, Scotland, UK, July 18-21, 2016

Helping Undergraduate Students of any Engineering Discipline Develop a Systems Perspective

Mario Simoni
Rose-Hulman Institute of Technology
5500 Wabash Ave, Terre Haute, IN 47803
(812) 877-8341
simoni@rose-hulman.edu

Eva Andrijcic
Rose-Hulman Institute of Technology
5500 Wabash Ave, Terre Haute, IN 47803
(812) 877-8893
andrijc@rose-hulman.edu

Bill Kline
Rose-Hulman Institute of Technology
5500 Wabash Ave, Terre Haute, IN 47803
(812) 877-8136
bkline@rose-hulman.edu

Ashley Bernal
Rose-Hulman Institute of Technology
5500 Wabash Ave, Terre Haute, IN 47803
(812) 877-8623
abernal@rose-hulman.edu



Paper ID #19345

Development of Enhanced Value, Feature, and Stakeholder Views for a Model-Based Design Approach

Dr. William A Kline, Rose-Hulman Institute of Technology

Bill Kline is Professor of Engineering Management and Associate Dean of Innovation at Rose-Hulman. His teaching and professional interests include systems engineering, quality, manufacturing systems, innovation, and entrepreneurship. As Associate Dean, he directs the Branam Innovation Center which houses campus competition teams, maker club, and projects.

He is currently an associate with IOI Partners, a consulting venture focused on innovation tools and systems. Prior to joining Rose-Hulman, he was a company co-founder and Chief Operating Officer of Montronix, a company in the global machine monitoring industry.

Bill is a Phi Beta Kappa graduate of Illinois College and a Bronze Tablet graduate of University of Illinois at Urbana Champaign where he received a Ph.D. degree in Mechanical Engineering.

Mr. William D. Schindel, ICTT System Sciences

William D. Schindel is president of ICTT System Sciences, a systems engineering company, and devel-

4. Systems research frontiers, needs, and opportunities

Abstract Theories of Systems: A great deal of math/science already exists here (even if overlooked) from 300 years of progress. Better we should be learning it and using it than searching for a replacement. Better to invest more systems research in the emerging domains' system phenomena.



- Future
 - Distribution networks
 - Biological organisms, ecologies
 - Market systems and economies
 - Health care delivery
 - Systems of conflict
 - Systems of innovation
- Recent
 - Ground Vehicles
 - Aircraft
 - Marine Vessels
 - Biological Regulatory Networks

Each emerging domain framework has its own patterns of foundational structures. (Same as chemistry, gas laws, electromagnetics, etc.) There are countless research opportunities to discover those system domain patterns and their related mathematics, and apply them for the good of each domain. (See P. Anderson; R. Laughlin.) 50

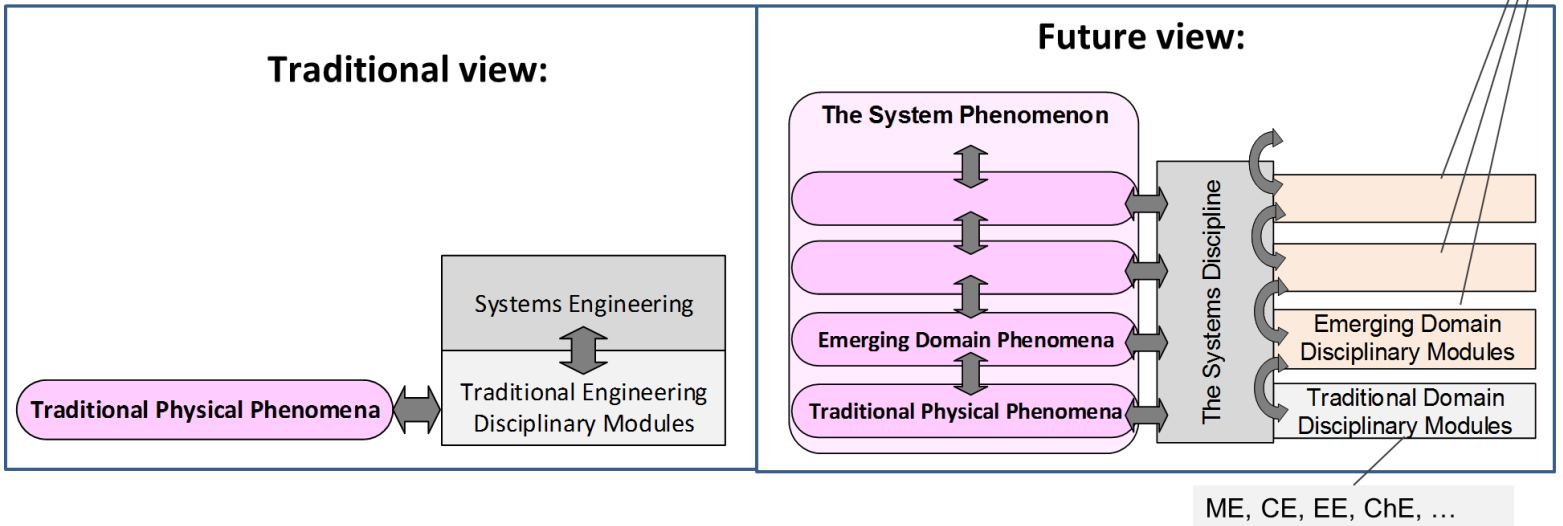

More Implications: Accelerating Impact, Harvesting Near-Term Benefits, Supporting the Revolution to Follow

Practitioners:

1. Representing the System Phenomenon, using complete enough models and frameworks
2. Face the burden of credibility for system models—apply the Model Wrapper, CAFs, and leverage of trusted MBSE Patterns
3. Orchestrate qualitative and quantitative modeling, system thinking, domain languages, simulation, context models
4. Understand the exploitation of modeled patterns as learning and risk management proxies, and the pattern life cycle beginning with uncover
5. Build understanding and skills differentiating uncertainty from random processes; understand Bayesian vs. Frequentist viewpoints
6. Representing value and its extended implications in Stakeholder Features, Risk Management, FMEAs, and Product Line Partitioning.
7. Continuous value experiments with customers.
8. Differentiate secured versus shared IP using the related pattern configuration constructs.
9. Understanding and advancing the Virtual Ecosystem using the ASELCM reference pattern's S3 “dual operating system” and S2 experiments
10. Understand the social aspect of engineering and models, use appropriate views, tools model curators and trusted model interpreters
11. Understand that change is also a social endeavor, requiring related skills, assets, resources
12. Plan the future based on lessons from past revolutions, translated to ASELCM S3.
13. Understand the roles of practitioners in the (comparable) VLSI revolution

More Implications: Accelerating Impact, Harvesting Near-Term Benefits, Supporting the Revolution to Follow

Educators:

1. Teach interaction modeling, illustrated by the last ten years of related undergraduate cross-discipline experiment
2. Understand the roles of educators in the (comparable) VLSI revolution
3. Employ in the classroom the pattern discoveries of research and practice
4. Experiments apply to the classroom, too—learning what patterns merit trust.

Researchers:

1. Balance general systems research priorities with emerging domain specific impactful research
2. Understand the roles of researchers in the (comparable) VLSI revolution
3. Do experiments in educational methods, not just engineering methods
4. Express S2 and S3 research results with respect to a common (e.g., ASELCM) reference ecosystem framework, including trans-disciplinary cases.
5. Include S2 qualitative methods research, including human factors of SE itself and other S2 humans.

Q&A, Discussion



-
-
-
-
-
-
-

References: The System Phenomenon

Analytical mechanics and generalizations that followed:

1. Rojo, A., and Bloch, A. (2018). *The Principle of Least Action: History and Physics*, Cambridge U Press.
2. Lanczos, C. (1970). *The Variational Principles of Mechanics*, U. of Toronto Press, Fourth Edition.
3. ----- (1970). *Space Through the Ages: The Evolution of Geometrical Ideas from Pythagoras to Hilbert and Einstein*, AP, London.
4. Morin, D. (2007). *Introduction to Classical Mechanics*, Cambridge U Press, 2007.
5. Sieniutycz, S., and Farkas, H., eds. (2005). *Variational and Extremum Principles in Macroscopic Systems*, Elsevier, Oxford, UK..
6. Lind, D., and Marcus, B. (1995). *An Introduction to Symbolic Dynamics and Coding*, Cambridge U Press.
7. Hey, A., ed. (1999). *Feynman and Computation: Exploring the Limits of Computers*, Perseus Books, Cambridge, MA.
8. Feynman, R., and Hibbs (1965). A., *Quantum Mechanics and Path Integrals*, McGraw-Hill, New York.
9. Anderson, P. (1972). More Is Different: Broken Symmetry and the Nature of the Hierarchical Structure of Science, *Science* 04 Aug 1972: Vol. 177, Issue 4047, pp. 393-396 DOI: 10.1126/science.
10. Laughlin, R. (2006). *A Different Universe: Reinventing Physics from the Bottom Down*, Basic Books.

What are the equivalent Systems Engineering constructs?

11. Schindel, W. (2013). Interactions: Making the Heart of Systems More Visible, *Proc. of INCOSE 2013 Great Lakes Regional Conference*. Retrieved from http://www.omgwiki.org/MBSE/lib/exe/fetch.php?media=mbse:patterns:system_interactions--making_the_heart_of_systems_more_visible_v1.2.2.pdf
12. ----- (2011). What is the Smallest Model of a System? *Proc. of the INCOSE 2011 International Symposium*, International Council on Systems Engineering, 21(1), 99–113. San Diego, CA: INCOSE.
13. ----- (2016). Got Phenomena? Science-Based Disciplines for Emerging Systems Challenges. *Proc of INCOSE International Symposium*, 26(1), 2256–2271. <https://doi.org/10.1002/j.2334-5837.2016.00293.x>
14. ----- (2018). The System Phenomenon, Hamilton's Principle, and Noether's Theorem as a Basis for System Science. *Proc. of ISSS2018 Conference*, Corvallis, OR, July, 2018.
15. ----- (2019). Identifying Phenomenological Foundations of Systems Engineering and Systems Science. *Systems Research and Behavioral Science*, 36(5).

References: The Value Selection Phenomenon

1. Michael Schrage (2014). *The Innovator's Hypothesis: How Cheap Experiments Are Worth More Than Good Ideas*, MIT Press.
2. Clarke, Ben, "Why These Tech Companies Keep Running Thousands of Failed Experiments", *Fast Company*, Sep 26, 2016.
3. Ronny Kohavi, Thomas Crook, Roger Longbotham, Brian Frasca, Randy Henne, Juan Lavista Ferres, Tamir Melamed, "Online Experimentation at Microsoft", retrieved from: <http://www.exp-platform.com/documents/expthinkweek2009public.pdf>
4. J Dyer, C Christensen, H. Gregersen (2011) *The Innovators DNA: Mastering the Five Skills of Disruptive Innovators*, HBR Press.
5. Buede, D., and Miller, W. (2016). *The Engineering Design of Systems: Models and Methods*, 3rd Edition. Wiley.
6. Website of Save, International, the Value Engineering Society: <https://www.value-eng.org>
7. Ries, Eric(2011) *The Lean Startup: How Today's Entrepreneurs Use Continuous Innovation to Create Radically Successful Businesses*, Crown Business, New York (US).
8. Manzi, James (2012) *Uncontrolled: The Surprising Payoff of Trial-and-Error for Business, Politics, and Society*, Basic Books, NY.
9. Petroski, H. (1993). *The Evolution of Useful Things*, Knopf.
10. Schindel, W. (2013). Systems of Innovation II: The Emergence of Purpose, in *Proc. of INCOSE 2013 International Symposium*, Philadelphia, PA.
11. ----- (2017). Innovation, Risk, Agility, and Learning, Viewed as Optimal Control & Estimation. In Proc of 2017 International Symposium. Adelaide, AU.
12. ----- (2017). "Fail-Fast Rapid Innovation Concepts", INCOSE Enchantment Chapter Socorro Systems Summit– Collaborative Knowledge Exchange. Socorro, NM.
13. Bryson, Arthur, and Ho, Yu-Chi (1975) *Applied Optimal Control: Optimization, Estimation, and Control*, Taylor & Francis, (US).
14. Bellman, R.E, Kalaba, R.E. (1959) 'Dynamic Programming and Feedback Control', RAND Corp.

References: The Model Trust by Groups Phenomenon

Trustable Models

1. Hightower, Joseph (2017) “Establishing Model Credibility Using Verification and Validation”, INCOSE MBSE Workshop, IW2017, Los Angeles, January, 2017. Retrieve from http://www.omgwiki.org/MBSE/lib/exe/fetch.php?media=mbse:incose_mbse_iw_2017:models_and_uncertainty_in_decision_making_rev_a.pptx
2. Schindel, W. (2018). Standardizing V&V of Models: INCOSE Collaboration In an ASME-Led Standards Activity, INCOSE International Workshop 2018, Jacksonville, FL. Retrieve from http://www.omgwiki.org/MBSE/lib/exe/fetch.php?media=mbse:patterns:standardizing_v_v_of_models_iw2018_mbse_workshop_report_01.21.2018_v1.2.1.pdf
3. *Assessing the Reliability of Complex Models: Mathematical and Statistical Foundations of Verification, Validation, and Uncertainty Quantification* ISBN 978-0-309-25634-6 THE NATIONAL ACADEMIES PRESS, <http://nap.edu/13395>
4. Oberkampf, W., and Roy, C., *Verification and Validation in Scientific Computing*, Cambridge U. Press, November 22, 2010.
5. “ASME V&V 10-2006: Guide for Verification and Validation in Computational Solid Mechanics”, ASME, 2006.
6. “ASME V&V 20-2009: Standard for Verification and Validation in Computational Fluid Dynamics and Heat Transfer”, ASME, 2009.
7. “ASME V&V 10.1-2012: An Illustration of the Concepts of Verification and Validation in Computational Solid Mechanics”, ASME, 2012.
8. *Journal of Verification, Validation, and Uncertainty Quantification*, ASME. <https://verification.asmedigitalcollection.asme.org/journal.aspx>
9. AIAA (American Institute for Aeronautics and Astronautics). 1998. *Guide for the Verification and Validation of Computational Fluid Dynamics Simulations*. Reston, Va.
10. “Heuristics for Systems-Level Architecting”, Appendix A in Maier, M. and Rechtin, E., *The Art of Systems Architecting*, CRC Press, 2000.

The INCOSE ASELCM Pattern

1. Schindel, W., and Dove, R., “Introduction to the ASELCM Pattern”, Proc. of INCOSE IS2016, Edinburg, UK, 2016
2. http://www.omgwiki.org/MBSE/lib/exe/fetch.php?media=mbse:patterns:mbse_patterns--public_private_and_hybrid_schindel_v1.2.3.pdf
3. http://www.omgwiki.org/MBSE/lib/exe/fetch.php?media=mbse:patterns:pbse_extension_of_mbse--methodology_summary_v1.5.5a.pdf
4. http://www.omgwiki.org/MBSE/lib/exe/fetch.php?media=mbse:patterns:pbse_tutorial_glrc_2016_v1.7.4.pdf

References: The Model Trust by Groups Phenomenon (cont'd)

Uncertainty and Its Communication:

1. Rhodes, D., German, E. (2017) "Model Centric Decision Making: Insights from an Expert Interview Study", MIT.
2. Weiss, C. (2008) "Communicating Uncertainty in Intelligence and Other Professions", *International J. of Intelligence and Counterintelligence*, Vol 21 No 1.
3. Sprenger, J. and Hartmann, S., (2019) *Bayesian Philosophy of Science*, Oxford U Press.
4. Kalman, Rudolf, (1960), 'A New Approach to Linear Filtering and Prediction Problems.' *Transactions of the ASME, Journal of Basic Engineering*, 82:34–45.

Learning and Diffusion of Methods:

1. Wade, J., Buenfil, J., and Collopy, P. (2020) "A Systems Engineering Approach for Artificial Intelligence: Inspired by the VLSI Revolution of Mead & Conway", to appear in *INCOSE INSIGHT*.
2. Conway, L, "Impact of the Mead-Conway innovations in VLSI chip design and implementation methodology: An overview by Lynn Conway", retrieve from <http://ai.eecs.umich.edu/people/conway/Impact/Impact%20of%20the%20Mead-Conway%20innovations.pdf>
3. National Research Council (1999). *Funding a Revolution: Government Support for Computing Research*. Washington, DC: The National Academies Press. <https://doi.org/10.17226/6323>.
4. McDermott, T., and Freeman, D. (2016) "Systems Thinking in the Systems Engineering Process: New Methods and Tools", in *Systems Thinking: Foundations, Uses, and Challenges*. Nova Publishing.
5. Kotter, J. (2014), *Accelerate: Building Strategic Agility for a Faster-Moving World*, Harvard Business Review Press, Boston.
6. Simoni, M., Andrijcic, E., Kline, W., and Bernal, A., (2016) "Helping Undergraduate Students of any Engineering Discipline Develop a Systems Perspective", *Proc. of 26th Annual INCOSE International Symposium*, Edinburg, Scotland, UK.
7. Schindel, W.D., S.N. Peffers, J.H. Hanson, J. Ahmed, and W.A. Kline (2011) "All Innovation is Innovation of Systems: An Integrated 3-D Model of Innovation Competencies," in *Proc. of American Society for Engineering Education Annual Conference and Exposition*, Vancouver, Canada.
8. Szajnfarder, Z., and Gralla, E.(2017) "Qualitative Methods for Engineering Systems: Why We Need Them and How to Use Them", *Systems Engineering*, 2017;20:497-511.
9. Schindel, W., "The Essential Tension" at https://www.omgwiki.org/MBSE/lib/exe/fetch.php?media=mbse:patterns:the_essential_tension_v1.3.2.pdf

References: Introduction Section

1. Friedenthal, S., et al (2015) 'A World In Motion: SE Vision 2025', INCOSE, San Diego, CA (US)
2. Watson, M. (2019) "Systems Engineering Principles and Hypotheses", *INCOSE INSIGHT*, May, 2019.
3. Rousseau, D., and Calvo-Amodio, J. (2019) "Systems Principles, Systems Science, and the Future of Systems Engineering" *INCOSE INSIGHT*, May, 2019.

Attachment I: More About the Phenomena

- The System Phenomenon
- The Value Selection Phenomenon
- The Model Trust by Groups Phenomenon

1. The System Phenomenon

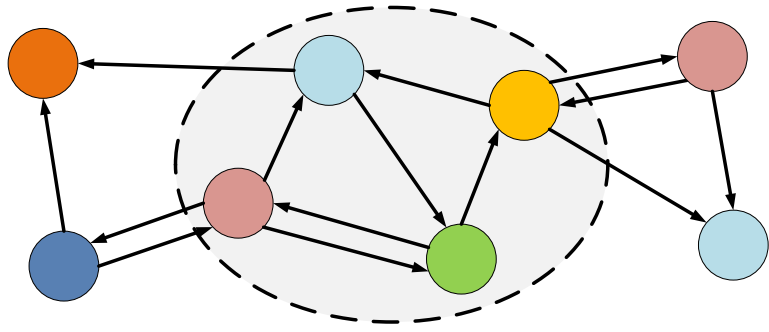

The System Phenomenon is about all interactions in all systems of all types. That includes engineered product systems as well as systems of engineering.

2. The Value Selection Phenomenon

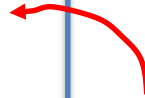

The Value Selection Phenomenon involves Selection and Performance interactions that are themselves special cases of the System Phenomenon.

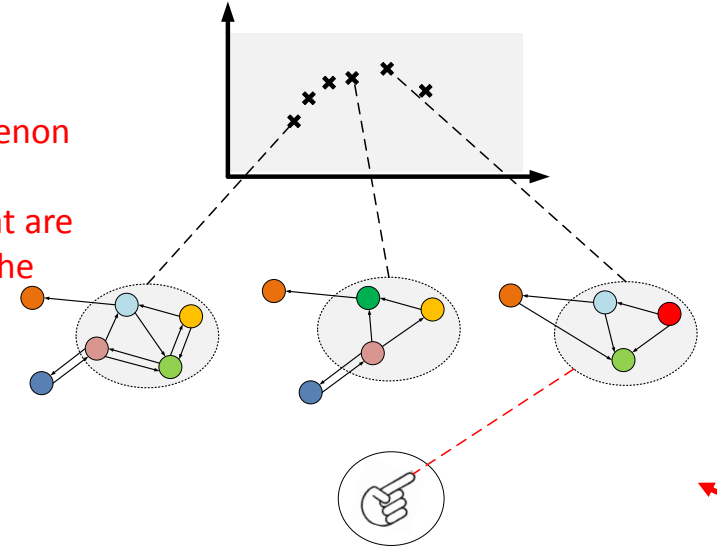

Three Foundational Systems Phenomena

The Model Trust Phenomenon involves discovering and learning models (or similar learning) of all types. So, the Value Selection Phenomenon is related, in that the Model Trust Phenomenon will “learn and trust” models of value selection, as well as other things.

3. The Model Trust by Groups Phenomenon

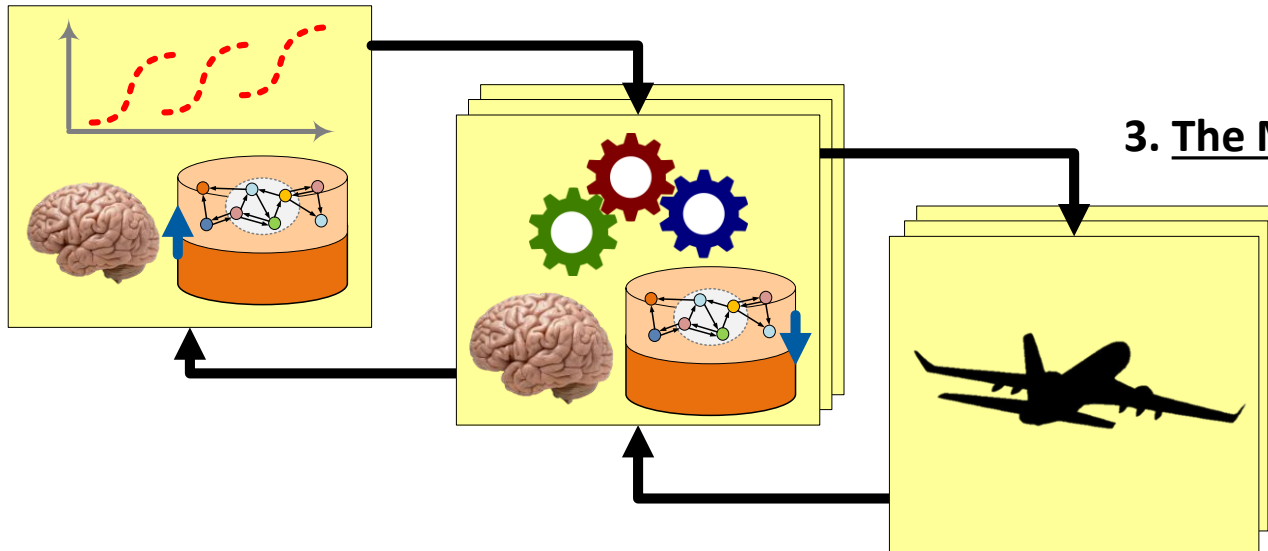

All 3 Phenomena occur prominently in a single integrated framework: The ASELCM System of Innovation Pattern

1. The System Phenomenon

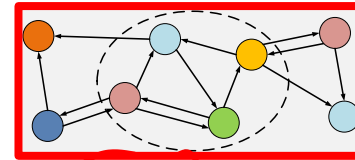

Emergent aspects of systems of regulation, professional education, and industry standards processes

Emergent aspects of engineering and life cycle management systems

Emergent aspects of engineered product systems

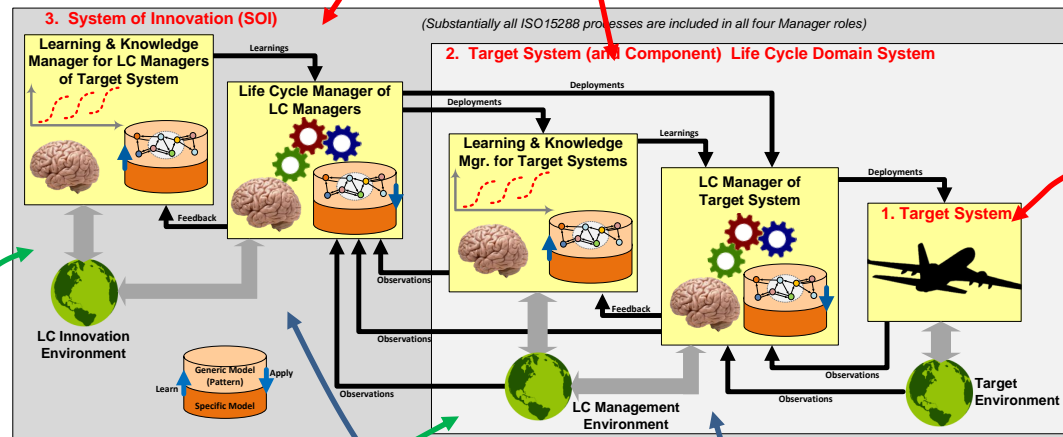

Trust in models of engineering processes, engineering tools, engineering methods, engineering staff, engineering facilities

Trust in models of engineered products, requirements, designs, product environments, competing products, adversaries

Selection of products, designs, requirements, designs, suppliers, market opportunities

Selection of engineering processes, facilities, staffing, project plans, methodologies

2. The Value Selection Phenomenon

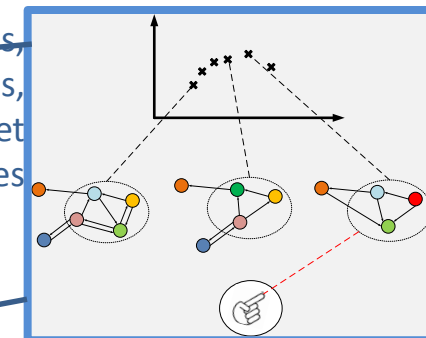

3. The Model Trust by Groups Phenomenon

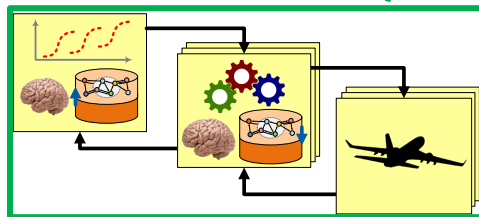

Attachment I: More About the Phenomena



- 1. The System Phenomenon:** Each of the traditional physical sciences is based on a specific physical phenomenon (mechanical, electrical, chemical, etc.) and related mathematical formulation of physical laws and first principles. What is the equivalent “hard science” phenomenon for systems, where is its mathematics, and what are the impacts on future SE practice? Are there also “soft” aspects?
- 2. The Value Selection Phenomenon:** Engineers know that value is essential to their practice, but its “soft” or subjective nature seems challenging to connect to hard science and engineering phenomena. What is the bridge effectively connecting these, where is the related mathematics, and what are the impacts on future SE practice?
- 3. The Model Trust by Groups Phenomenon:** The physical sciences accelerated progress in the last three centuries, as they demonstrated means for not just the discovery and representation of Nature’s patterns, but also the managed awarding of graduated shared trust in them. What is the scientific basis of such group learning, how is it related to machine learning, and how does it impact the future practice of SE?

What is the historical evidence for the Systems Phenomenon?

Historical Example 1: Chemistry

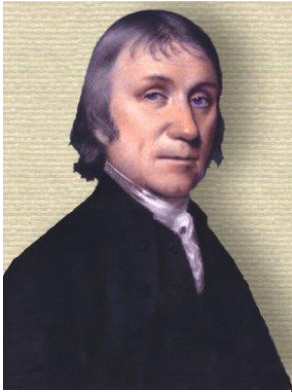

Priestley : Oxygen



Modern Chemist

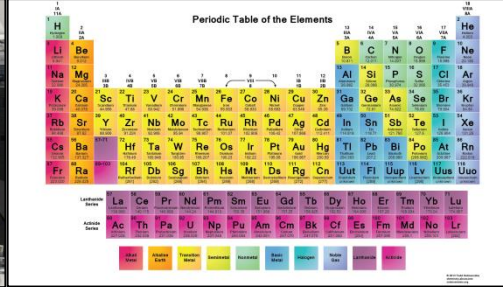

Periodic Table of the Elements

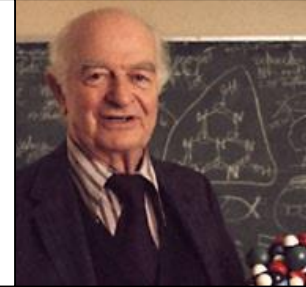

Pauling: Chemical Bond



Mendeleev: Periodic Table

- Chemists, and Chemical Engineers, justifiably consider their disciplines to be based on the “hard phenomena” of Chemistry:
 - Chemical Bonds, Chemical Reactions, Reaction Rates, Chemical Energy, Conservation of Mass and Energy.
- But, those chemical properties and behaviors are emergent consequences of interactions that occur between atoms’ orbiting electrons (or their quantum equivalents; also the rest of the atom). These lower-level interactions give rise to patterns that have their own higher-level properties and relationships, expressed as “hard science” laws.

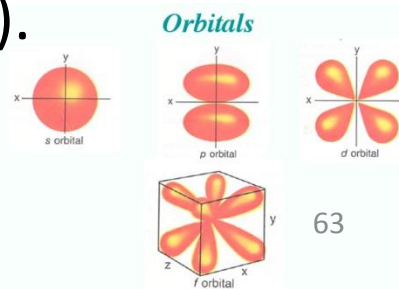
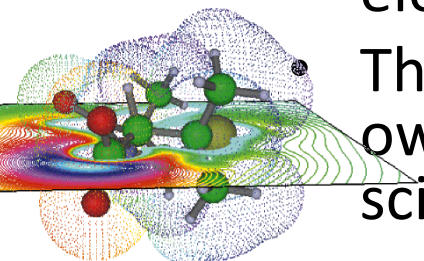

Chemistry, continued

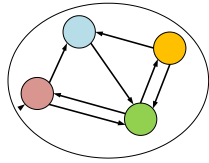

So . . .



- The “fundamental phenomena” of Chemistry, along with the scientifically-discovered / verified “fundamental laws / first principles” are in fact . . .
- Higher level emergent system patterns arising from interactions, and . . .
- Chemistry and Chemical Engineering study and apply those system patterns.

What is the historical evidence for the Systems Phenomenon?

Historical Example 2: The Gas Laws and Fluid Flow



Boyle



Daniel Bernoulli

$$PV = nRT$$

Pressure (P) points to P, Volume (V) points to V, Number of moles (n) points to n, Temperature (T) points to T, Gas constant (R) points to R.

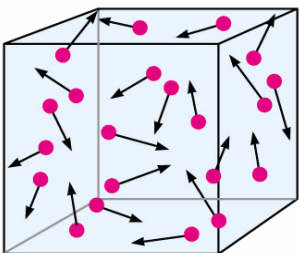
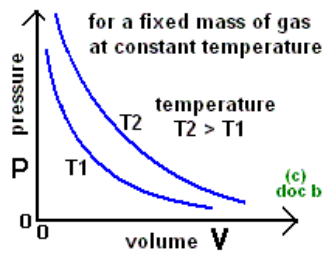

- The discovered and verified laws of gases and of compressible and incompressible fluid flow by Boyle, Avogadro, Charles, Gay-Lussac, Bernoulli, and others are rightly viewed as fundamental to science and engineering disciplines.
- But, all those gaseous properties and behaviors are emergent consequences of interactions that occur between atoms or molecules, and the containers they occupy, and the external thermal environment
- These lower level interactions give rise to patterns that have their own higher level properties and relationships, expressed as “hard sciences” laws.

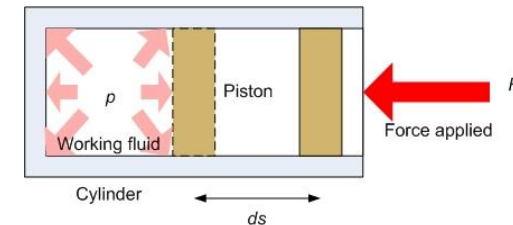
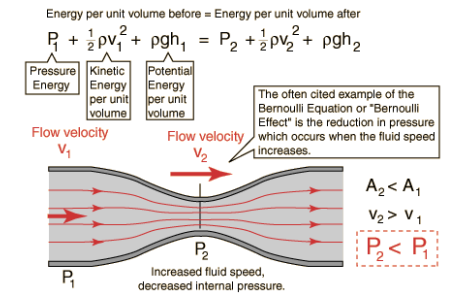

Boltzmann

Gas Laws, continued

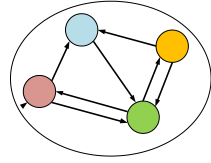

So . . .

- The “fundamental phenomena” of gases, along with the scientifically-discovered / verified “fundamental laws and first principles” are in fact . . .
- higher level emergent system patterns so that . . .
- Mechanical Engineers, Thermodynamicists, and Aerospace Engineers can study and apply those system patterns.

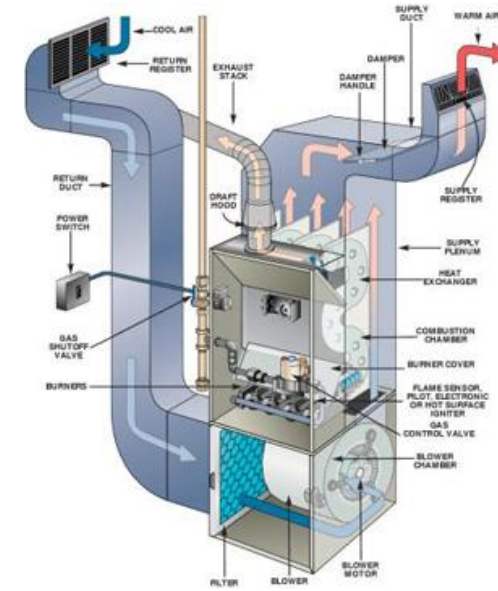

What is the historical evidence for the Systems Phenomenon?

More Recent Historical Examples

- Ground Vehicles
- Aircraft
- Marine Vessels
- Biological Regulatory Networks

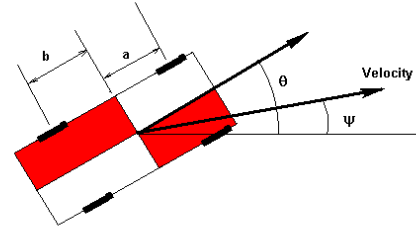

Dynamics of Road Vehicle

Denoting the angular velocity ω , the equations of motion are:

$$\frac{d\omega}{dt} = 2k \frac{(a-b)}{I} (\theta - \psi) - 2k \frac{(a^2 + b^2)}{VI} \omega$$

$$\frac{d\theta}{dt} = \omega$$

$$\frac{d\psi}{dt} = \frac{4k}{MV} (\theta - \psi) + 2k \frac{(b-a)}{MV^2} \omega$$

NASA Glenn Research Center

Forces in a Climb

climb angle = c

L = Lift
 D = Drag
 W = Weight
 F = Thrust

m = aircraft mass
 a = acceleration

Equations:

$$L \cos(c) + F \sin(c) - D \sin(c) - W = m a_{\text{Vertical}}$$

$$F \cos(c) - L \sin(c) - D \cos(c) = m a_{\text{Horizontal}}$$

Definition of Excess Thrust: $F - D = F_{\text{ex}}$

$$L \cos(c) + F_{\text{ex}} \sin(c) - W = m a_{\text{Vertical}}$$

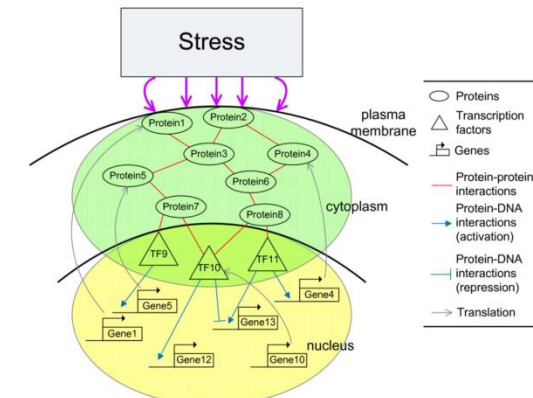
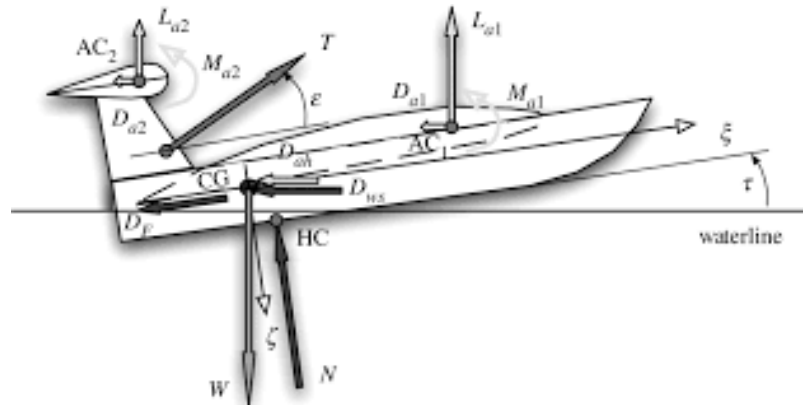
$$F_{\text{ex}} \cos(c) - L \sin(c) = m a_{\text{Horizontal}}$$

Future Examples

- Utility and other distribution networks
- Biological organisms and ecologies
- Market systems and economies
- Health care delivery, other societal services
- Systems of conflict
- Agile innovation

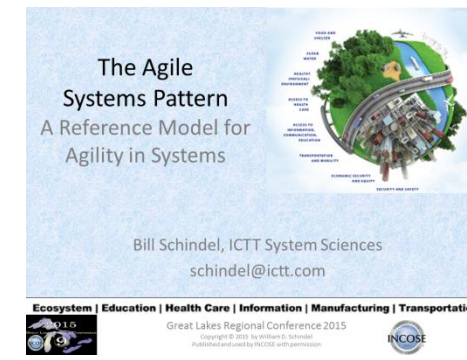
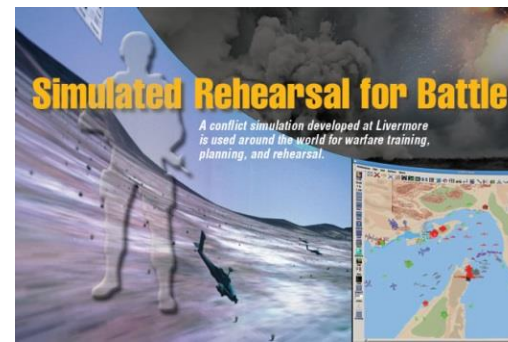
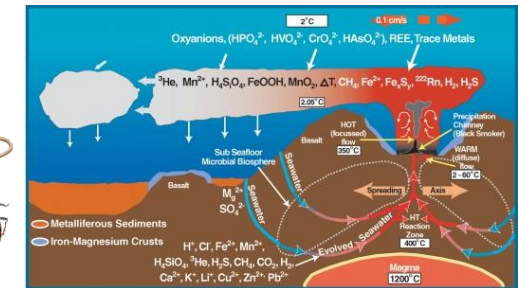
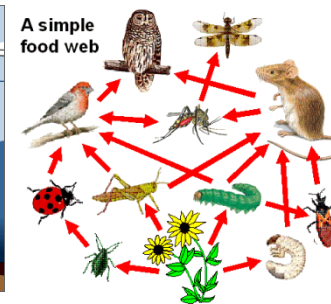
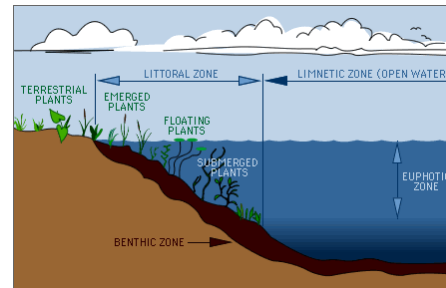

What support for the unpredictable richness of the domain hierarchy emerging from the Systems Phenomenon?

Two Nobel Laureates Weigh In

1. P.W. Anderson's landmark paper: Anderson, P. W., "More Is Different: Broken Symmetry and the Nature of the Hierarchical Structure of Science", *Science* 04 Aug 1972: Vol. 177, Issue 4047, pp. 393-396 DOI: 10.1126/science.
2. Laughlin, R., *A Different Universe: Reinventing Physics from the Bottom Down*, Basic Books, 2006

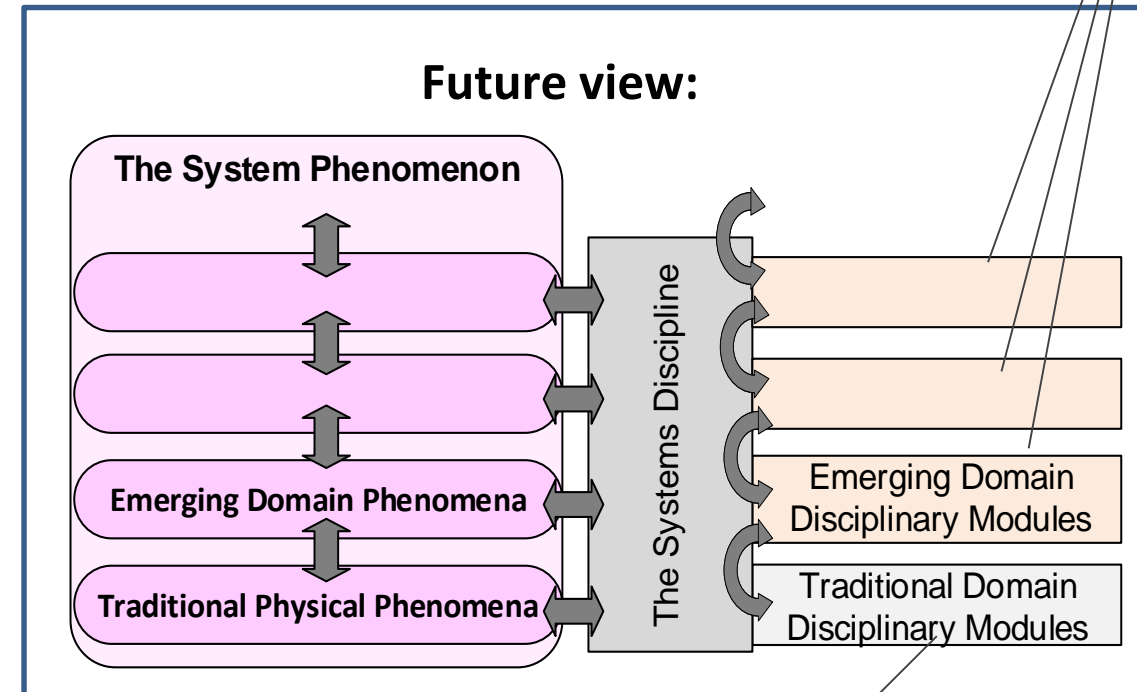

Mathematics for the System Phenomenon: Building on Hamilton's Principle

- The System Phenomenon is a more general pattern than the mathematics of the original Hamilton's Principle that is associated with that model:
 - Reviewing the conceptual framework of the System Phenomenon should convince you that it is much more general in scope than the setting for the original formulation of Hamilton's Principle (continuous, conservative phenomena).
 - Sure enough, more generalized mathematical treatments were discovered later, and in one important case earlier.
 - It was remarkable (to Max Planck and many others) that the Principle of Least Action was already sufficient to provide the mathematics from which can be derived the fundamental equations of all the major branches of physics...but...
- We are interested in engineering of more general types of systems, and...
- The more general Interaction model framework of the Systems Phenomenon is further supported by all the following later mathematical constructions and their discoverers . . .

The System Phenomenon, Building on Hamilton's Principle



- **Hamilton's Principle**: Was already strong enough to generate all the fundamental phenomena of physics, from Newton through Feynman
- **Noether's Theorem**: Deeper insight into the connection of Hamilton's principle to Symmetry and Conservation Laws. Both symmetries and patterns have fixed (invariant) and variable parts.
- **D'Lambert's Principle**: Older than Hamilton, but wider in scope than Hamilton's Principle, adding non-holonomic constraints, dissipative systems
- **Bernhard Riemann**: Embedded Manifold spaces further generalize representation of complex dynamics.

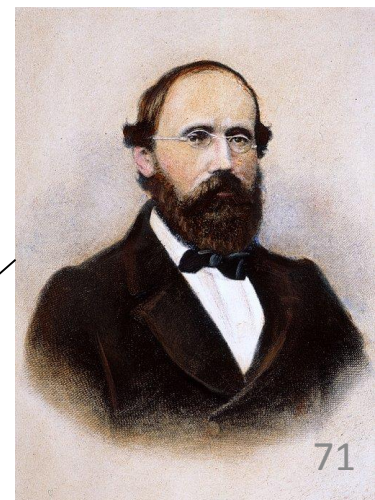

The System Phenomenon, Building on Hamilton's Principle

- **Cornelius Lanczos**: Master elucidator of Analytical Mechanics
- **Prigogine, Sieniutycz, Farkas**: Irreversible and large scale thermodynamic systems
- **JE Marsden, A Bloch, Marston Morse**: Non-Holonomic Control Systems, Discrete Mechanics; Symbolic Dynamics, Discrete Hamilton's Principle; Discrete Noether's Theorem
- **Ed Fredkin, Charles Bennett, Tomas Toffoli, Richard Feynman**: Information Systems and Automata

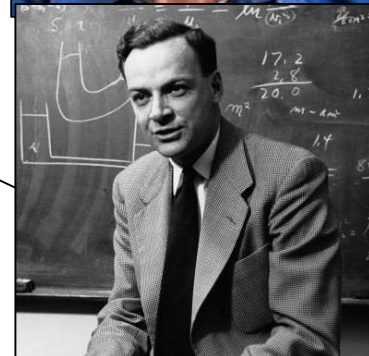
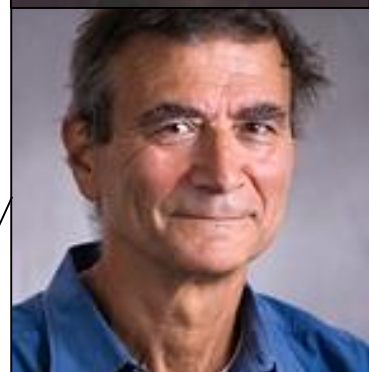
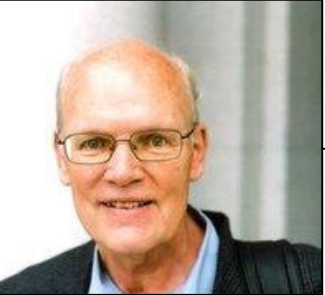
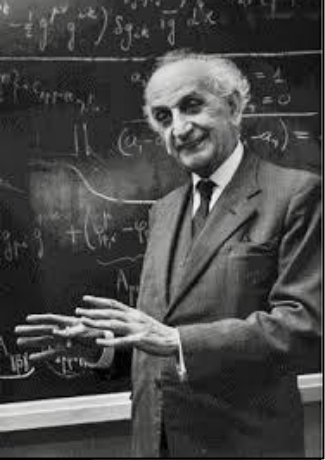

Phenomena occur in Context of Interactions:

Interactions occur between system components through the exchange of force, energy, material, or information, leading to changes of state.

Examples: Combustion, Melting, Corrosion

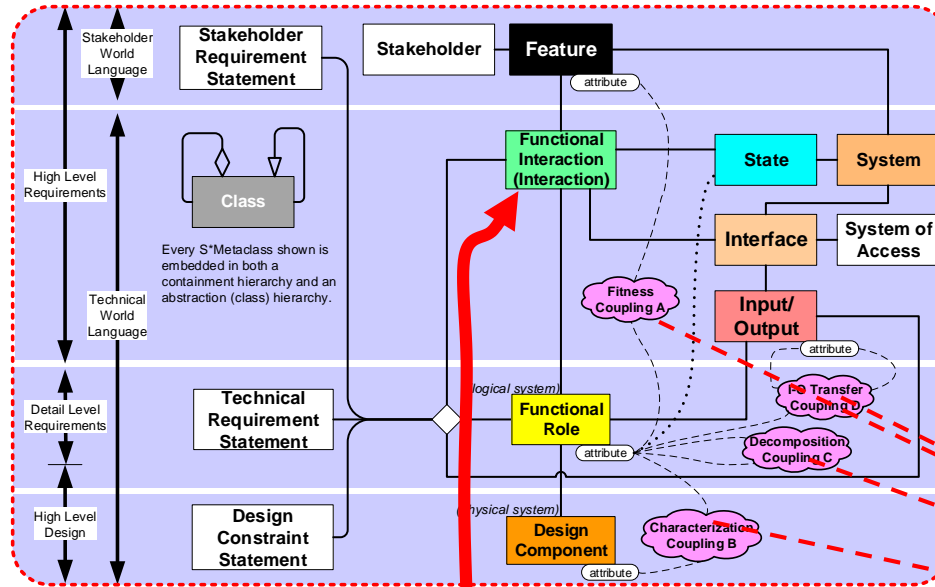
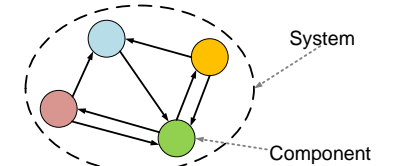

S*Metamodel informal summary pedagogical diagram
(formal S*Metamodel includes additional details.)

Attribute Coupling

System Model

Inherently linguistic side (semantics, ontologies)

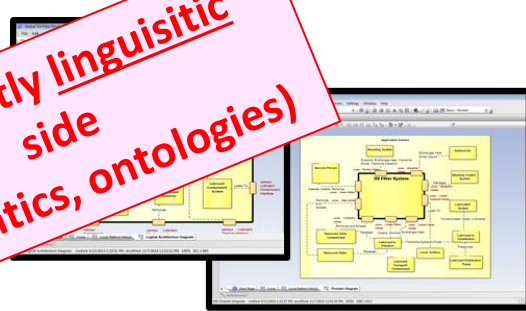

MBSE Model

Interactions: Key to systems models

PIRT

Phenomena Identification and Ranking Table (PIRT): Key to computational modeling

Computational Model

FEA Model

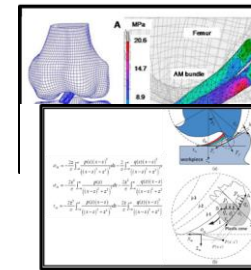

Physics-Based PDE Model

OD

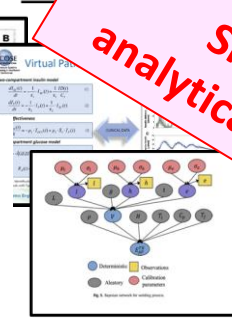

Data-Driven Bayesian Network Model

Inherently Quantitative Side (math, analytical mechanics)

2. Attributes (variables, parameters) take on values (continuous or discrete) that quantify.

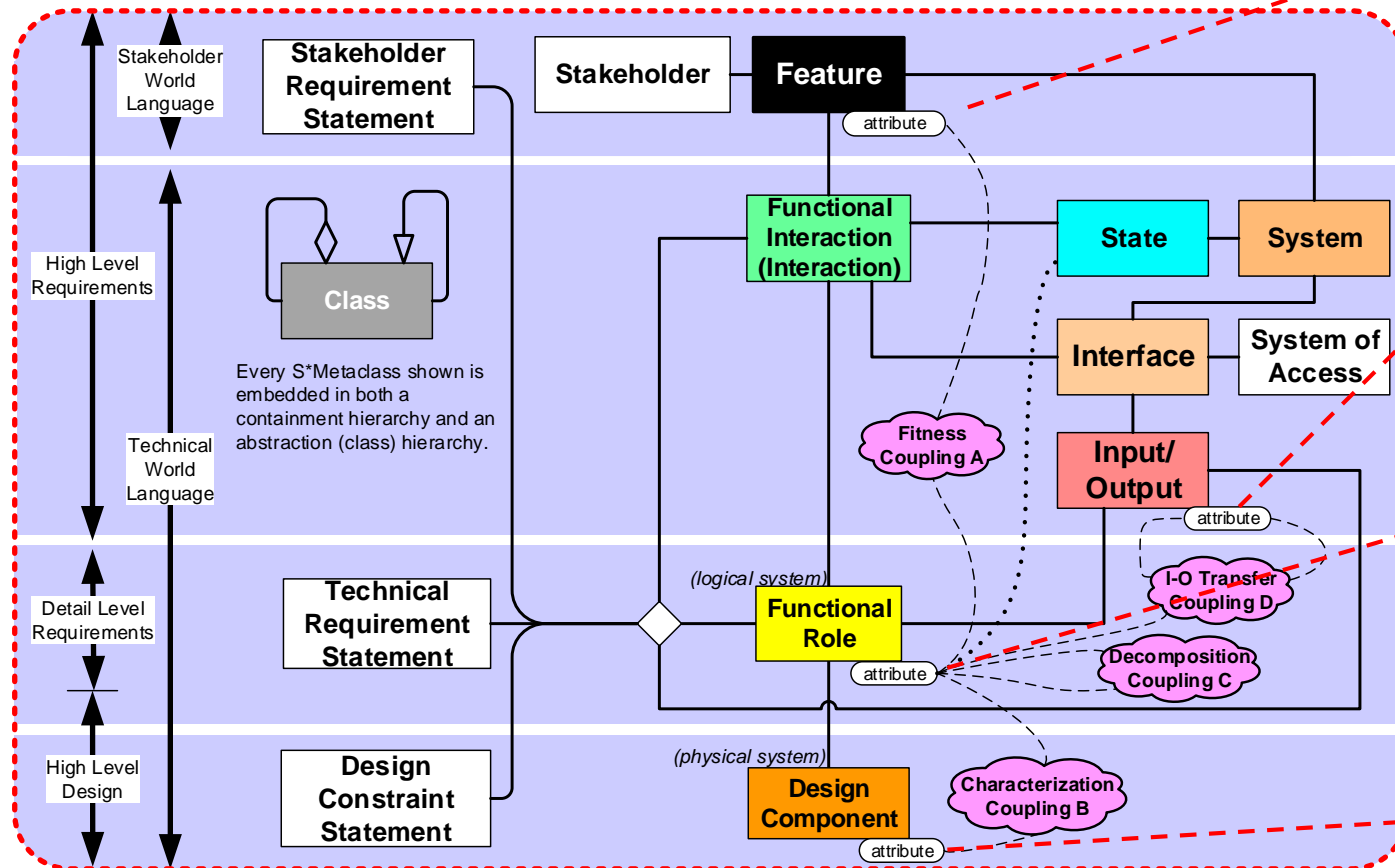

S*Metamodel informal summary pedagogical diagram
(formal S*Metamodel includes additional details.)

1. Feature Attributes quantify Measures of Effectiveness, and related stakeholder value attributes. Examples: Fuel Economy; Production Yield.
2. Input-Output Attributes quantify (often dynamical) input-output quantities. Examples: Thrust; Raw Material.
3. Role Attributes: Quantify dynamic state variables or parametric measures of performance. Examples: Tensile Strength; Melting Point; Temperature.
4. Design Component Attributes: Quantify the identity of a component to which has been allocated performance of a Functional Role. Examples: Part Number; Material Type

3. Attribute Couplings (dependencies, equations, laws) relate/constrain the values (continuous or discrete) of coupled attributes.

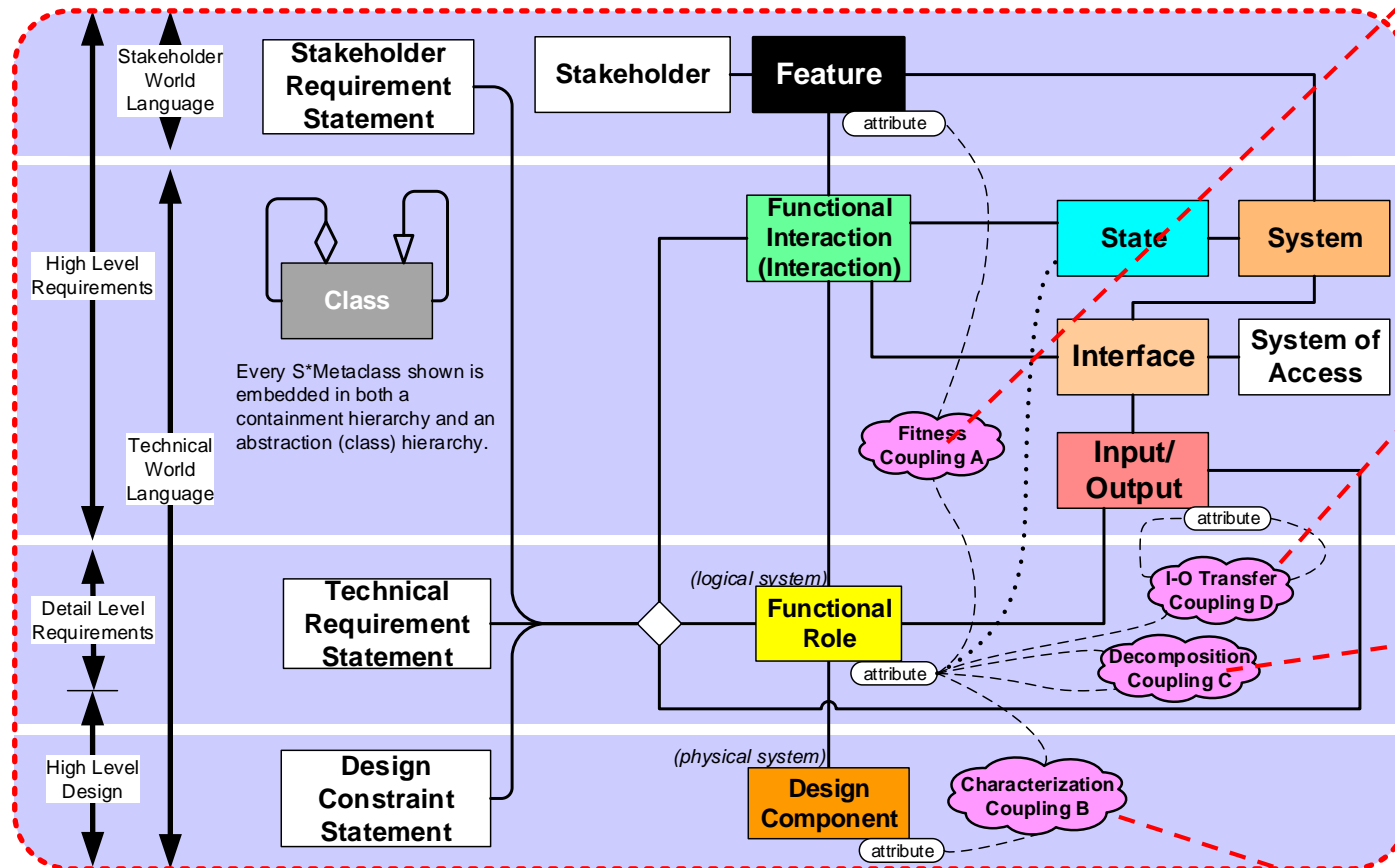

S*Metamodel informal summary pedagogical diagram
(formal S*Metamodel includes additional details.)

1. **Fitness Couplings:** Express how technical performance and stakeholder value are related—in effect, the utility or perceived value of technical performance. Examples: Market share as function of performance, cost, reliability, cost.
2. **I-O Transfer Couplings:** Express how output, is related to input, as function of state or other parameters. Examples: Part quality as function of raw material feedstock and process parameters.
3. **Decomposition Couplings:** Express how higher level system state depends on lower level subsystem parameters. Examples: Engine efficiency as function of compressor stage parameters.
4. **Characterization Couplings:** Express how behavior of a component is related to the identity of the component. Examples: Tensile Strength as a function of Chemical Identity.

Attachment I: More About the Phenomena

1. **The System Phenomenon**: Each of the traditional physical sciences is based on a specific physical phenomenon (mechanical, electrical, chemical, etc.) and related mathematical formulation of physical laws and first principles. What is the equivalent “hard science” phenomenon for systems, where is its mathematics, and what are the impacts on future SE practice? Are there also “soft” aspects?
2. **The Value Selection Phenomenon**: Engineers know that value is essential to their practice, but its “soft” or subjective nature seems challenging to connect to hard science and engineering phenomena. What is the bridge effectively connecting these, where is the related mathematics, and what are the impacts on future SE practice?
3. **The Model Trust by Groups Phenomenon**: The physical sciences accelerated progress in the last three centuries, as they demonstrated means for not just the discovery and representation of Nature’s patterns, but also the managed awarding of graduated shared trust in them. What is the scientific basis of such group learning, how is it related to machine learning, and how does it impact the future practice of SE?

Representing Performance Value “Tradespace”

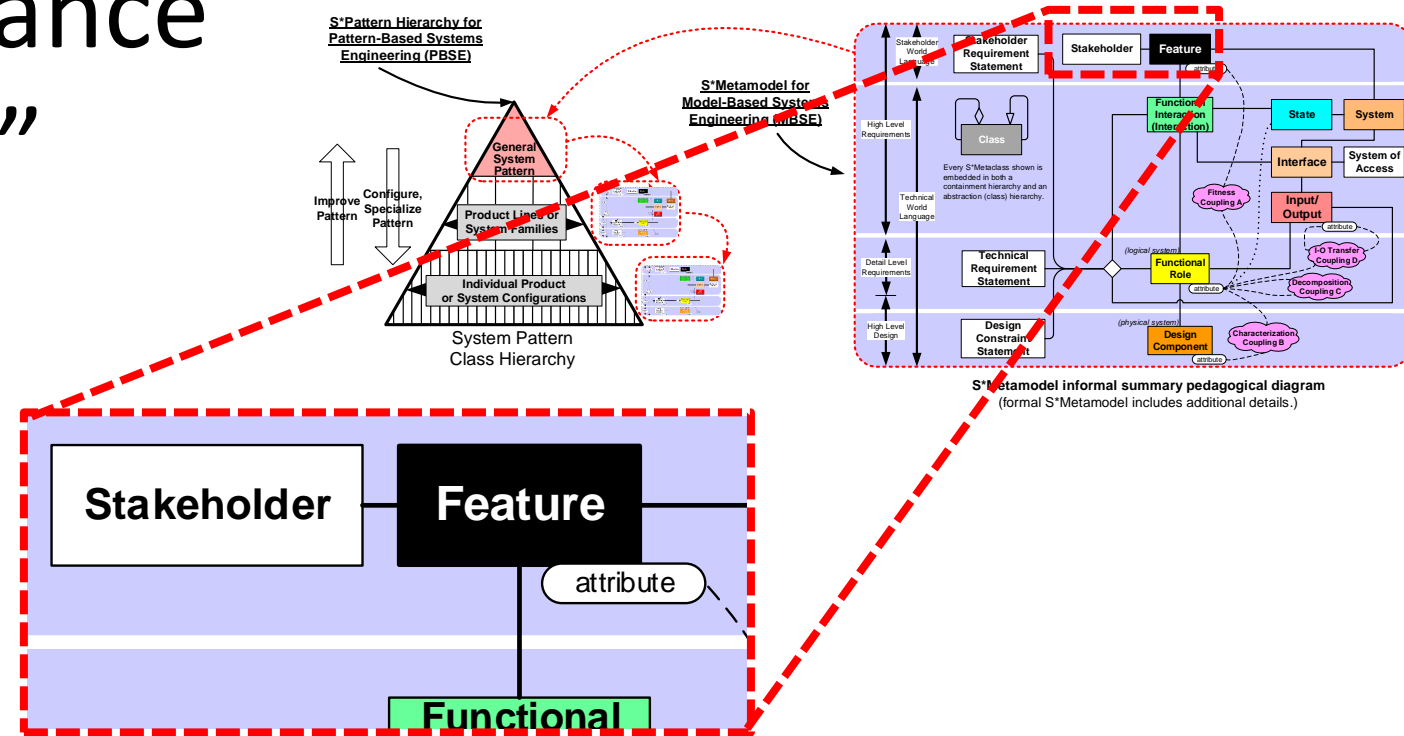

- Each S* Pattern—such as those arising at progressively higher-level System Phenomenon levels--formalizes a sharable domain-specific language (DSL), including the “value space”, characteristic of that domain.

Representing Performance Value “Tradespace”

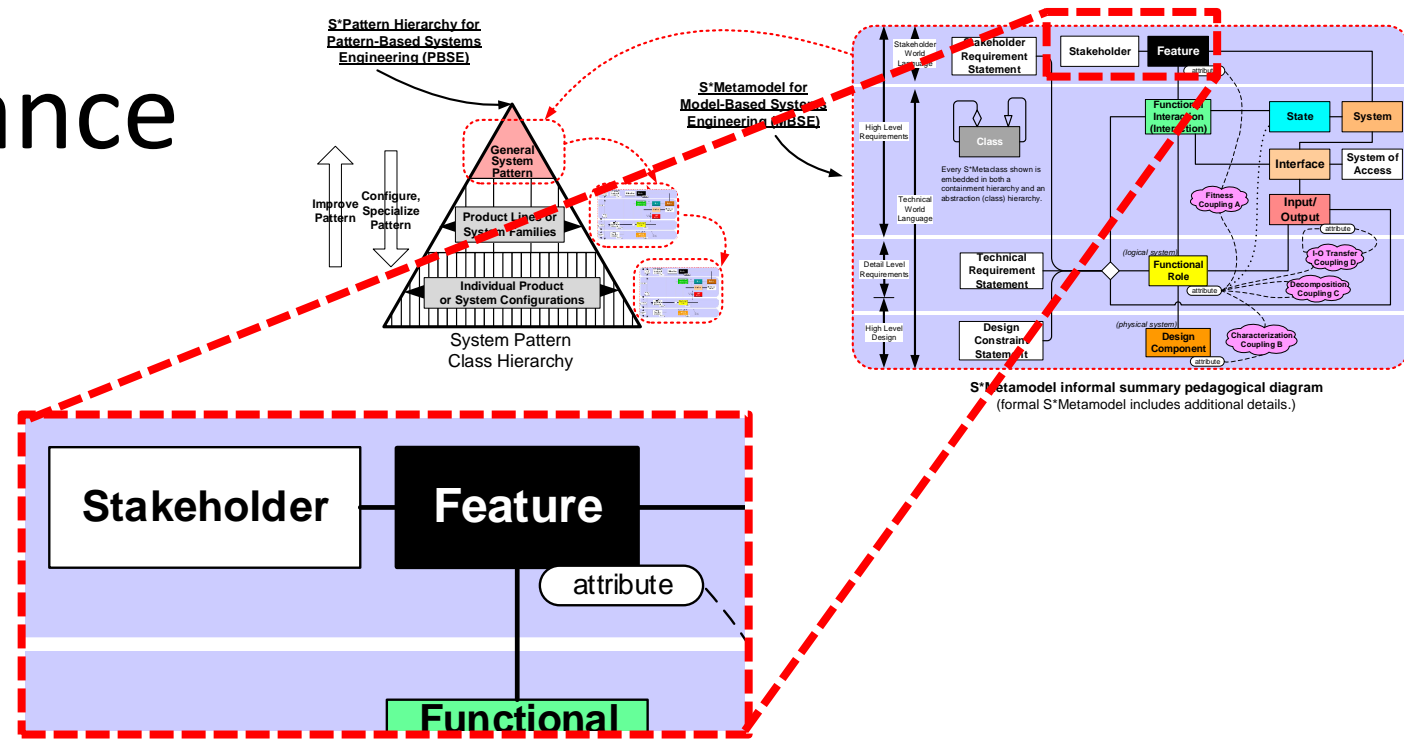

This simplifies use of the same consistent value space--and for more than might be guessed:

1. Optimization, frontiers, decision-making, trades, selection;
2. Understanding selection influencers of different people(s), organizations, and Nature;
3. “E” of FMEA—effects of failures, penalties, only things that can be at risk, risk management, project management;
4. Partitioning of platform configuration space for market covering variant minimization;
5. Steering the sequence of adaptive work and investment increments, product trajectories. 78

Explicit management of innovation direction trajectories, during and across product life cycle projects

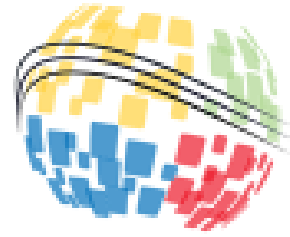

27th annual **INCOSE**
International Symposium
Adelaide, Australia
July 15 - 20, 2017



Innovation, Risk, and Agility, Viewed as Optimal Control & Estimation

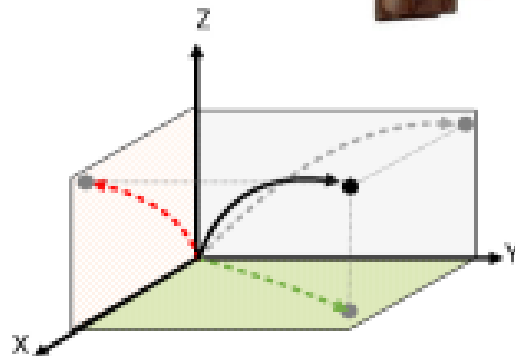
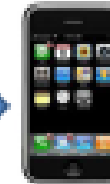

Bill Schindel
ICTT System Sciences
schindel@icct.com

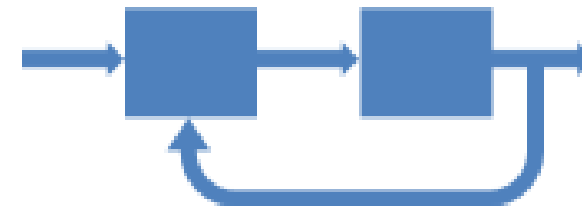

MBSE, PBSE: A Phase Change in SE Emphasis

Process & Procedure

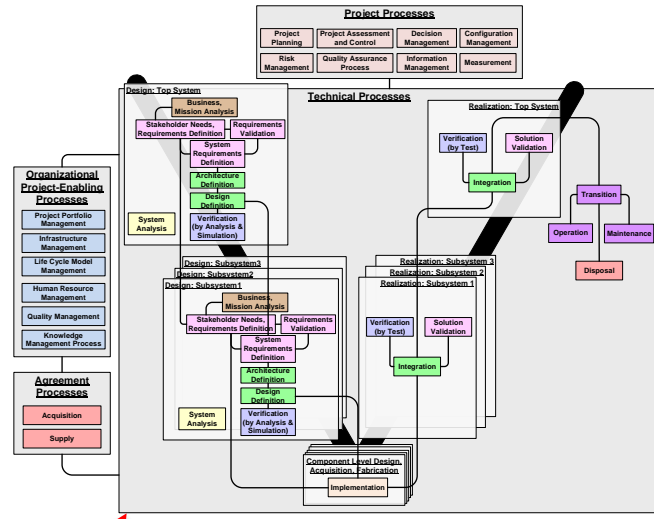

Traditional Systems Engineering Emphasizes **Process**

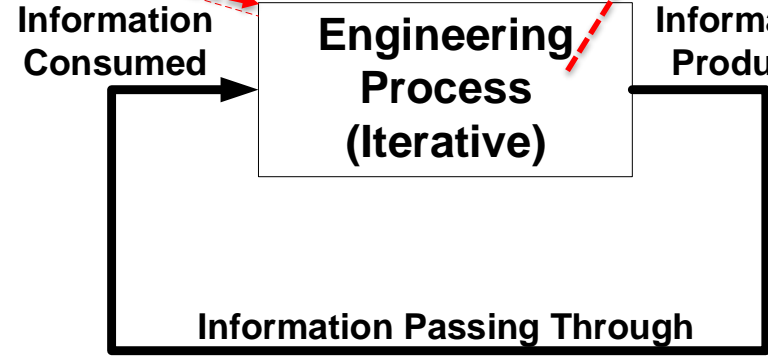

MBSE Increases Relative Emphasis on **Information**

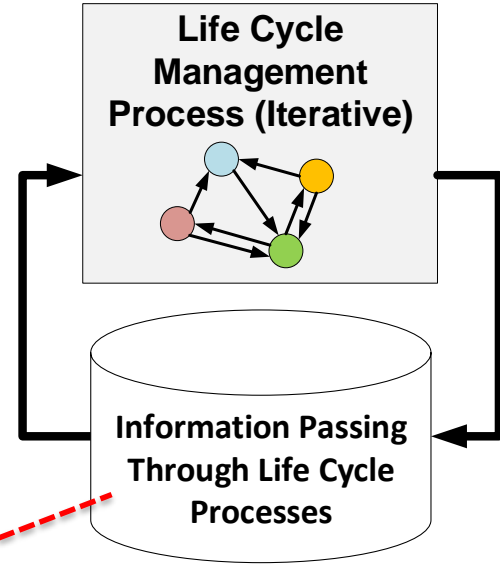
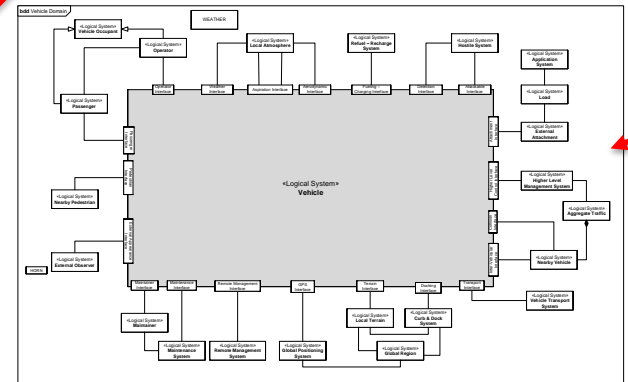

Models

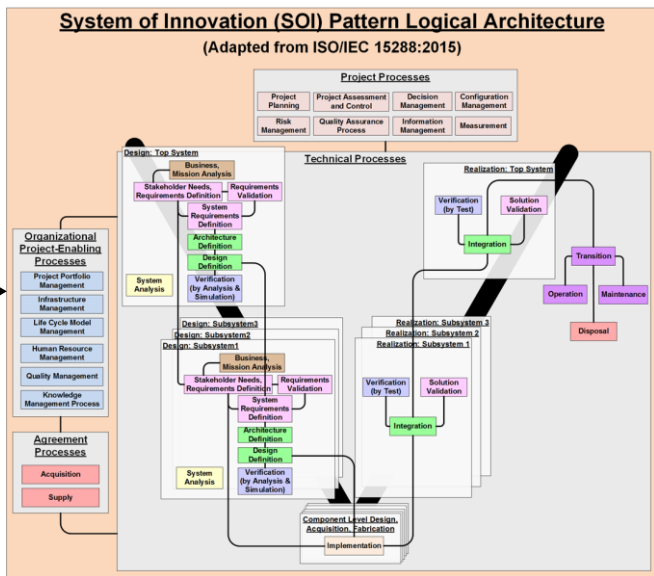

System Life Cycle Trajectories in S*Space, and S*Subspaces

Summary of S*Metamodel Defines System Configuration Space

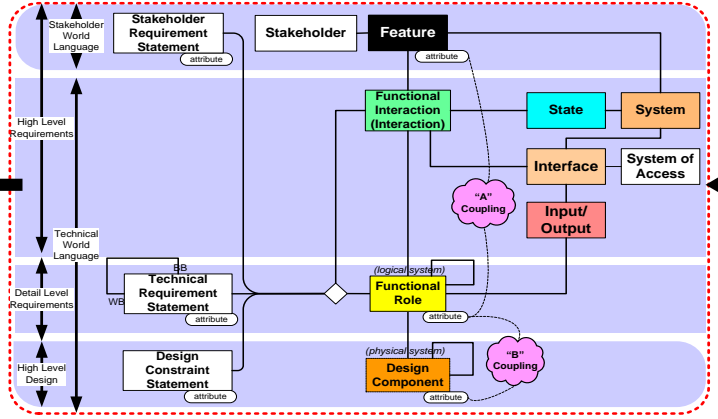

System Configuration Space (S*Space)

Stakeholder Feature Subspace

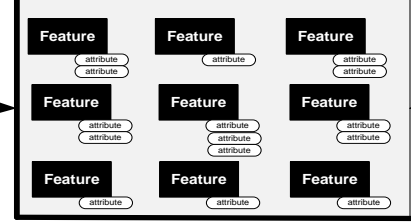

Sub-subspaces

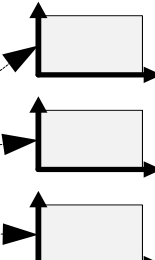

Technical Behavior Subspace

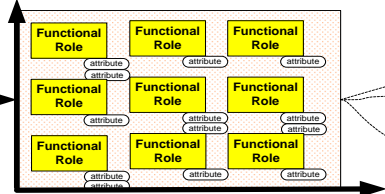

Continuous Subspace

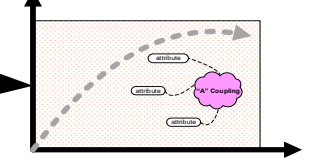

Physical Architecture Subspace

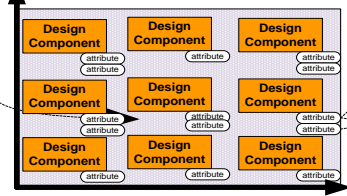

Discrete Subspace

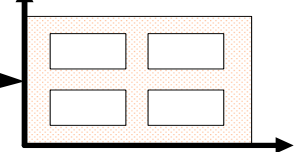

Sub-subspaces

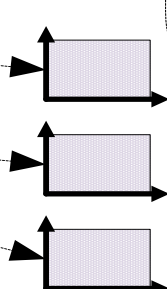

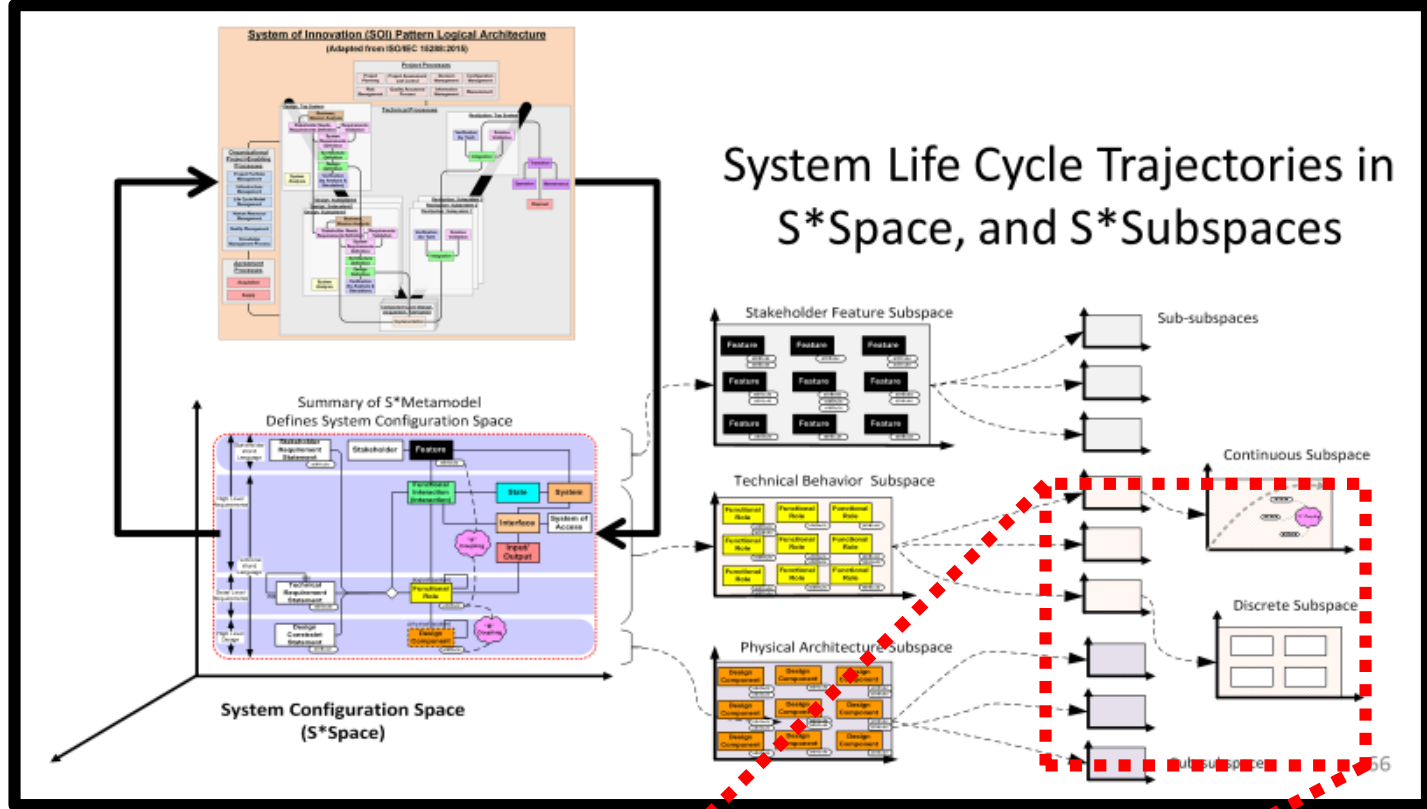

System Life Cycle Trajectories in S*Space, and S*Subspaces

• “Incremental gains” in performance usually occur here

• “Paradigm shifts” in architecture usually occur here.
 • This is also where new linguistic structures / ontologies appear.

Maps vs. Itineraries -- SE Information vs. SE Process



Itinerary \neq Map!
(What am I doing?)



Map!
(Where am I?)

When they eventually did emerge, maps represented a newer idea of the nature of "where".

- The SE Process consumes and produces information.
- But, SE historically emphasizes process over information. (Evidence: Ink & effort spent describing standard process versus standard information.)
- Ever happen?-- Junior staff completes all the process steps, all the boxes are checked, but outcome is not okay.
- Recent discoveries about ancient navigators: Maps vs. Itineraries.
- The geometrization of Algebra, Function Space, and Embedded Manifolds (Descartes, Hilbert, Riemann)
- Knowing where you "really" are, not just what "step" you are doing.
- Knowing where you are "really" going, not just what "step" you are doing next.
- Distance metrics, inner products, projections in system configuration S^* Space.

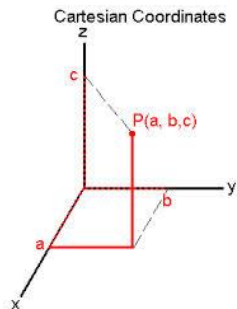

Rene Descartes
1596 - 1650

Geometrization of Algebra

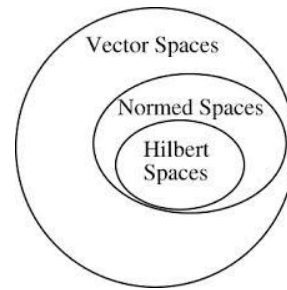

David Hilbert
1862 - 1943

Geometrization of Function Space

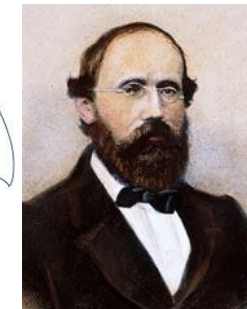
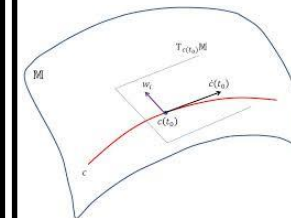

Bernhard Riemann
1826 - 1866

Dynamics on Embedded Manifolds⁸³

What Optimal Control and Estimation Theory Tells Us

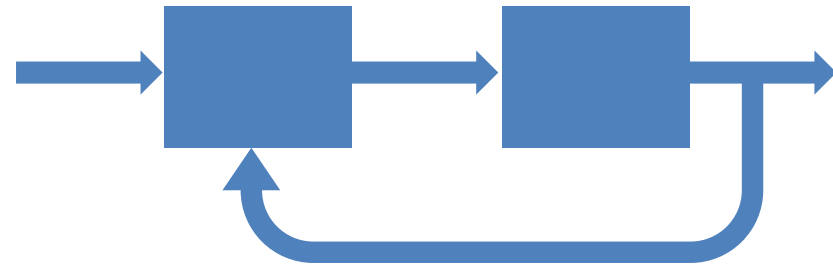

- 50+ years of successfully applied math, used in other domains:
 - Norbert Wiener (time series, fire control systems, feedback control, cybernetics), Rudolph Kalman (filtering theory, optimal Bayesian estimation), Lev Pontryagin (optimal control, maximum principle), Richard Bellman (dynamic programming), others.
 - Applied with great success to fire control systems, inertial navigation systems, all manner of subsequent domain-specific feedback control systems.
- Model-Based Filtering Theory and Optimal Estimation in Noisy Environment:
 - Estimation, from noisy observations, of current state of a modeled system that is partly driven by random processes, optimized as to uncertainty.
 - Control of a managed system's trajectory, optimized as to time of travel, destination reached, stochastic outcomes.

Is it Plausible to Apply Optimal Control to the Innovation Process?

Aspect of Common Theoretical Framework	Application to a Vehicle Guidance System	Application to a System of Innovation
Overall domain system	Propelled airborne vehicle guidance to moving airborne target	Development of new system configuration for a system of interest
The controlled system	Airborne Pursuit Vehicle	The development process
Control system	Flight control system and pilot sometimes	Development management & decision-making process
Other actors	Target, atmosphere	Stakeholders, operating environment of system of interest, suppliers
State space in which controlled performance occurs	Vehicle position in 3-D geometric space	Configuration space of system of interest, including its features, technical requirements, and physical architecture
Driving processes	Target dynamics, pursuit thrust, flight control surface movements	Stakeholder interest, supply chain
Random aspects of driving processes	Buffeting winds	Stakeholder preferences, competition, technologies
Observation process model	Radar tracking of moving target, sensor characterization	Status reporting, market feedback, development status report process
Random disturbances of observation processes	Sensor errors	Inaccuracies or unknowables in development status; sampling errors
Environmental Conditions	Target maneuvers; atmospheric effects	Market or other environmental conditions;
Control input	Flight control surface orientation	Management direction; resources
Objective function to optimize	Time to target	Time to market; Competitive Response Time; Innovated System Performance; Innovation Risk vs. Reward
Dynamical model	Ballistic Flight, Atmospheric Effects, Thrust	Coupled development processes
Outcome risk	Risk of missing airborne target	Risk of innovation outcomes across stakeholders

Attachment I: More About the Phenomena

1. **The System Phenomenon**: Each of the traditional physical sciences is based on a specific physical phenomenon (mechanical, electrical, chemical, etc.) and related mathematical formulation of physical laws and first principles. What is the equivalent “hard science” phenomenon for systems, where is its mathematics, and what are the impacts on future SE practice? Are there also “soft” aspects?
2. **The Value Selection Phenomenon**: Engineers know that value is essential to their practice, but its “soft” or subjective nature seems challenging to connect to hard science and engineering phenomena. What is the bridge effectively connecting these, where is the related mathematics, and what are the impacts on future SE practice?
3. **The Model Trust by Groups Phenomenon**: The physical sciences accelerated progress in the last three centuries, as they demonstrated means for not just the discovery and representation of Nature’s patterns, but also the managed awarding of graduated shared trust in them. What is the scientific basis of such group learning, how is it related to machine learning, and how does it impact the future practice of SE?

Physics-Based Model

- Predicts the external behavior of the System of Interest, visible externally to the external actors with which it interacts.
- Models internal physical interactions of the System of Interest, and how they combine to cause/explain externally visible behavior.
- Model has both external predictive value and phenomena-based internal-to-external explanatory value.
- Overall model may have high dimensionality.

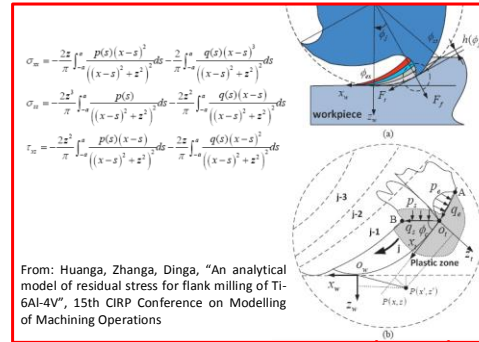

Data Driven Model

- Predicts the external behavior of the System of Interest, visible to the external actors with which it interacts.
- Model intermediate quantities may not correspond to internal or external physical parameters, but combine to adequately predict external behavior, fitting it to compressed relationships.
- Model has external predictive value, but not internal explanatory value.
- Overall model may have reduced dimensionality.

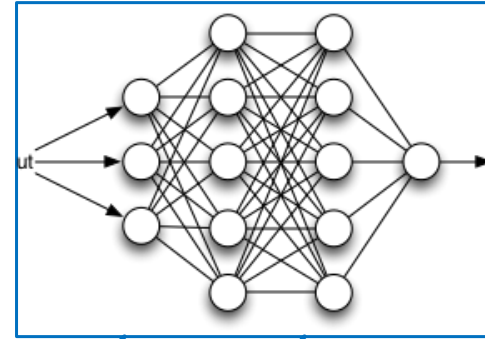

- Physical scientists and phenomena models from their disciplines can apply here.
- The hard sciences physical laws, and how they can be used to explain the externally visible behavior of the system of interest.

- Data scientists and their math/IT tools can apply here (data mining, pattern extraction, cognitive AI tooling).
- Tools and methods for discovery / extraction of recurring patterns of external behavior.

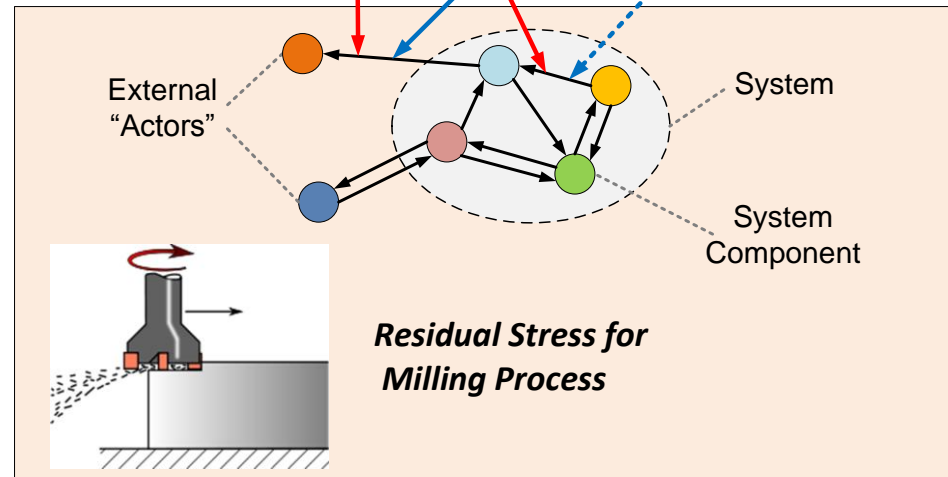

Real Target System Being Modeled

Model Trust by Groups Phenomenon: More aspects

The Model Trust by Groups Phenomenon involves additional critical aspects beyond just uncertainty quantification (UQ) for a computational model:

1. Additional roles involving intermediary roles in model interpretation and otherwise: Rhodes, D., German, E., "Model Centric Decision Making: Insights from an Expert Interview Study", MIT, 25 Oct., 2017.
2. Communication of uncertainty to non-technical decision-makers: Weiss, C., "Communicating Uncertainty in Intelligence and Other Professions", *International J. of Intelligence and Counterintelligence*, Vol 21 No 1, 2008.
3. Generalized Model Credibility Assessment Frameworks: Kaizer, J., "Credibility Assessment Frameworks: Personal Views", May, 2018.
<https://cstools.asme.org/csconnect/FileUpload.cfm?View=yes&ID=54674>
4. Hysteresis models of individual and group learning: See "The Essential Tension" at https://www.omgwiki.org/MBSE/lib/exe/fetch.php?media=mbse:patterns:the_essential_tension_v1.3.2.pdf

More Historical Evidence as to Bayesian Aspects: Kalman-Bucy Filter

- R.E. Kalman's (1960) contribution of the optimal linear Bayesian state estimator for mixing prior and new information from a noisy environment:
 - Widely deployed by the engineering community
 - Prominent example: Apollo navigation to the Moon
 - Many aerospace and other applications
 - Illustrates a Bayesian approach to ongoing mixing of what we already know with new data, resulting in optimal estimates of state, plus expression of degree of uncertainty of that combined knowledge.
 - Illustrates the difference between (a human or automated agent's) uncertainty of state versus (frequentist) probability distribution description of random processes.
 - Schindel, W. (1972). "The Kalman-Bucy Filter: Theory and Applications", Rose-Hulman Institute of Technology, 1972., Retrieve from https://scholar.rose-hulman.edu/cgi/viewcontent.cgi?article=1000&context=math_grad_theses
 - More recently see: Bayesian Neural Networks (BNN's)

Phase Change #1 Evidence: Efficacy of Phenomena-Based STEM Disciplines



In a matter of a 300 years . . .

- the accelerating emergence of Science, Technology, Engineering, and Mathematics (STEM) . . .
- has lifted the possibility, nature, quality, and length of life for a large portion of humanity . . .
- while dramatically increasing human future potential.
- By 20th Century close, strong STEM capability was recognized as a critical ingredient to individual and collective prosperity.

The length of human life has been dramatically extended:

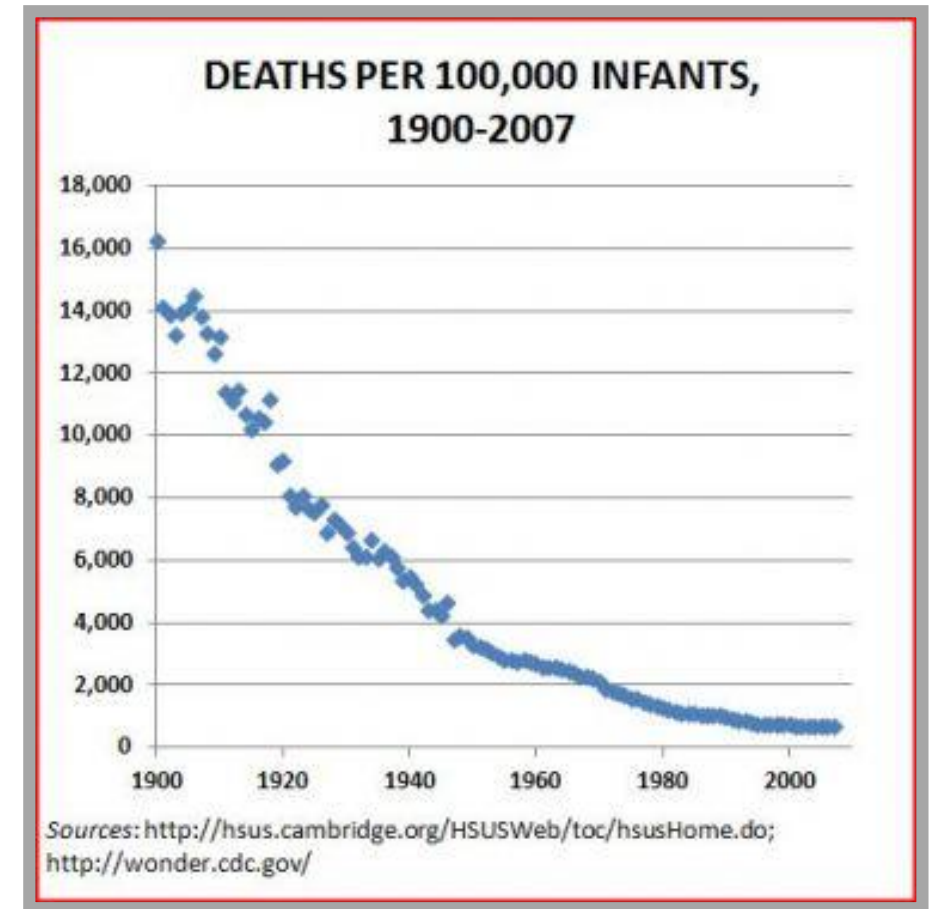
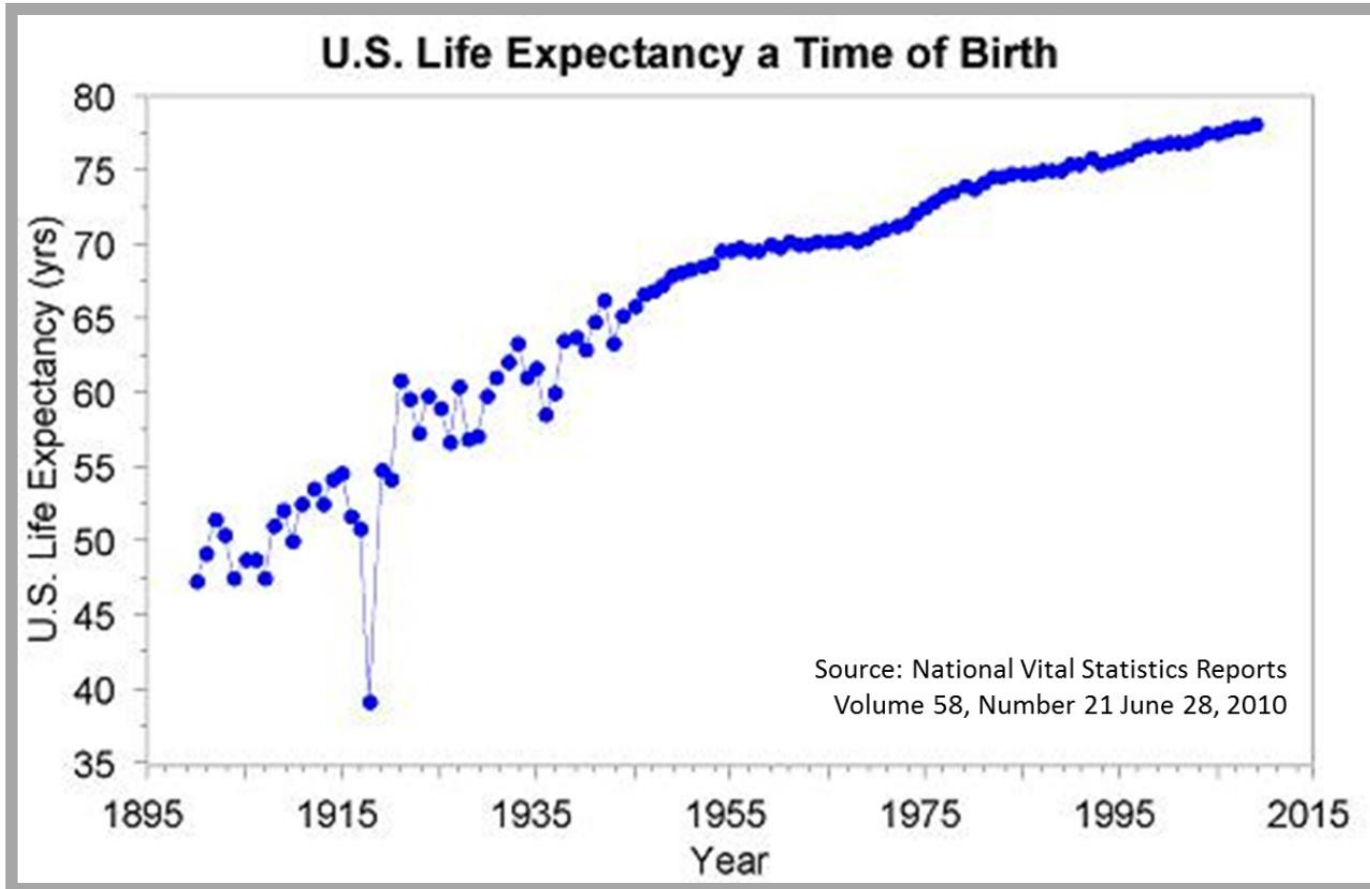

Simply feeding ourselves consumes less labor and time:

Food Expenditures Share of Disposable Personal Income 1929 - 2009

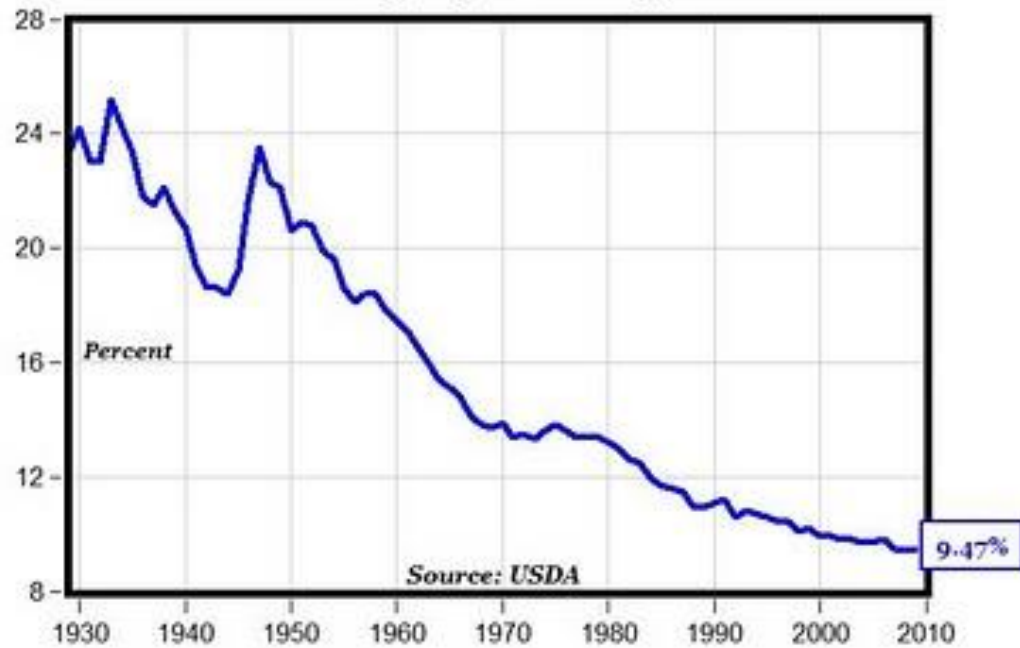

GDP per Capita of the US 1870 to 2011

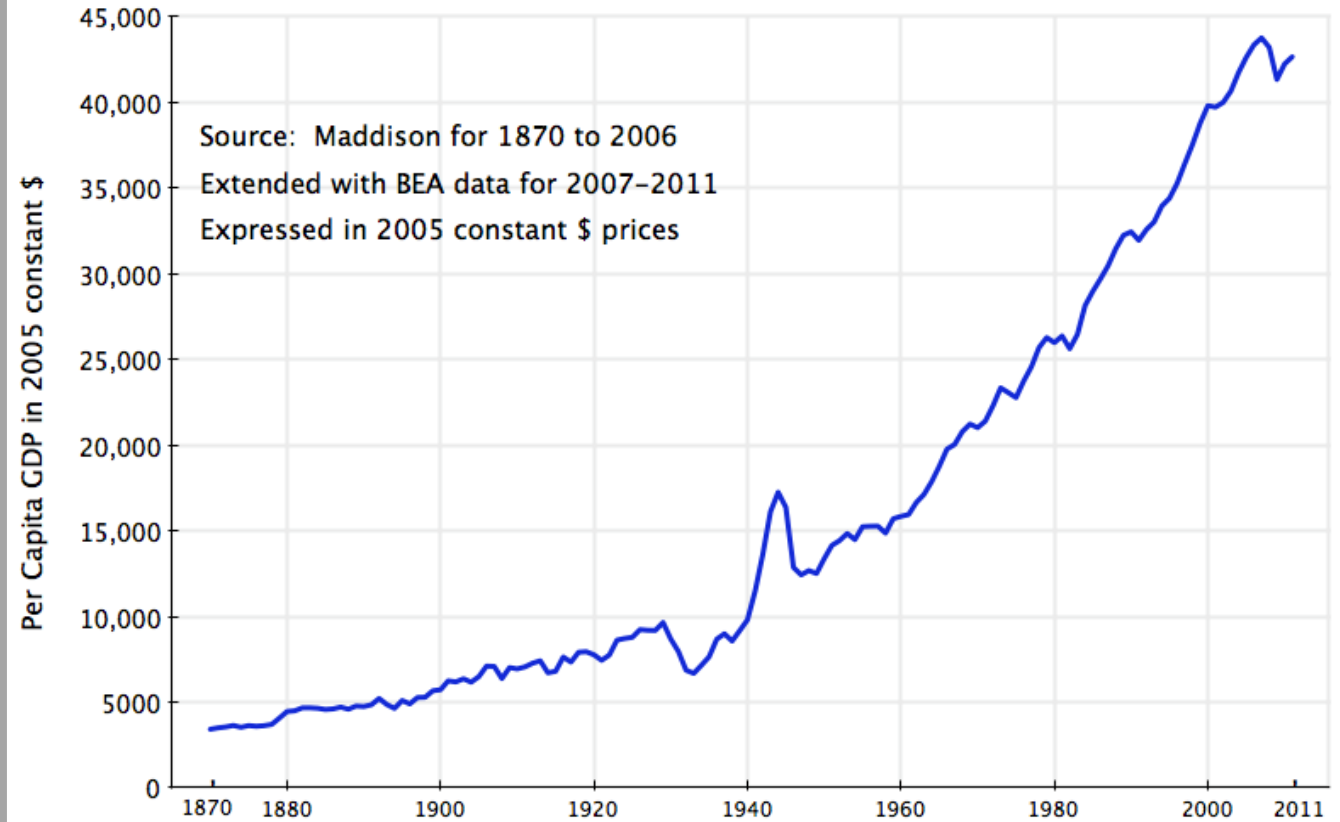

The range of individual human travel has vastly extended:

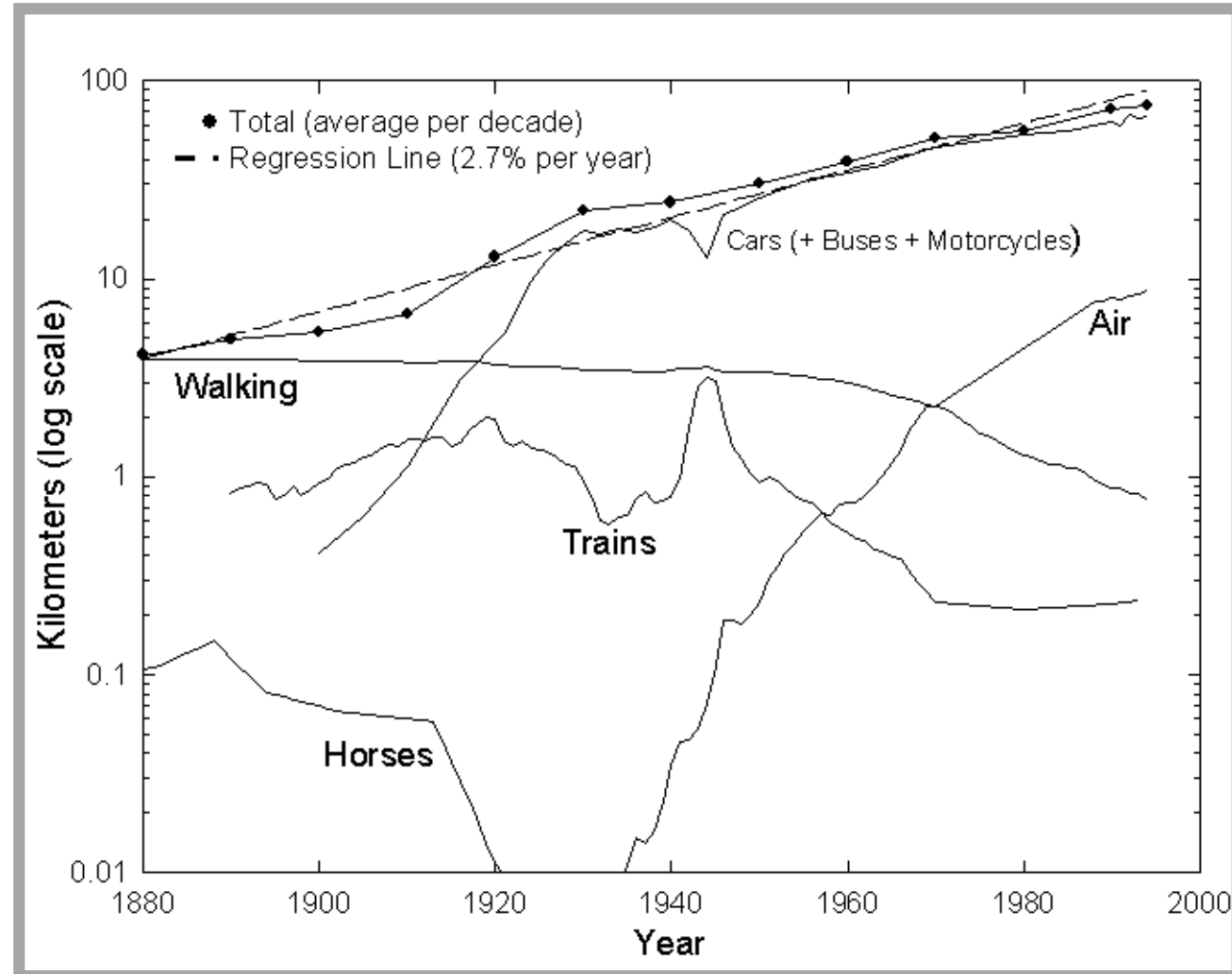

US passenger travel per capita per day by all modes.

Sources of data: Grubler , US Bureau of the Census , US Department of Transportation

Challenges Have Likewise Emerged



- In recent decades, the human-populated world has become vastly more interconnected, complex, and challenging . . .
- Offering both expanding opportunities and threats.
- From the smallest known constituents of matter and life, to the largest-scale complexities of networks, economies, the natural environment, and living systems . . .
- Understanding and harnessing the possibilities have become even more important than before.

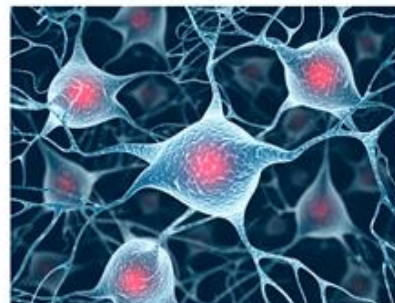

Systems progress has come with challenging side effects:

Motor Vehicle Related Traffic Fatalities (1899-1962)

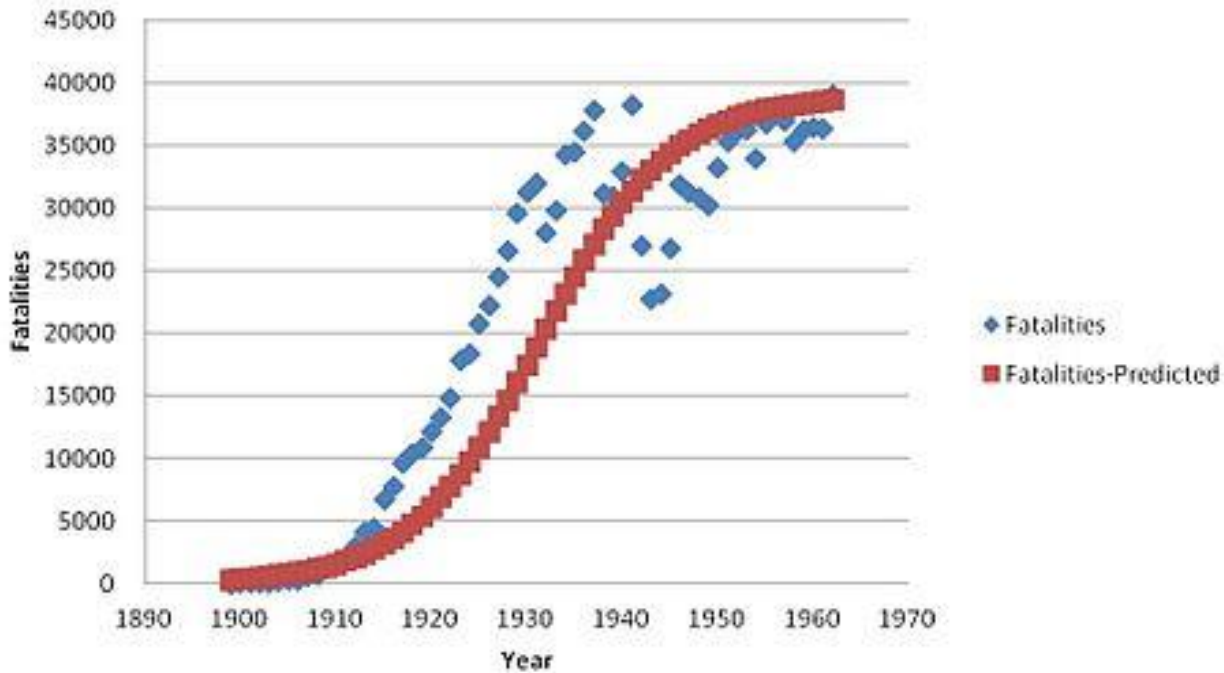

NHTSA and FHWA data

Global Fossil Carbon Emissions

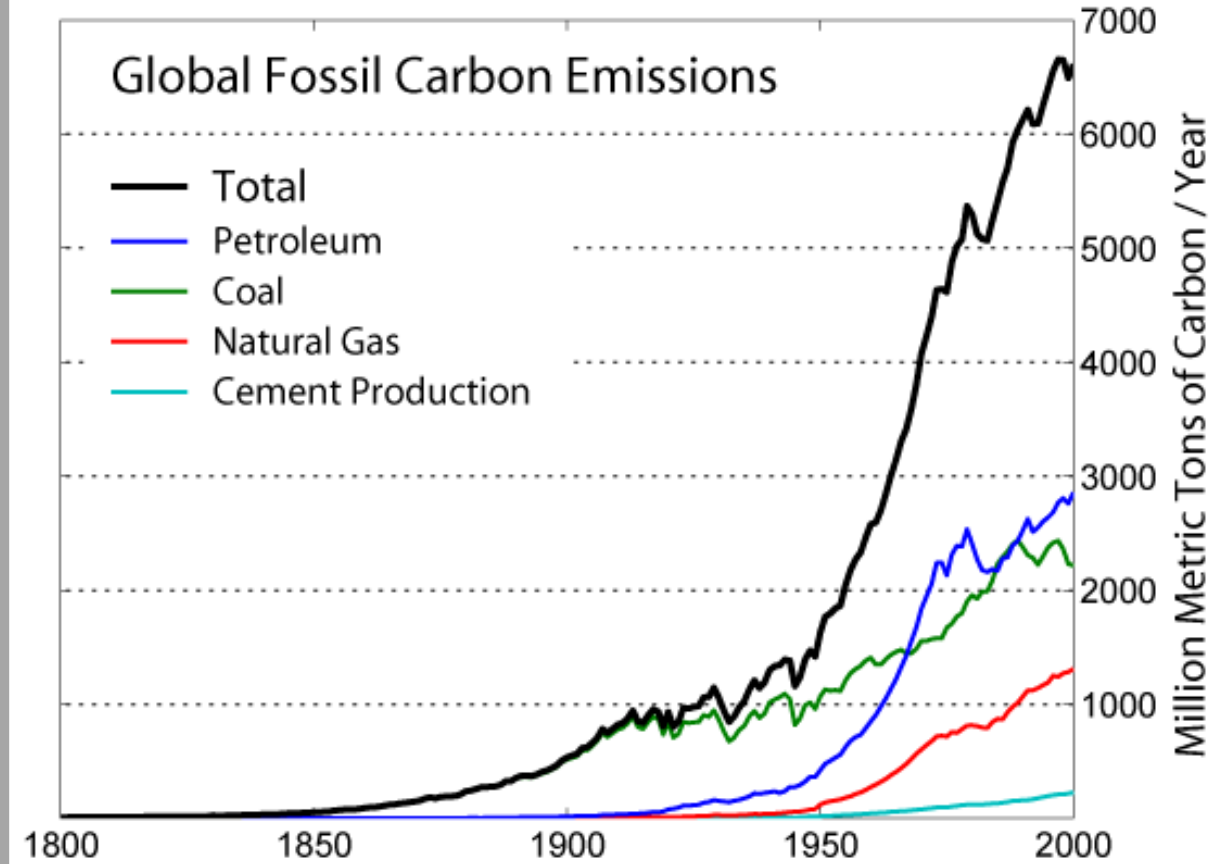

In Trends: A Compendium of Data on Global Change. [Carbon Dioxide Information Analysis Center](#), Oak Ridge National Laboratory, [United States Department of Energy](#), Oak Ridge, Tenn., U.S.A

Not all human progress has been STEM-driven

- For example, the spread of market capitalism can be argued to have also lifted human life.
- Nevertheless STEM has been a major contributor:

Impact	Notable STEM Drivers (samples)
Increased life expectancy	Life sciences, nutritional science
Reduced infant mortality	
Reduced food production cost	Agronomy, herbicides, fertilizers, mechanization
Increased GDP per capita	Mechanized production, mechanized distribution
Increased range of travel	Vehicular, civil, and aerospace engineering
Increased traffic fatalities	Vehicular engineering, civil engineering
Increased carbon emissions	Vehicular engineering; mechanized production

1. The System Phenomenon

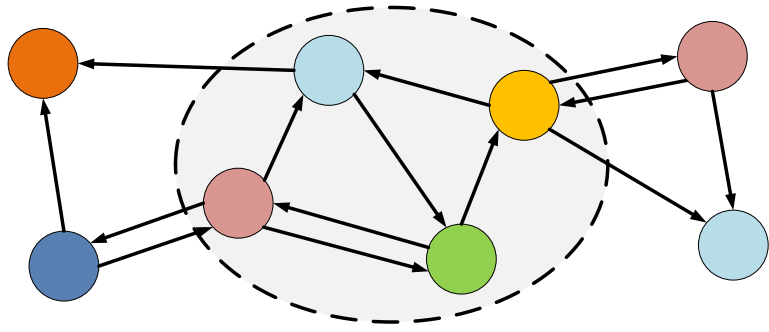

The System Phenomenon is about all interactions in all systems of all types. That includes engineered product systems as well as systems of engineering.

2. The Value Selection Phenomenon



The Value Selection Phenomenon involves Selection and Performance interactions that are themselves special cases of the System Phenomenon.

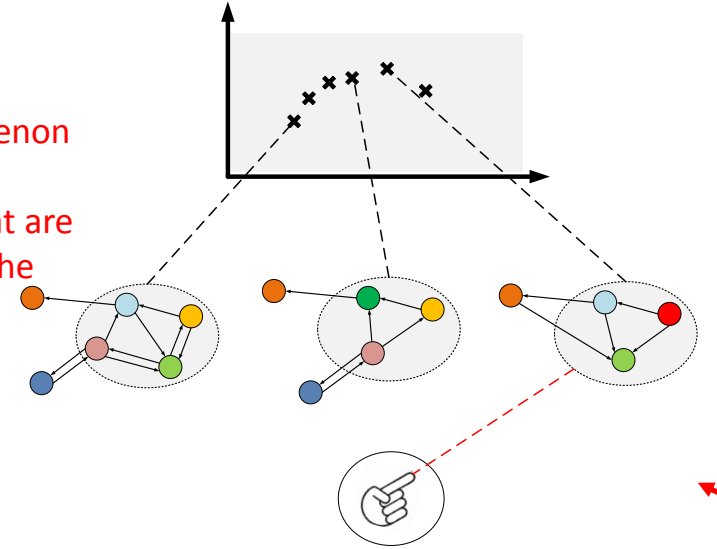

Three Foundational Systems Phenomena

The Model Trust Phenomenon involves discovering and learning models (or similar learning) of all types. So, the Value Selection Phenomenon is related, in that the Model Trust Phenomenon will “learn and trust” models of value selection, as well as other things.

3. The Model Trust by Groups Phenomenon

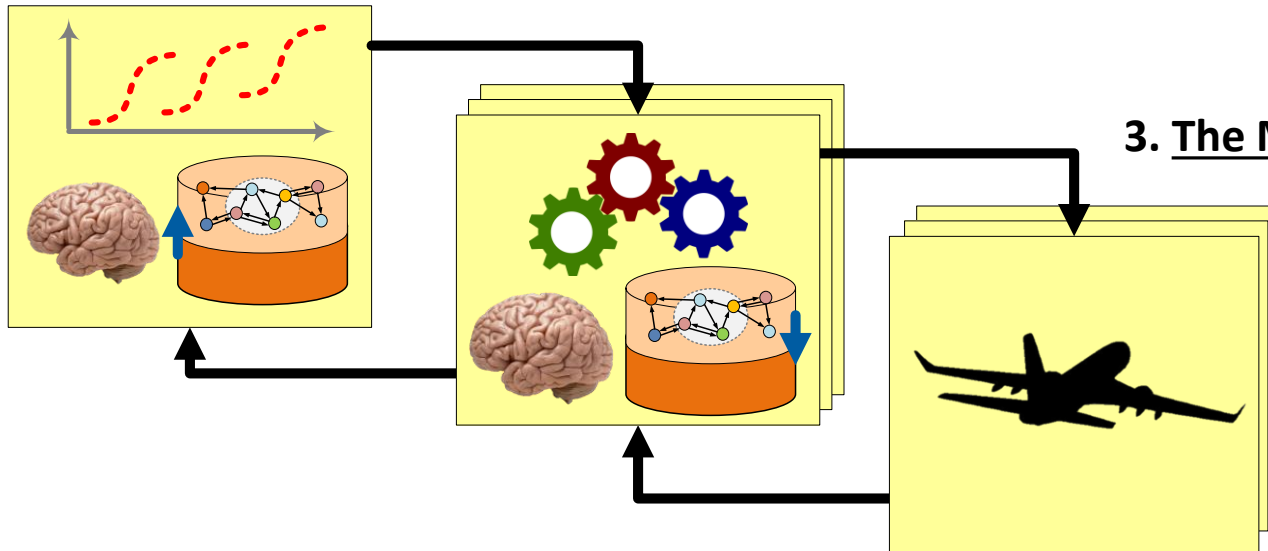

More about the ASELCM Pattern

Utilizes the Model Trust by Groups Phenomenon template twice, in order to also innovate the engineering process itself:

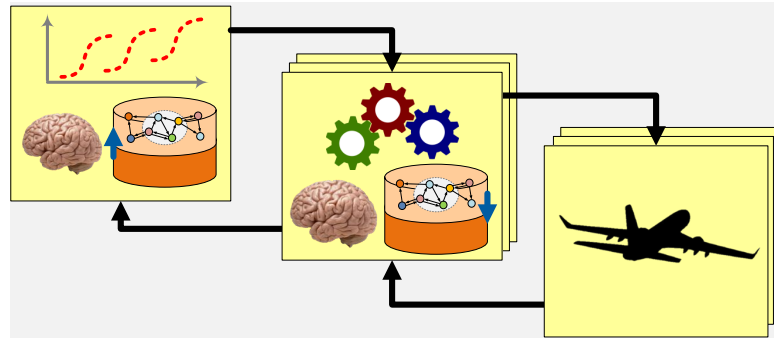

Learning is not accumulation of information,
it is improvement of behavior

For our purposes, effective learning is not accumulation of information in models or other forms of retained data—instead, it must be change in behavior as a result. That is part of why the third box appears in the Model Trust by Groups Phenomenon—it is not “learning” for our purposes if it does not effectively impact future behavior.

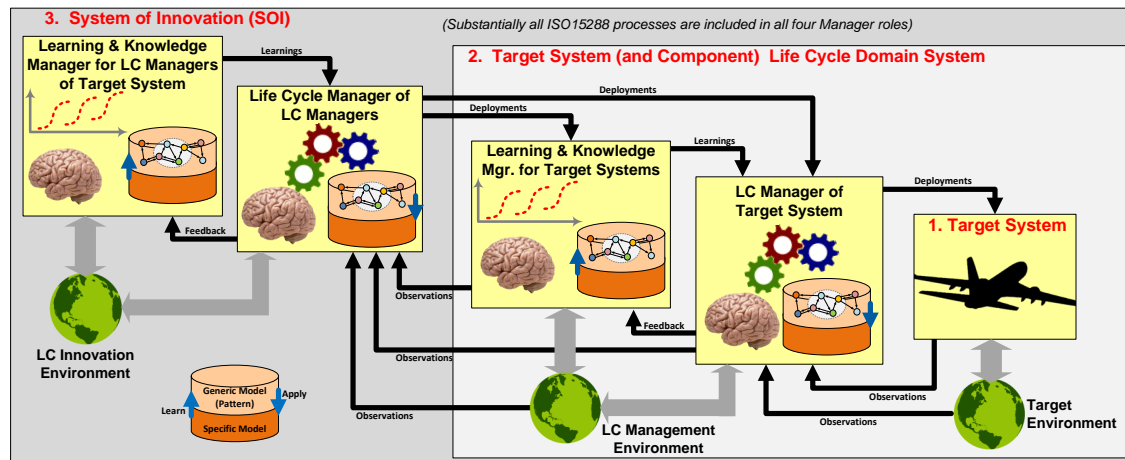

INCOSE ASELCM Pattern (aka System of Innovation Pattern): *Descriptive reference framework, not prescriptive—describes learning in all systems of innovation, whether model-based or not, whether effective or ineffective*

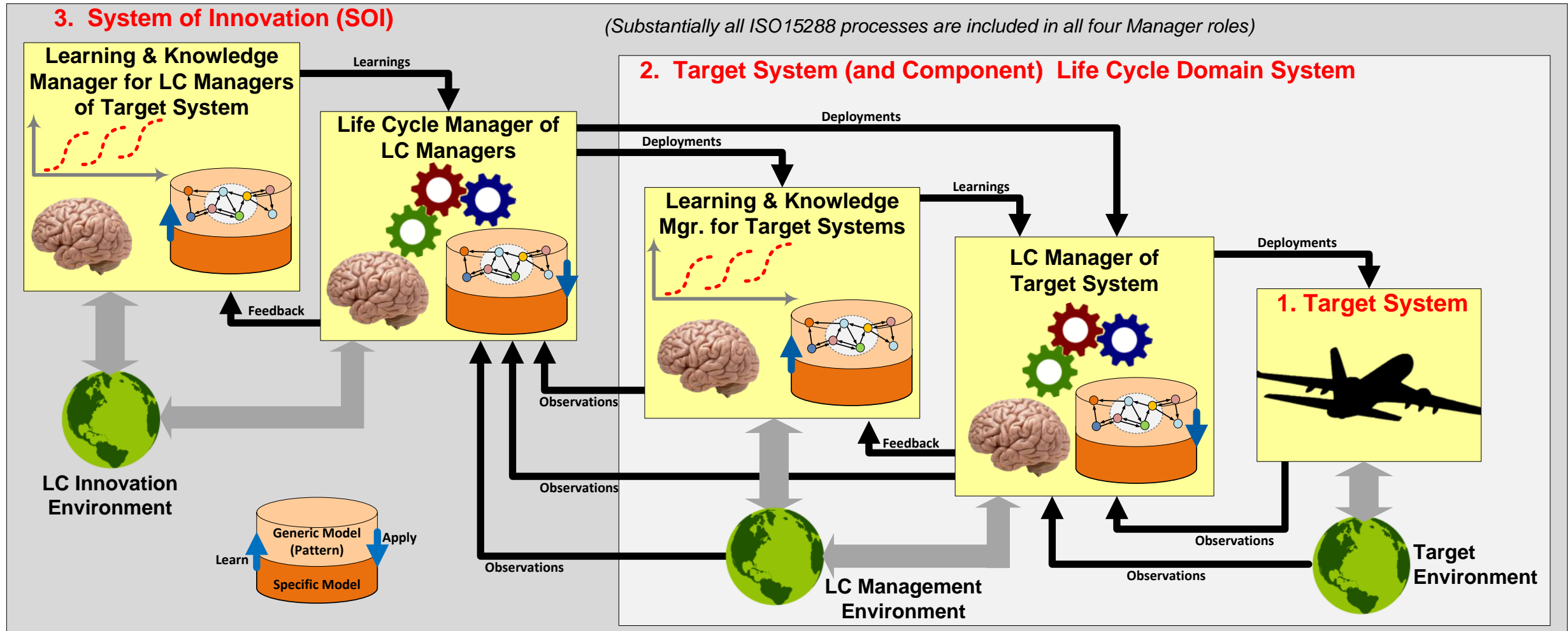

- **System 1:** The Target System, or system of interest, subject of engineering or other life cycle management attention.
- **System 2:** The environment with which System 1 interacts over its life cycle, including in particular the life cycle management systems that plan, engineer, produce, distribute, install, sustain, or observe System 1 over its life cycle.
- **System 3:** The life cycle management systems that plan, engineer, produce, distribute, install, sustain, or observe System 2 over its life cycle.

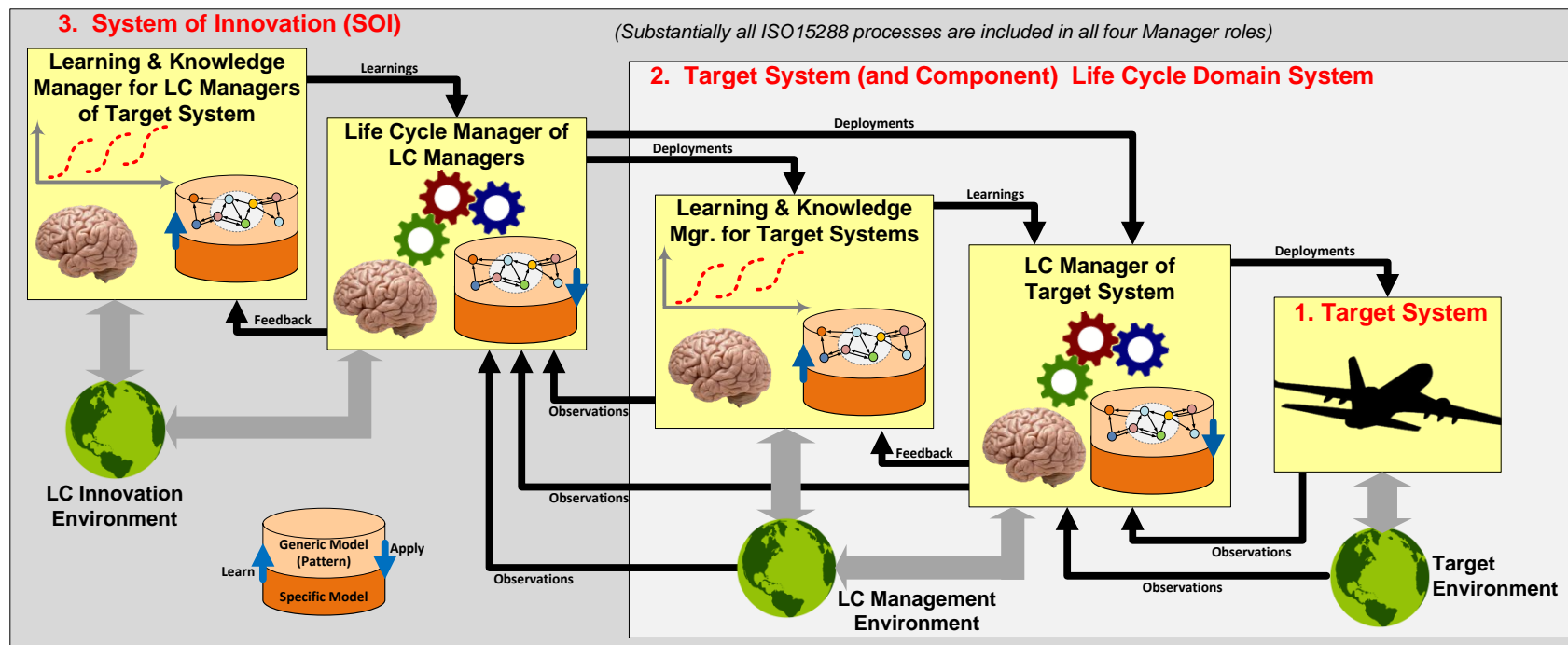

- ISO15288 shows us all the things we'd need to do if we knew nothing about a given domain, by illustrating all the processes and information that should be sought out and combined.
- But, what about what we already knew? ISO15288 is relatively silent on this.
- The INCOSE ASELCM Pattern (Agile SE Life Cycle Management Pattern) (aka Innovation Ecosystem Pattern) is a model-based enterprise view of any innovation ecosystem (e.g., engineering organization, enterprise, living system, etc.) concerned with progressive innovation over the life cycle of systems.
- It is a descriptive reference pattern, built upon ISO 15288, to describe/analyze any past, current, or future such entity, with an emphasis on the capabilities of that entity to take advantage of both what has been learned in the past as well as new learning, and how they are managed and combined.

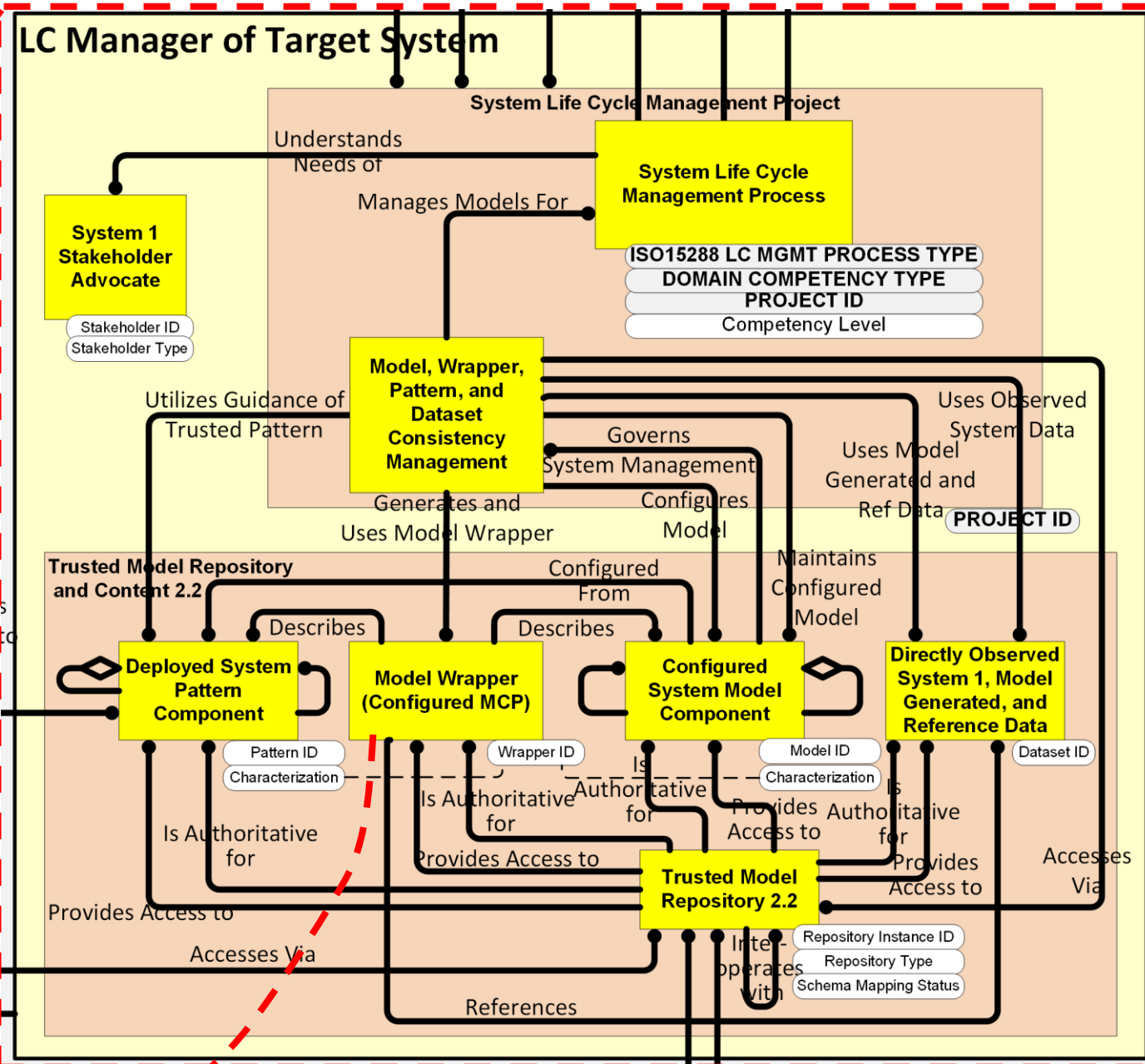
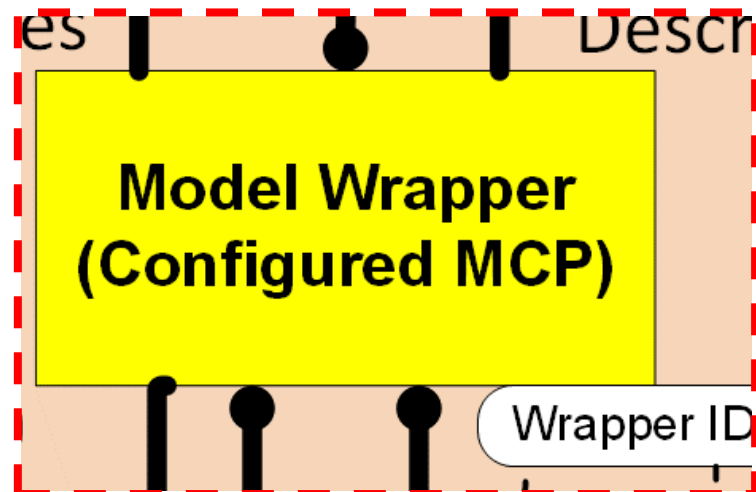
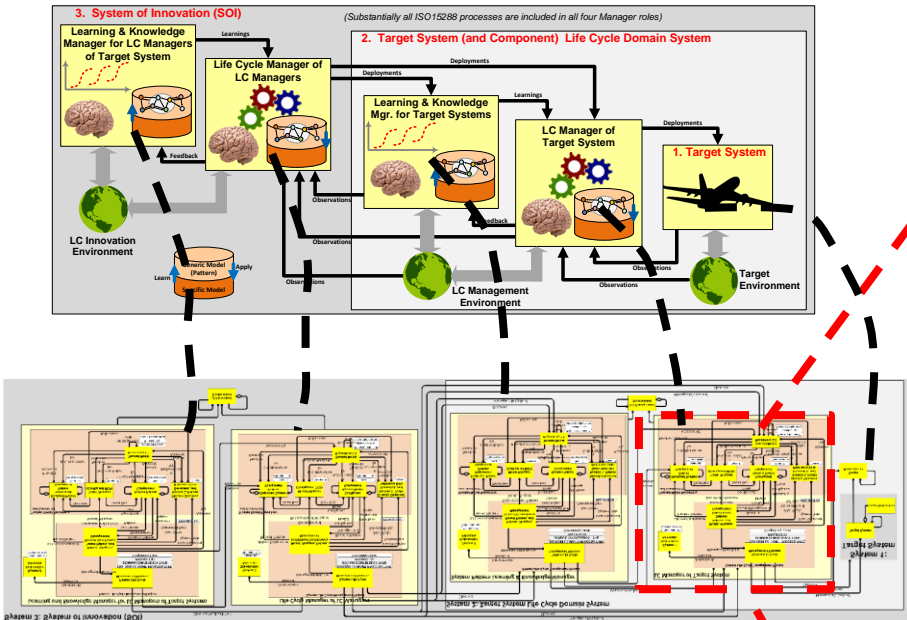

One block of "Vee diagram"

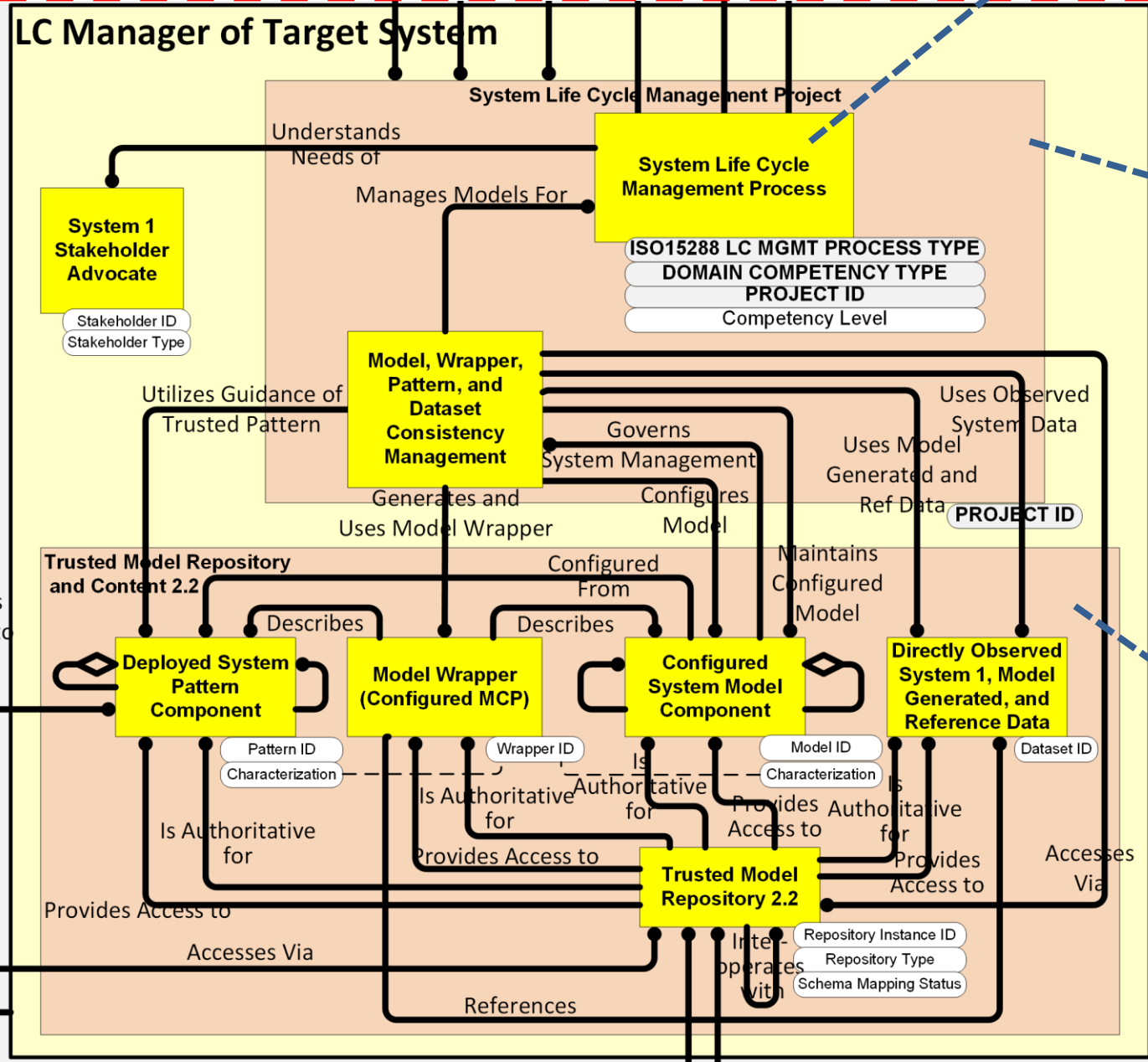

Business Process Roles, traditionally performed by people. Usually a social network, subject to human strengths and weaknesses.

Information and Repository roles, performed by human brains, paper, IT systems, or hybrid thereof. To the degree it is human-performed, also a social network.

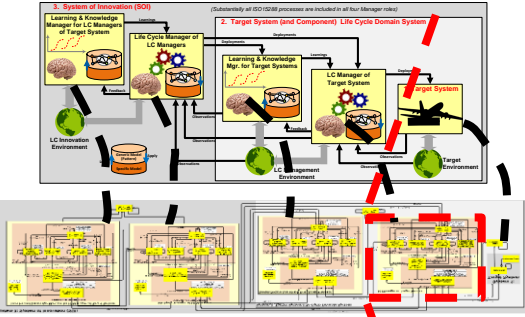

One block of "Vee diagram"

Called the "Endeavor" by the SEMAT software process model

Business Process Roles, traditionally performed by people. Usually a social network, subject to human strengths and weaknesses.

Information and Repository roles, performed by human brains, paper, IT systems, or hybrid thereof. To the degree it is human-performed, also a social network.

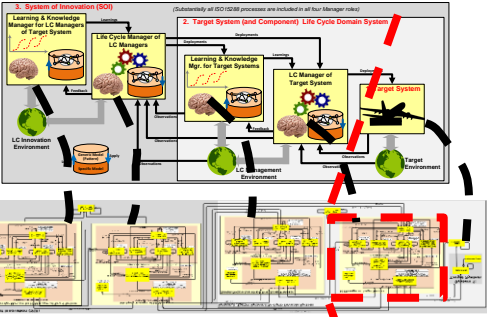
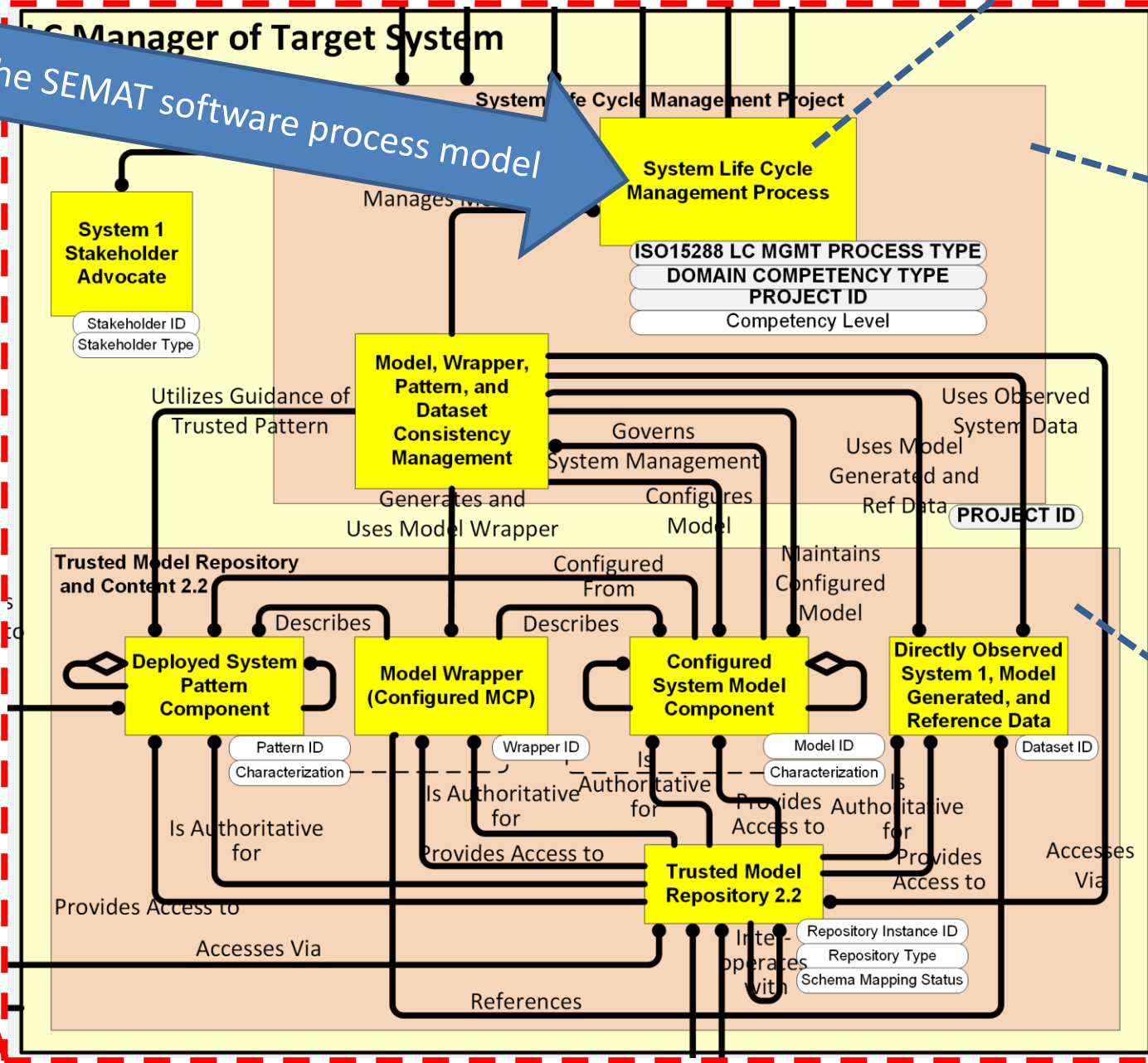

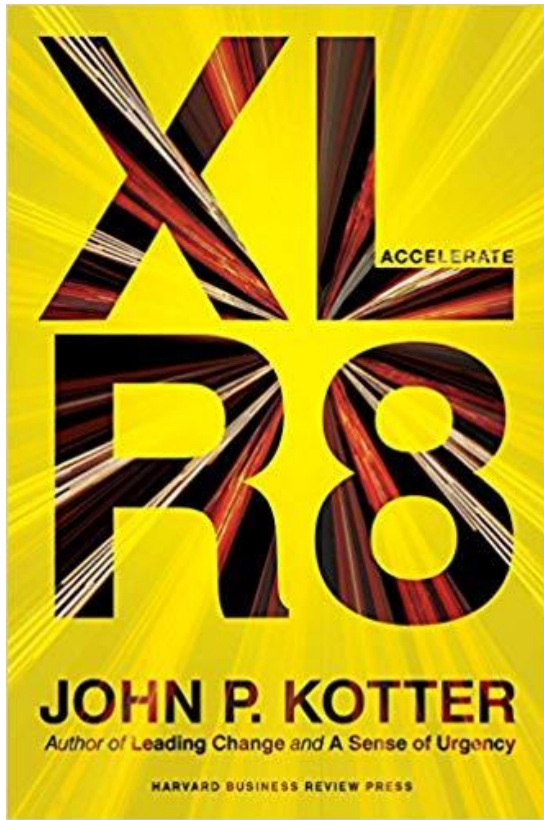

(Kotter 2014)

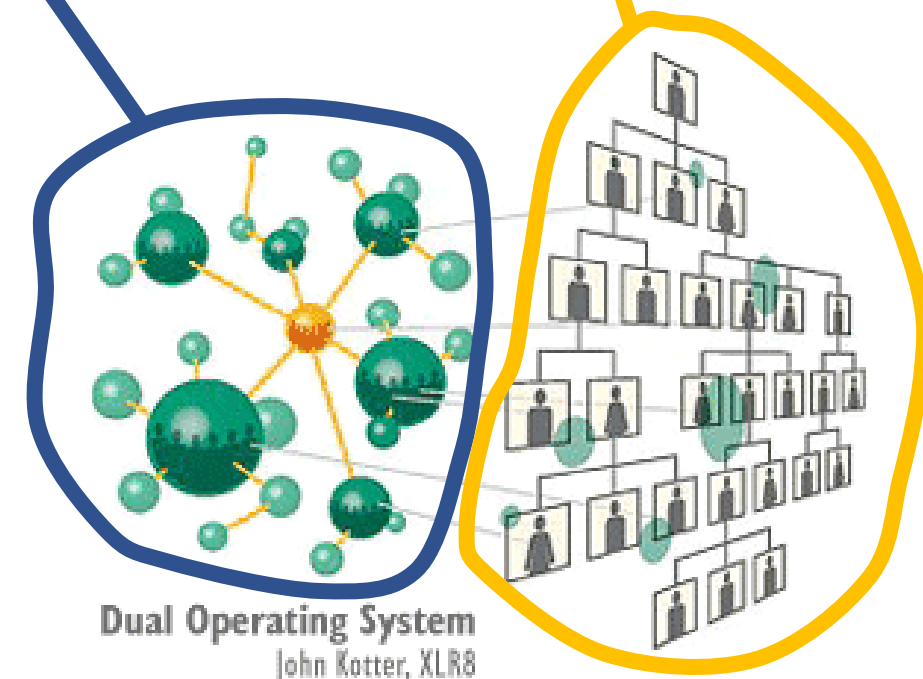
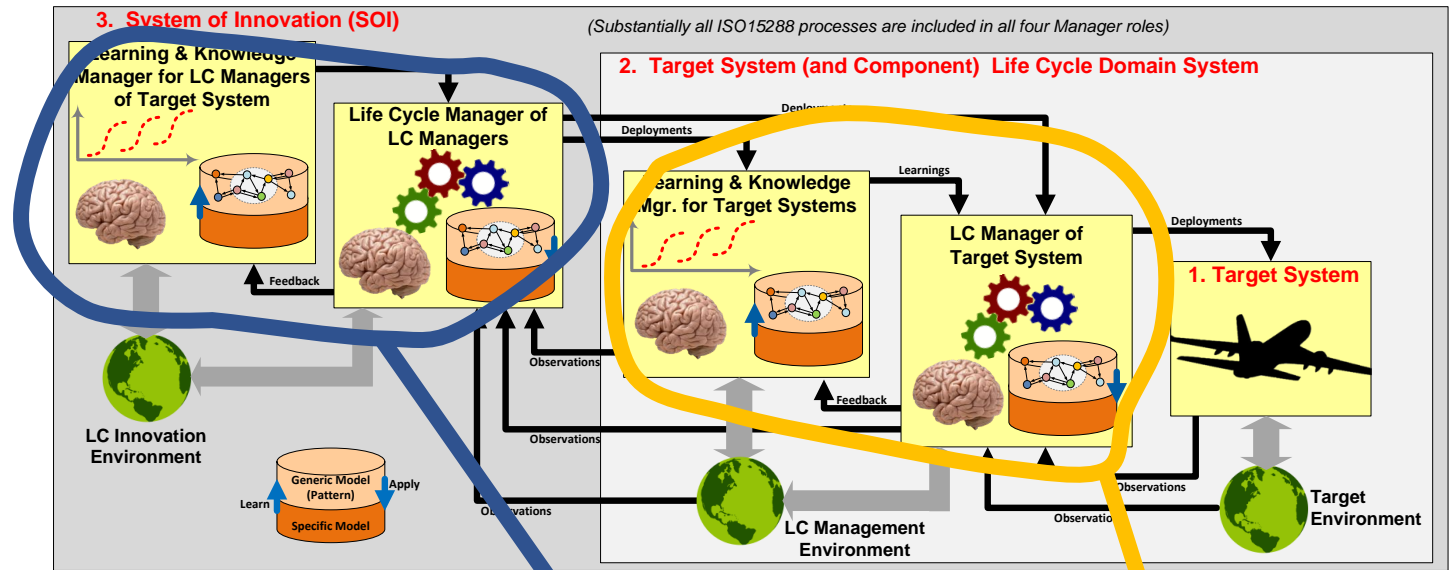

Dual Operating System
John Kotter, XLR8

- System 3 is directly related to Organizational Change Management (OCM) for transformation.
- System 3 and 2 together reflect John Kotter’s “dual operating system” approach to leading change. (Kotter 2014) (Think of logical roles, in some case performed by same physical people.)

Related Constructs

- Model Characterization Pattern (MCP) (AKA “Model Wrapper”):
 - Metadata that characterizes (models) any virtual model of interest, of any type (FEA or CFD simulations, MBSE models, Systems Dynamics Models, data-driven Neural Network models, etc.).
 - Becomes a universal label (wrapper) for managing large libraries of disparate models, as well as understanding intent, credibility and provenance of any model.

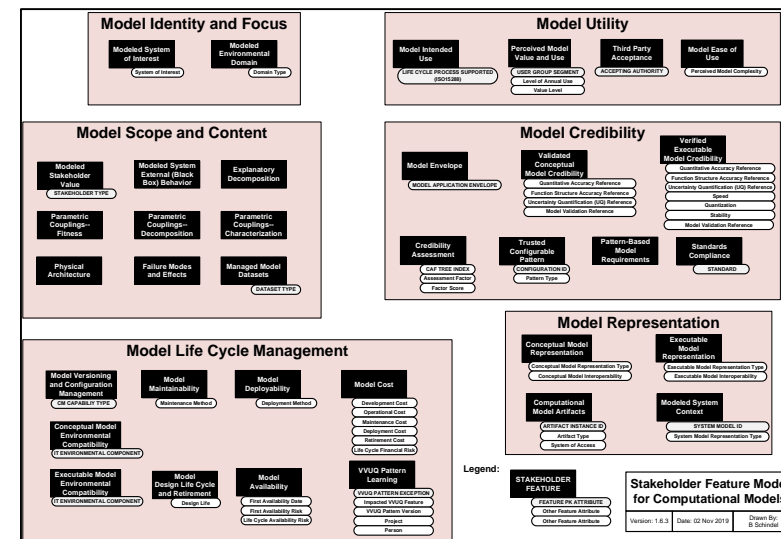
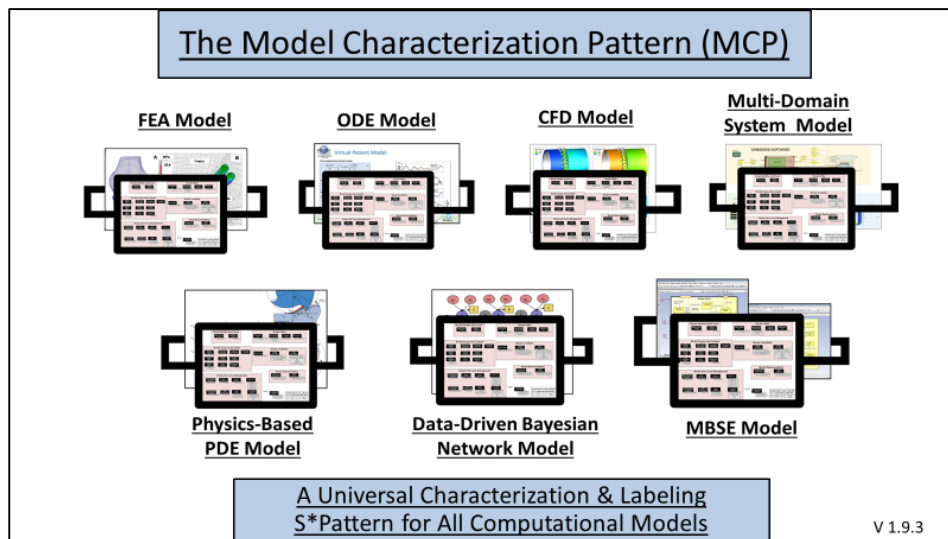

Related Constructs

- Model Credibility and Credibility Assessment Frameworks (CAFs):
 - Generalized tree-based framework for describing why anyone (or any team or enterprise) has awarded a degree of trust in a model.
 - Used by US NRC and other entities.
 - Built into the Model Characterization Pattern (MCP) (wrapper)

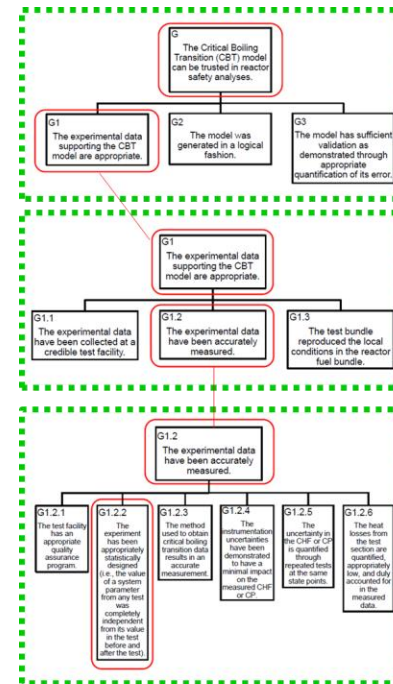
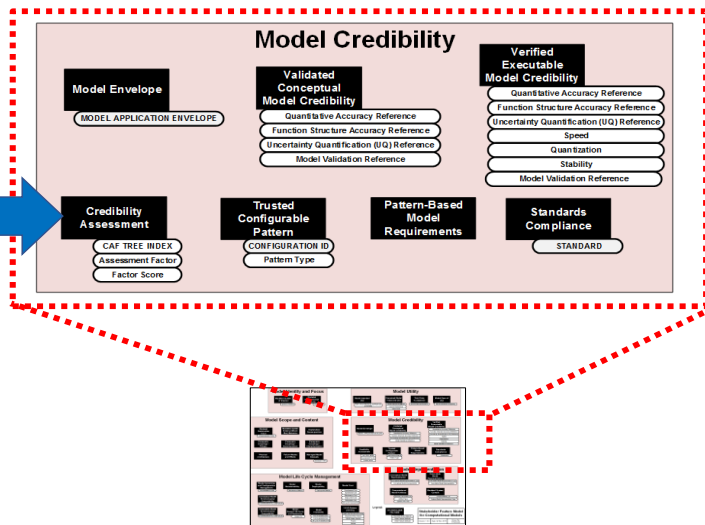
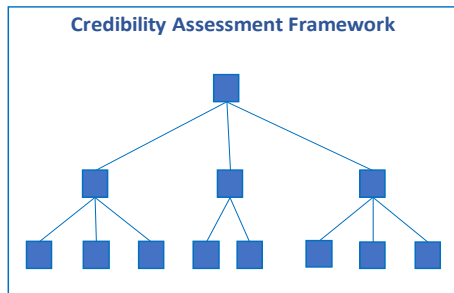

Credibility Assessment Framework Example

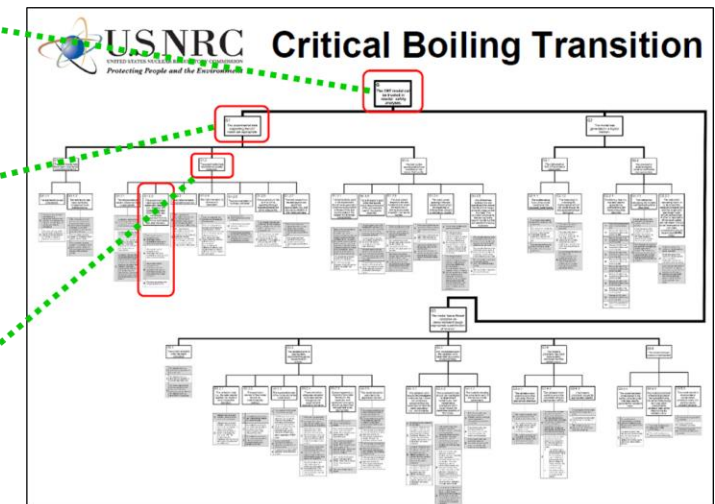

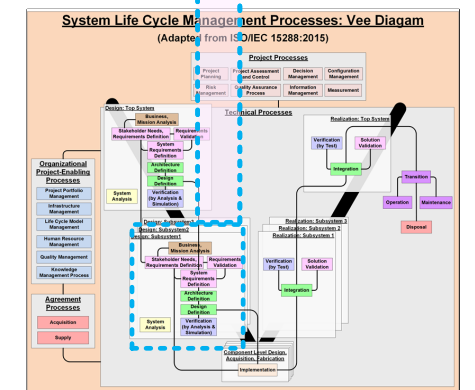
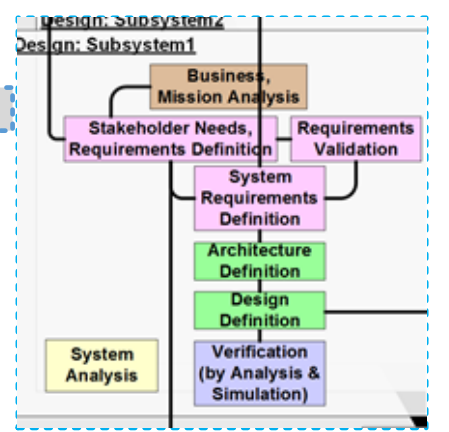
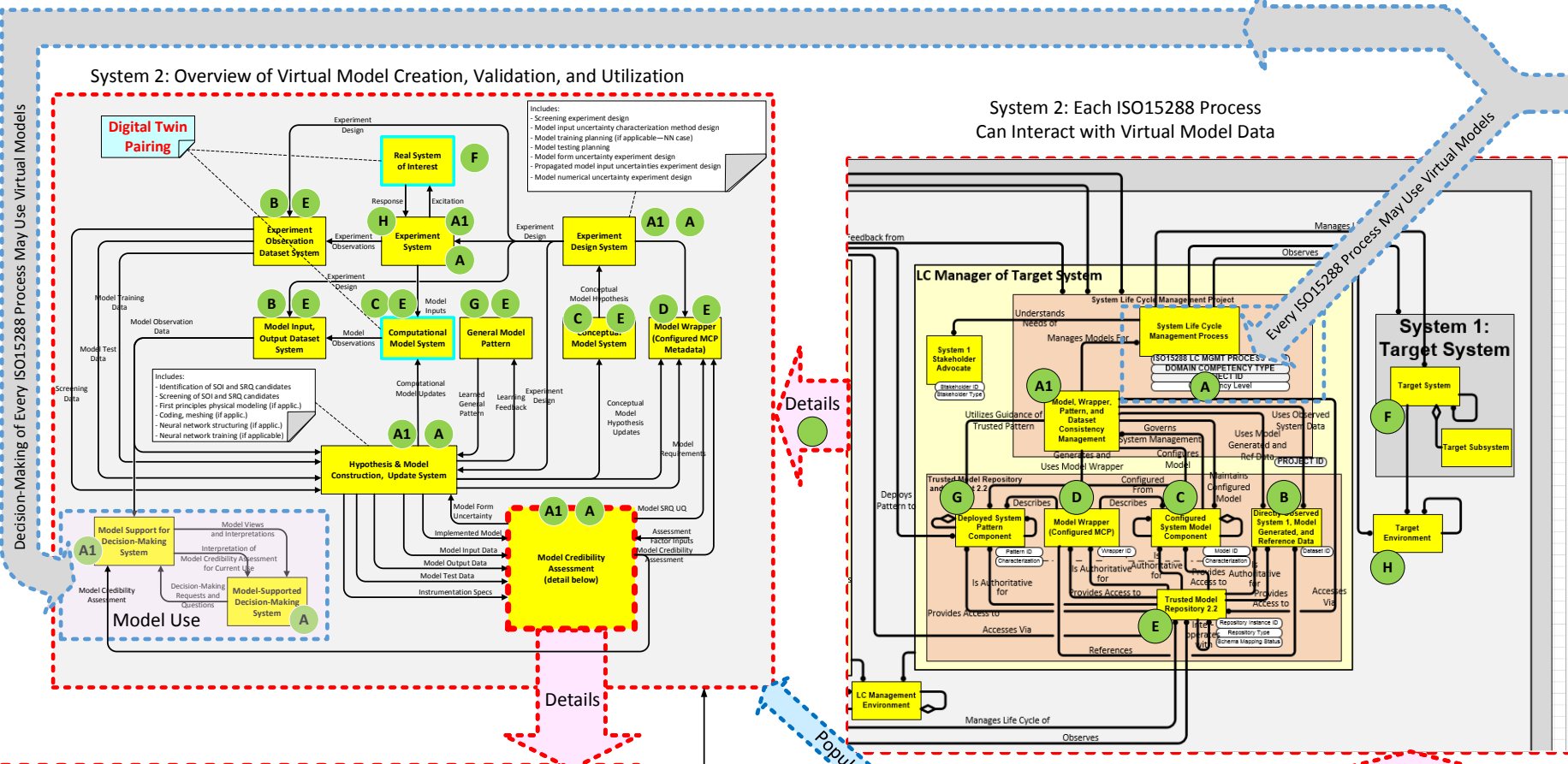

ISO15288 Processes ("Vee Diagram") – Basis of the INCOSE SE Handbook

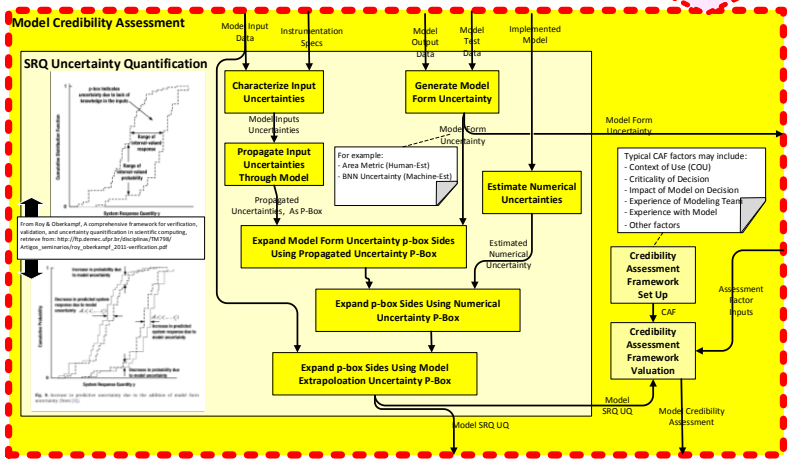

Virtual Model Credibility Assessment-- including Model Verification, Validation, Uncertainty Quantification (VVUQ)

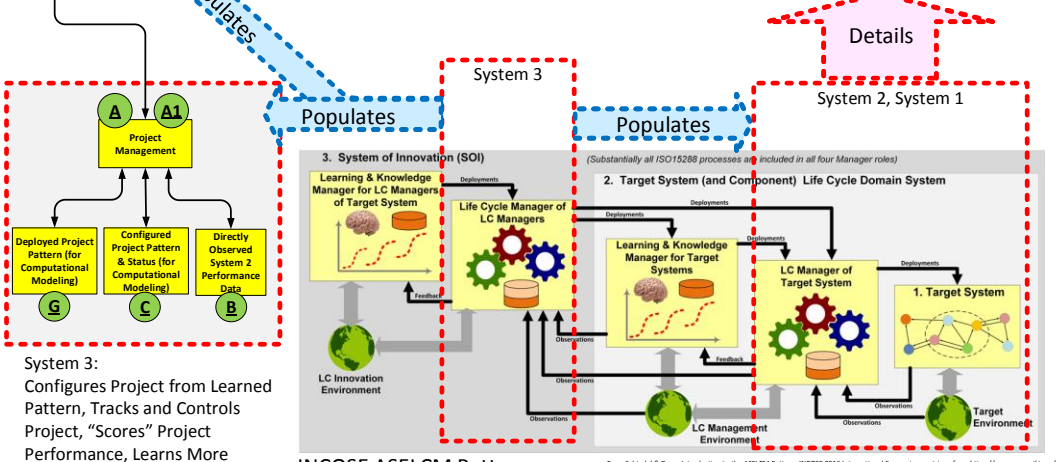

INCOSE ASELCM Pattern – Virtual Learning Ecosystem Framework

Modeling, Model VVUQ, and Model Use: ASELCM Ecosystem Overview Levels
V1.4.2 03.05.2020

From Schindler & Dove, Introduction to the ASELCM Pattern, INCOSE 2016 International Symposium, retrieved from https://www.omg.wiki/wiki/MBS/16/tech.php?media=mbsepatterns2016_intro_to_the_aseclm_pattern_v1.4.2.pdf

Economics: Rapidly Configuring Trusted Models from Trusted S*Patterns

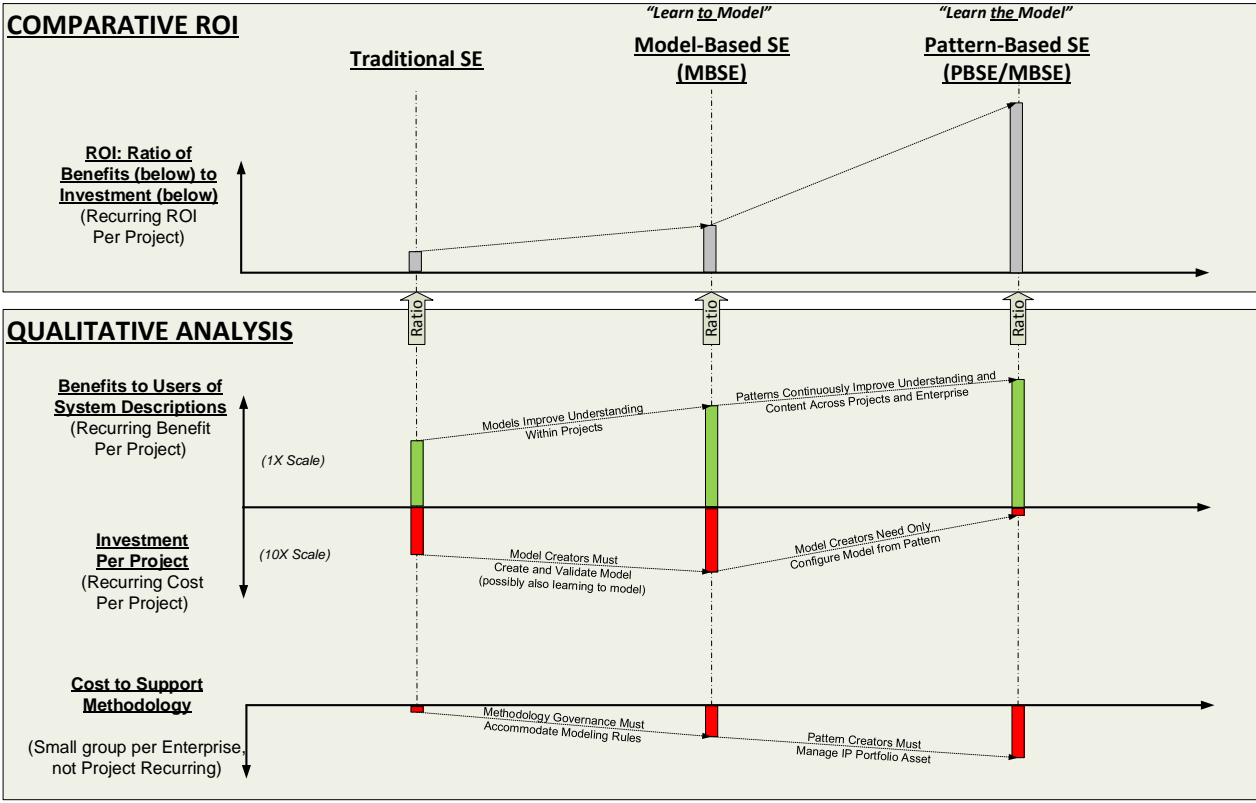
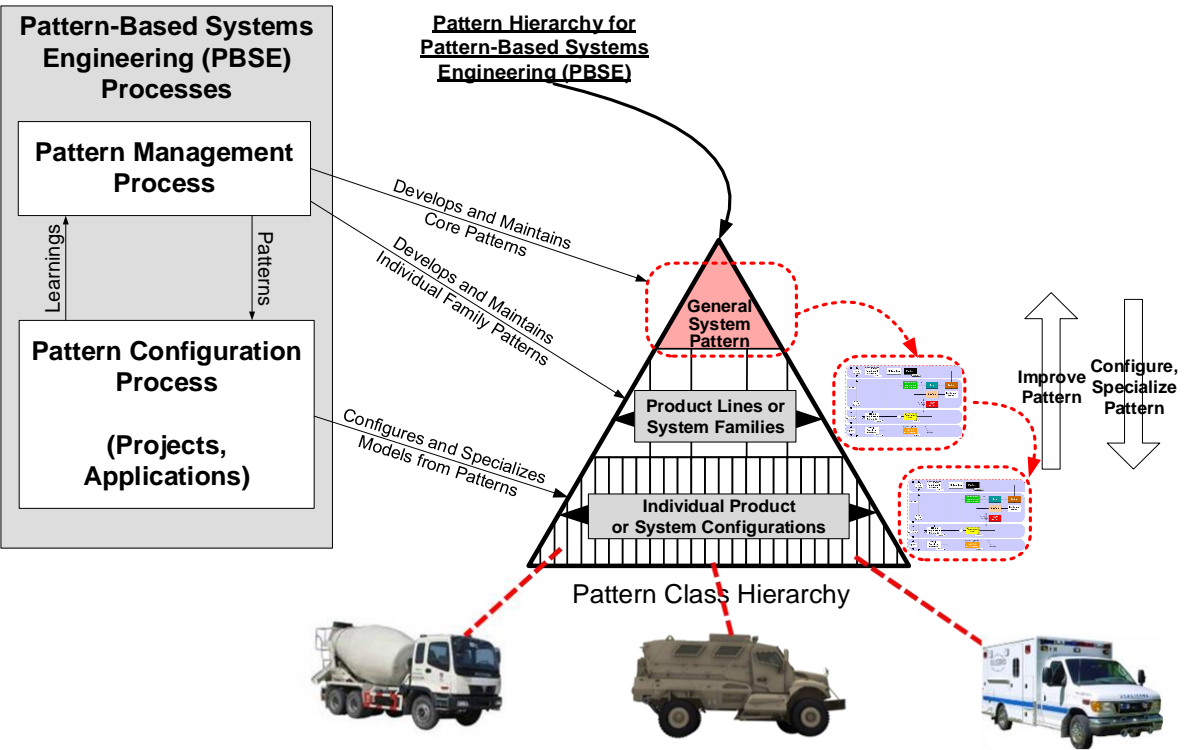

- Generates high quality first draft models from patterns in <10% of the time and effort to generate “traditional” models of lower quality and completeness.
- Most planned S*Patterns take less than 90 days to generate to point of first use, via “Uncover the Pattern” (UTP).
- Thereafter, S*Pattern becomes the point of accumulation of future group learning--the “muscle memory” that is automatically consulted by configuration in each future project.

- Pattern data as IP, and a proxy for group learning:
 - Information Debt, not just Technical Debt, as a foundation of adaptive, agile innovation.
 - Patterns can be capitalized as financial assets under FASB 86.
- “Patterns as capital” changes the financial logic of project level SE “expense”

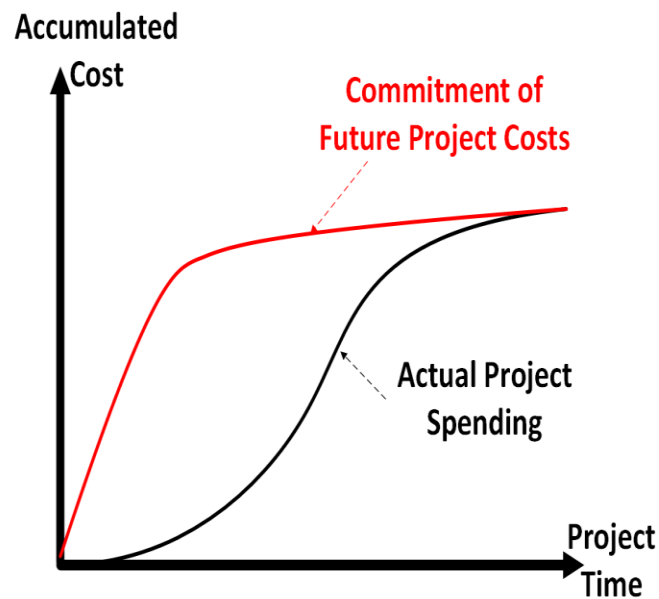

(a) When Project Costs Are Committed versus Incurred

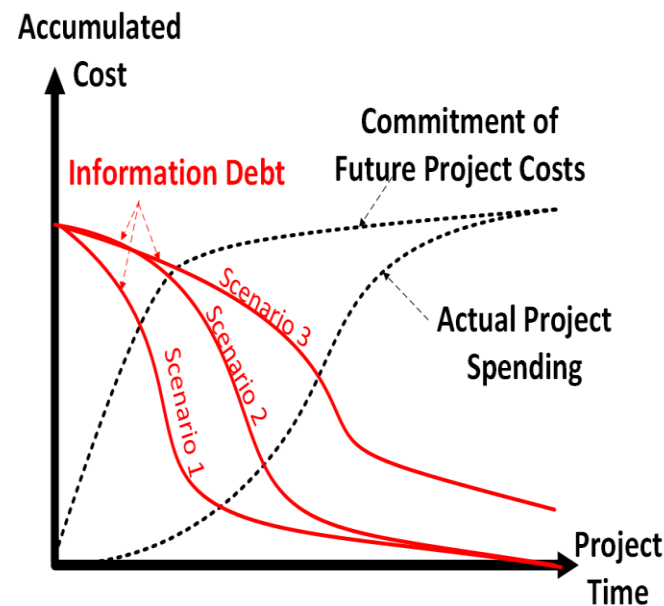

(b) Information Debt is Reduced Over the Course of Project

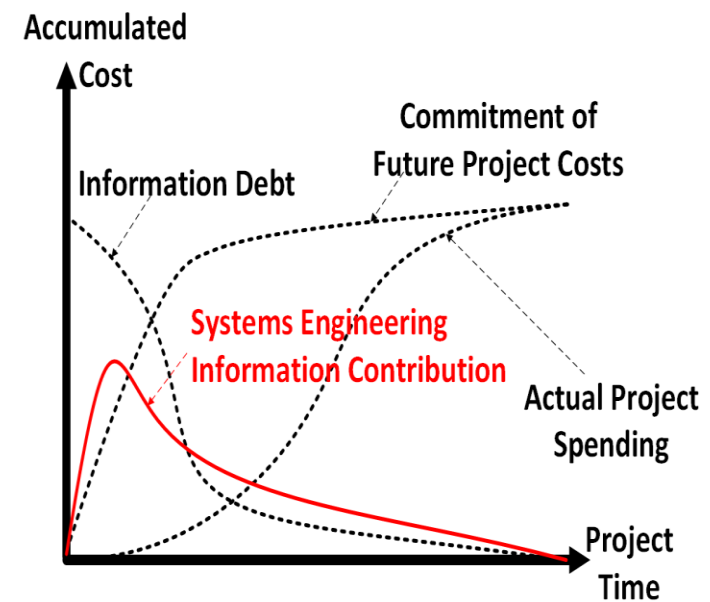

(c) Systems Engineering Information Is Generated to Reduce Information Debt

From Dove, Garlington, and Schindel, “Case Study: Agile Systems Engineering at Lockheed Martin Aeronautics Integrated Fighter Group”, from *Proc. of INCOSE 2018 International Symposium*, 2018, Washington.