



27th annual **INCOSE**
international symposium

Adelaide, Australia
July 15 - 20, 2017



MBSE Patterns Working Group

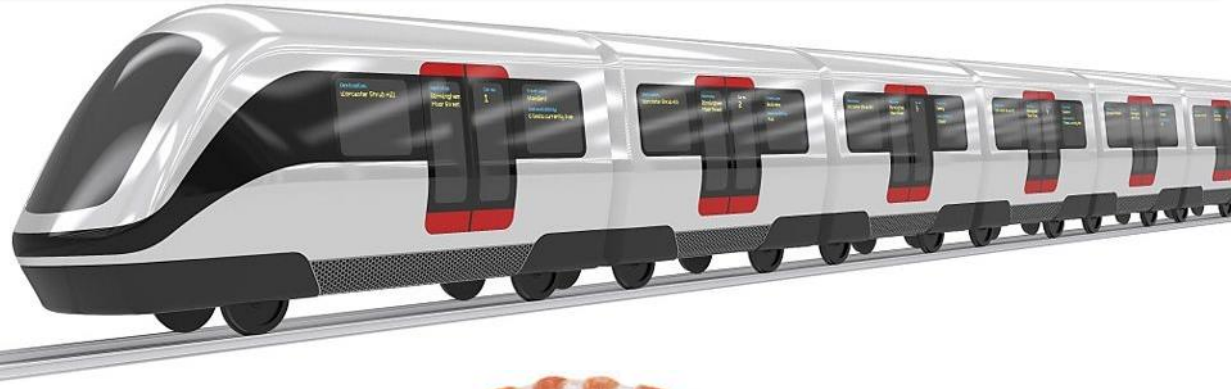
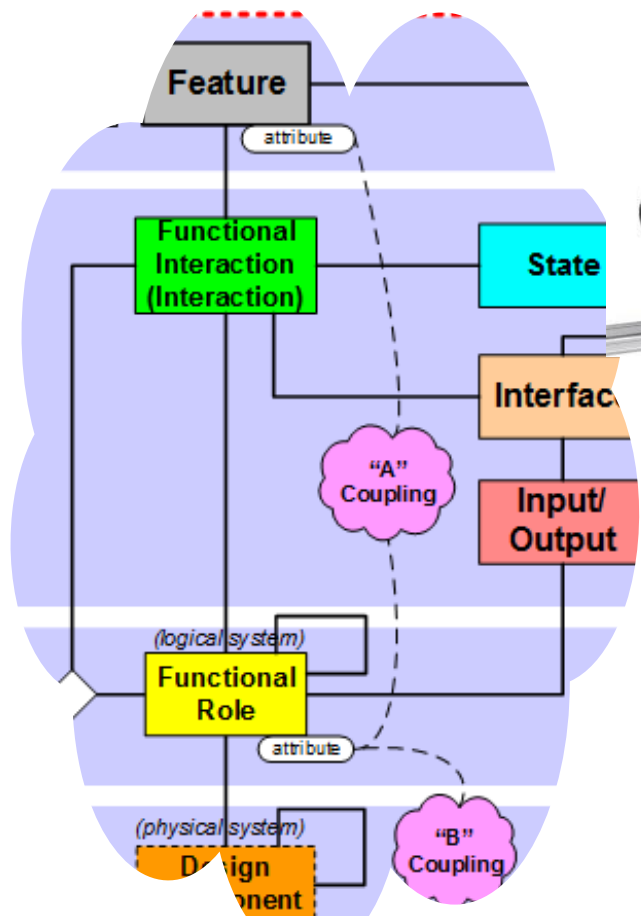
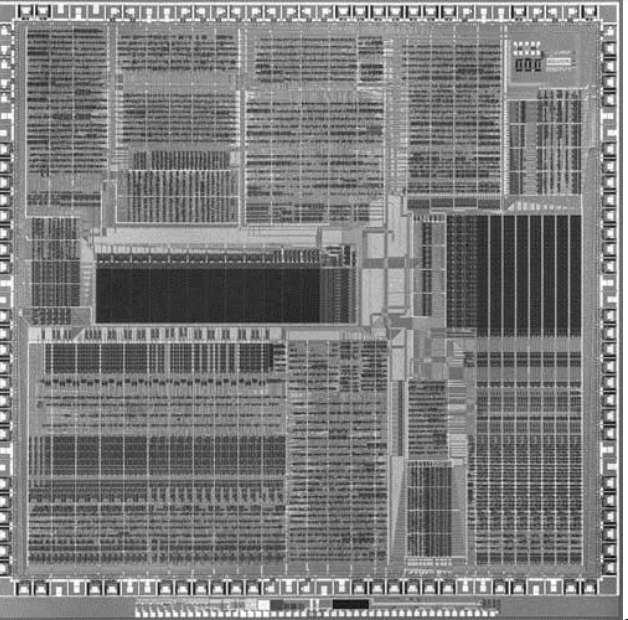

Contents

- MBSE Patterns WG:
 - Who we are—including our partners
 - Recent activities
 - IW2017 activities—when and where to find us
 - How to get involved
 - Current example: Interface Patterns Project



- Joint Activities Materials:
 - With Agile SE WG: Joint Activity Materials
 - With Product Line Engineering WG: Joint Activity Materials
 - With ASME Model V&V Committees: Model V&V Joint Activity Materials
 - With SoS WG: Joint Activity Materials
 - With Health Care WG: Joint Activity Materials
 - With Critical Infrastructure Protection, and Recovery WG: Joint Activity Materials
 - With Systems Science WG: Joint Activity Materials
 - With Tools Interoperability & Model Life Cycle Management WG: Joint Activity

- Patterns WG Planning and Support:
 - Roles as formal INCOSE WG and MBSE Challenge Team
 - New web site
 - Future projects
 - Interest in current and future activities
 - Open discussion

- References
- Example S*Pattern Content

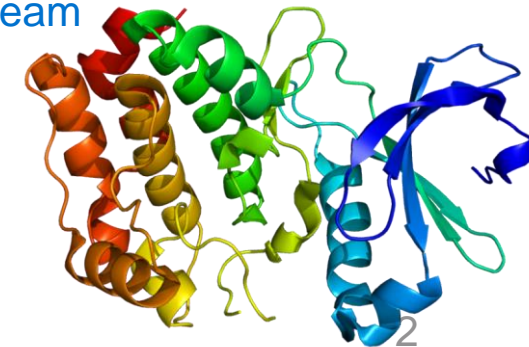
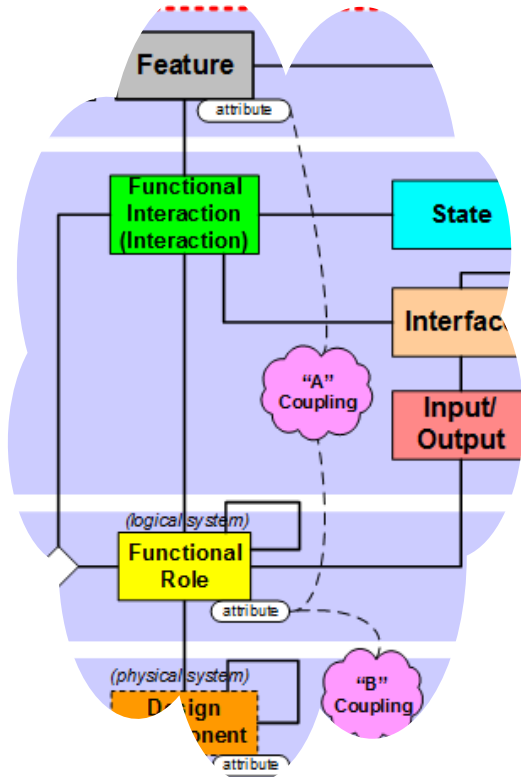



We began three years ago, as the MBSE Initiative Patterns Challenge Team:

- Part of the joint INCOSE/OMG MBSE Initiative, formed years earlier as MBSE Patterns Challenge Team.
- In 2016, our team formally became the INCOSE MBSE Patterns Working Group
- Because of our MBSE focus, and in order to continue to support the MBSE Initiative, we continue to also be listed as part of that INCOSE/MBSE Initiative

This Working Group is concerned with configurable, re-usable system models: “S*Patterns”

1. Models containing a certain minimal set of elements are called S*Models (S* is short for “Systematica”)
2. Those underlying elements are called the S*Metamodel, which was inspired by the physical sciences
3. S*Models using those elements may be (have been) expressed in any modeling language (e.g., SysML, or other languages)
4. S*Models can be (have been) created and managed in many different COTS modeling tools.
5. Re-usable, configurable S*Models are called S*Patterns
6. By “Pattern-Based Systems Engineering” (PBSE) we mean MBSE enhanced by these generalized assets
7. These are system-level patterns (models of whole managed platforms), not just smaller-scale component design patterns

The INCOSE Patterns Working Group: Who are we?



- Our most active members come from across diverse domains:
 - Automotive
 - Advanced Manufacturing
 - Aerospace
 - Consumer Products
 - Defense
 - Health Care, Medical Devices, Pharmaceuticals
 - Others
 - Today's attendees?
- During the last four years, over 200 colleagues have participated in Patterns Working Group activities:
 - Team meetings, work sessions, tutorials, meetings with other groups
 - Construction of system patterns
 - Writing related papers for IS, IW, and regional INCOSE conferences
 - Invited presentations of our team's work to INCOSE chapter meetings

Working group web site:

<http://www.omgwiki.org/MBSE/doku.php?id=mbse:patterns:patterns>

Meeting web site:

http://www.omgwiki.org/MBSE/doku.php?id=mbse:patterns:patterns_challenge_team_mtg_07.15-17.17

Working Group Partners in Progress

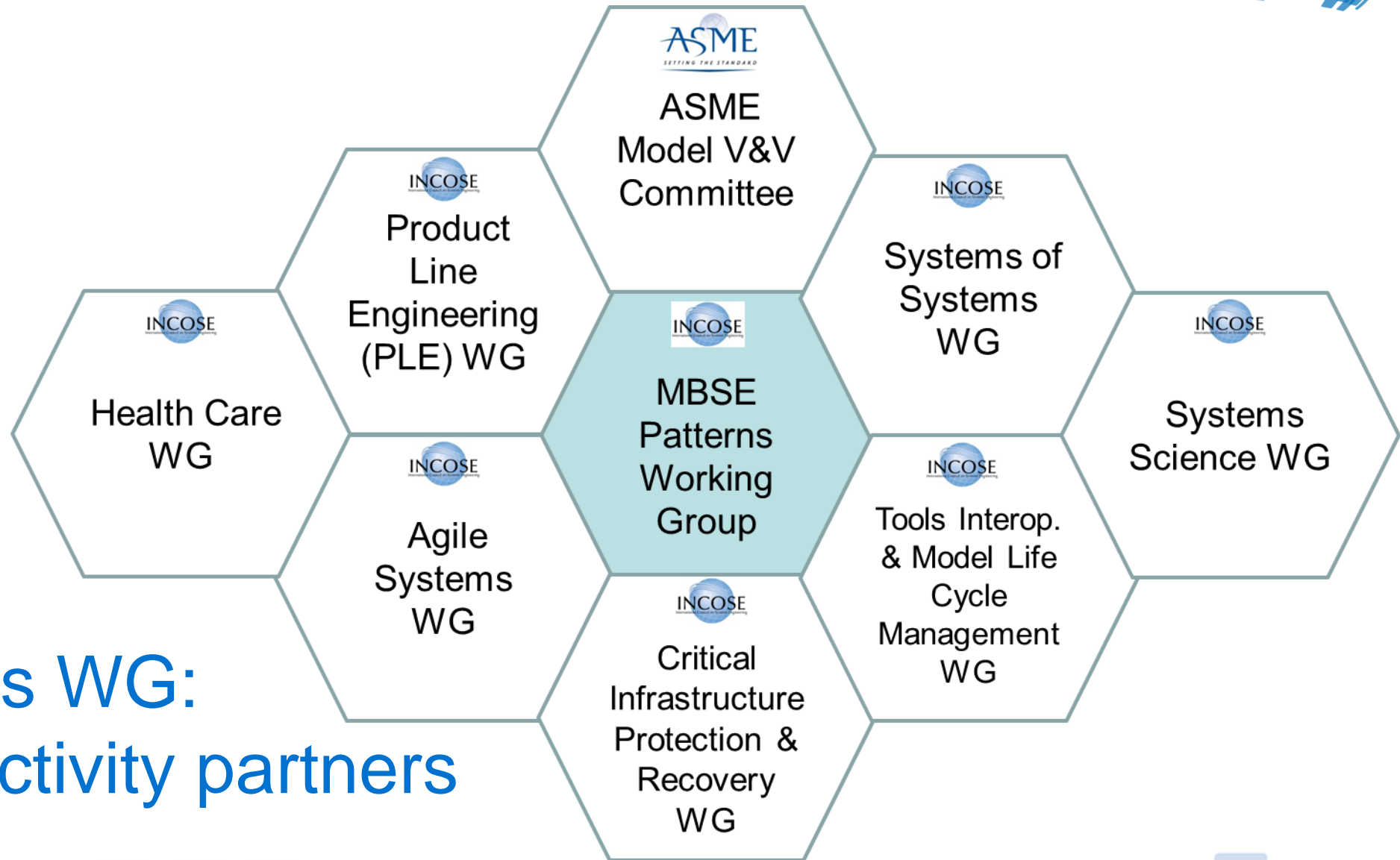

MBSE Patterns WG:
Current joint activity partners

Working Group Partners in Progress



Primary Contact:
*Rick Dove, Paradigm
Shift, Intl.*

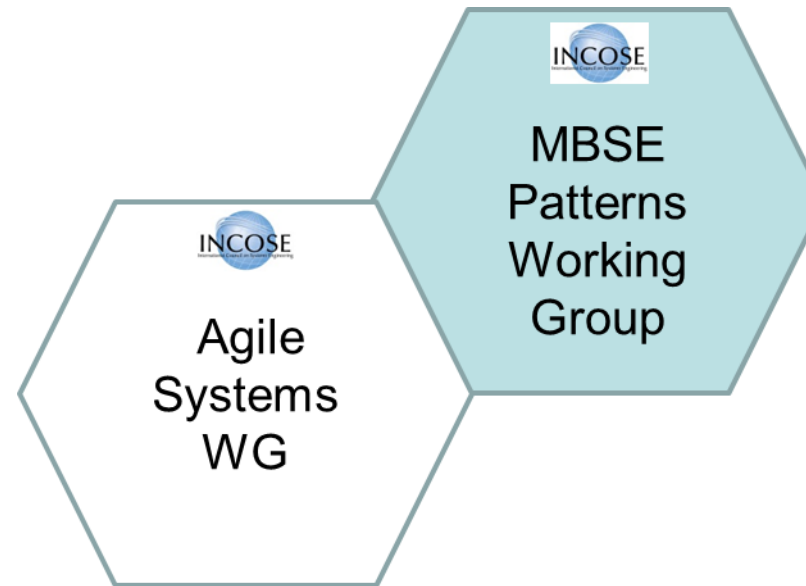

Agile Systems Engineering Life Cycle Management
(ASELCM) Discovery Project: Creating, validating ASELCM S*Pattern

Working Group Partners in Progress



Primary Contact:
Chris Unger,
GE Health Care

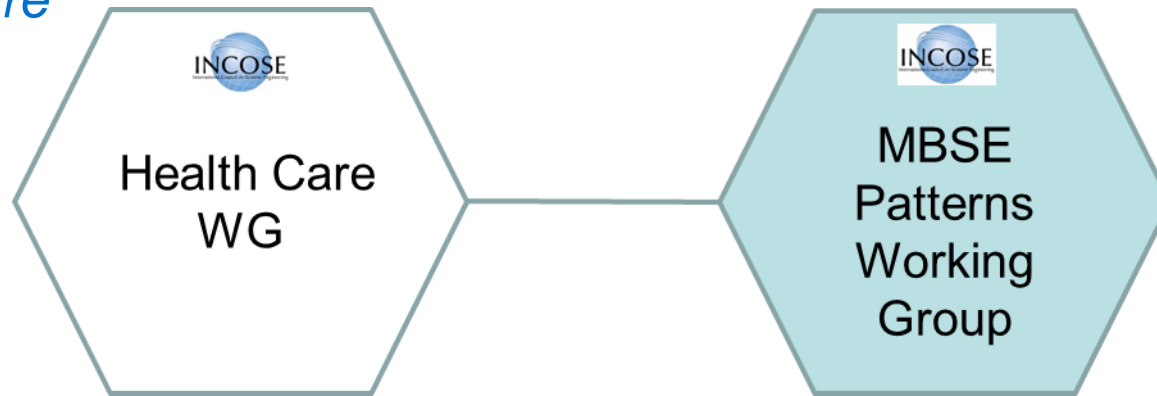

Supporting the INCOSE Agile Health Care Systems Conference
(third year) & the Health Care version of ASELCM Pattern

Working Group Partners in Progress

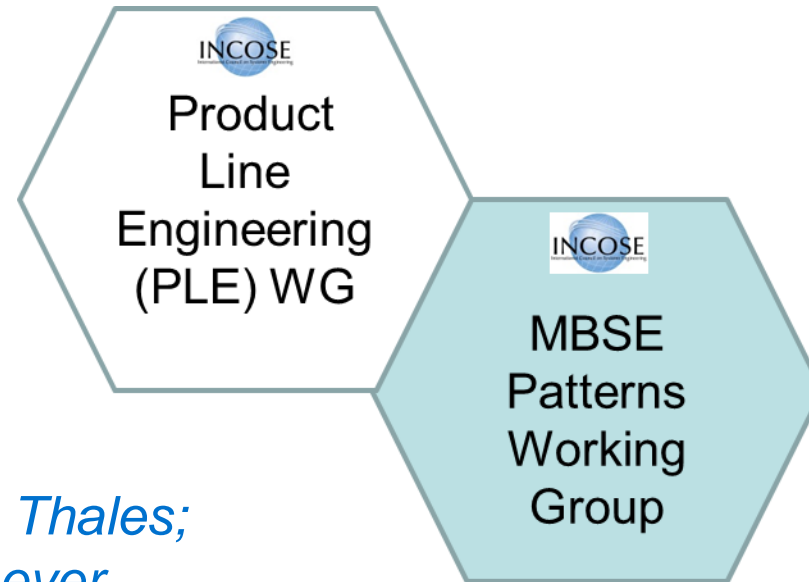

Primary Contacts:

*Guillermo Chale-Gongora, Thales;
Charles Krueger, Big Lever*

Joint demonstration of Legacy Product Line Pattern Harvest and Ecosystem for Product Line Life Cycle Patterns & Configurations

Working Group Partners in Progress



Primary Contact:
Joe Hightower, Boeing,
Gordon Shao, NIST,
ASME VV50 Committee

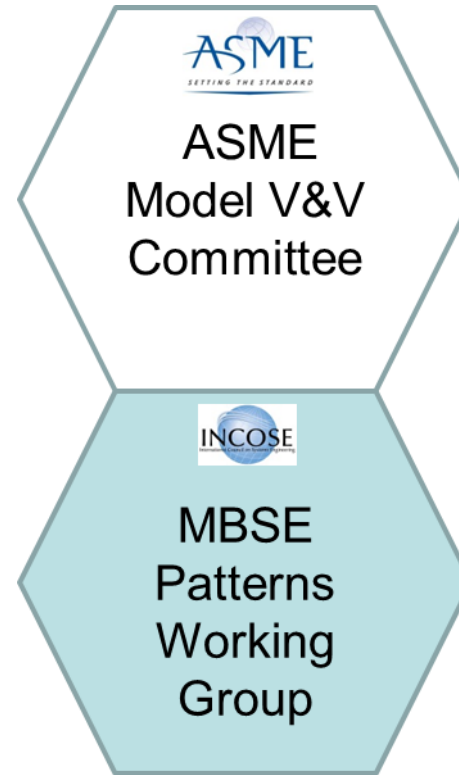

Supporting creation of ASME Guidelines & Standards for
Verification, Validation, Uncertainty Quantification of
Computational Models, over their Life Cycles

Working Group Partners in Progress

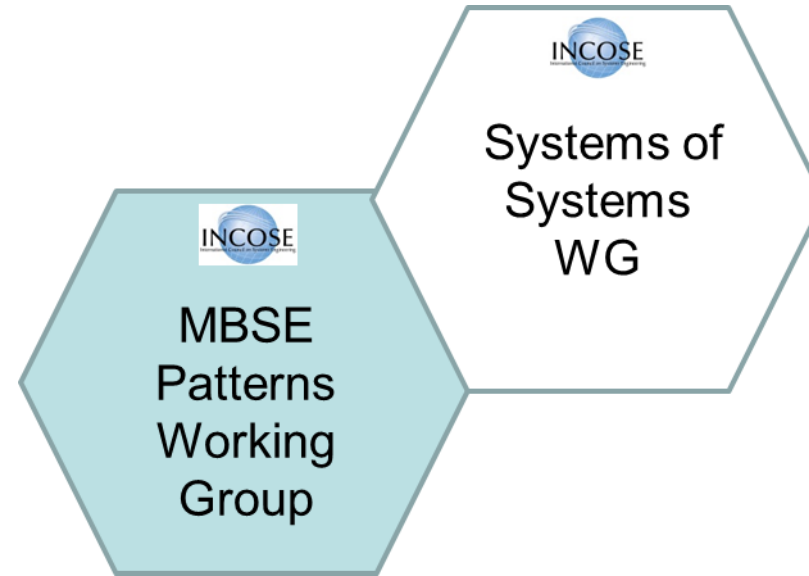

Primary Contact:
*John Fitzgerald,
Newcastle U.*

Support of SoS Pattern Library, including
build-out of S*Metaclasses

Working Group Partners in Progress

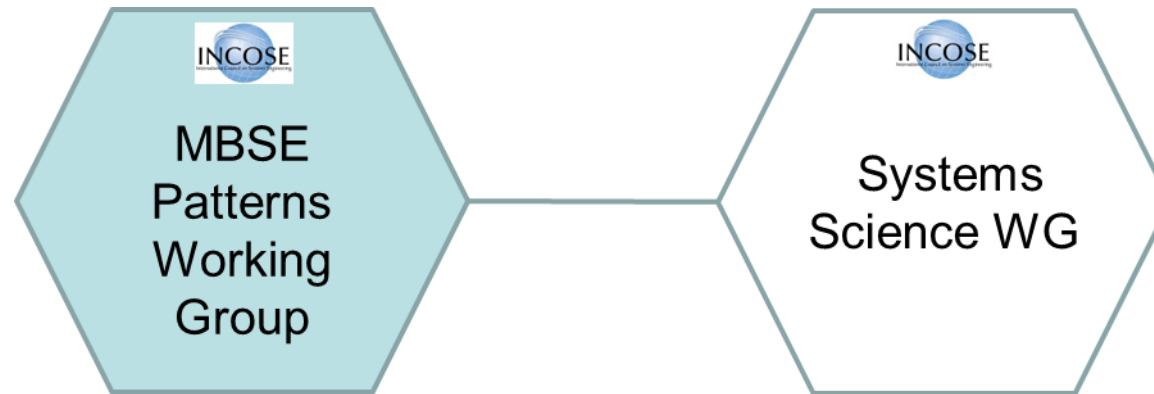

Primary Contact:
*David Rousseau, Centre
for Systems Philosophy*

**S*Interactions & S*Patterns as
a basis for a hard science of systems**

Working Group Partners in Progress

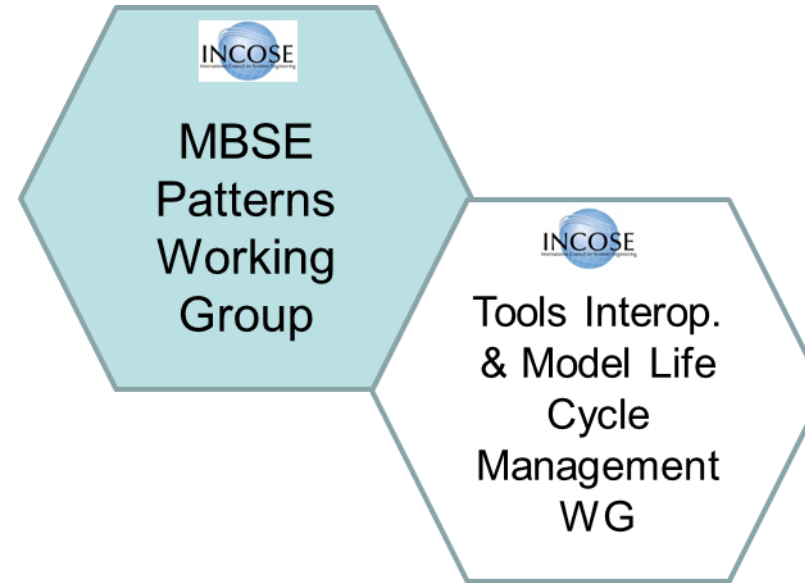

Primary Contact:
Lonnie VanZandt, Sodius

Patterns of collaboration in future innovation ecosystems,
including illustrative content

Working Group Partners in Progress

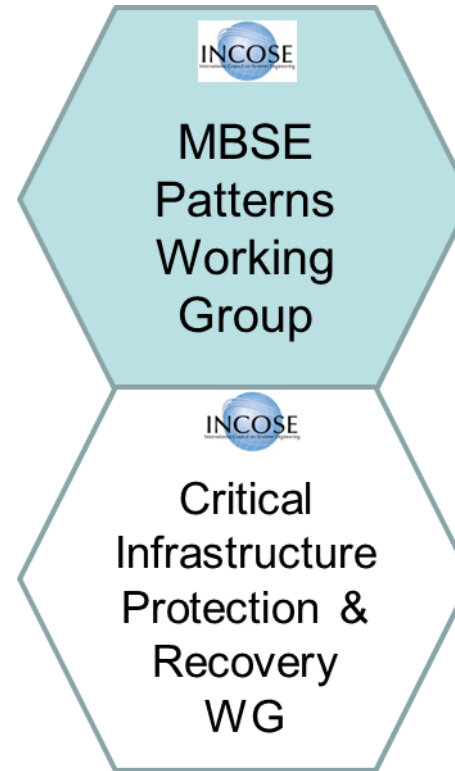

Primary Contact:
Mike DeLamar,
Bechtel

S*Patterns for Critical Infrastructure, Electrical Power,
Common Recovery Model; including ASELCM Systems 1, 2, 3



Emergence of Patterns from Patterns: S*Pattern Class Hierarchy

More General

Definition of **Relational Modeling Paradigm**

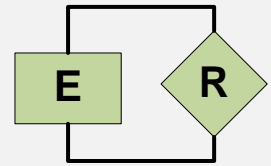

E=Entity
R= Relationship

Structured or unstructured semantic web

Minimal System S*Metamodel:
Definition of (Elementary) System, Material Cause

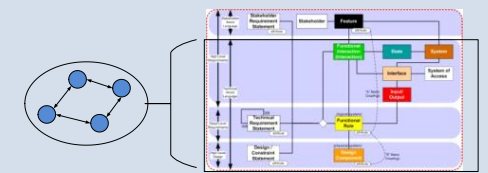
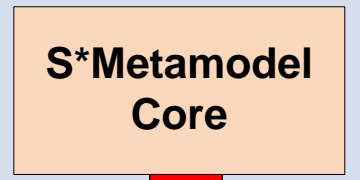

Core S*Metamodel

Smallest model of a system, for engineering or science

Emergence & Definition of **System of Innovation**, Fitness, Value, Purpose, Stakeholders, Agility, Final Cause, Formal Cause, Efficient Cause, Intelligence, Management, Science, Living Systems



S*Purpose, Fitness, Value

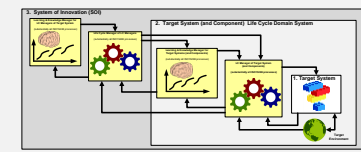
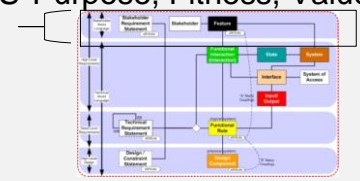

Agile Sys Life Cycle Pattern

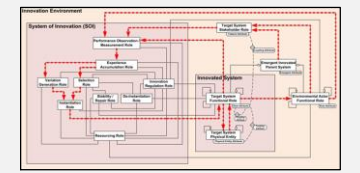

System of Innovation Pattern

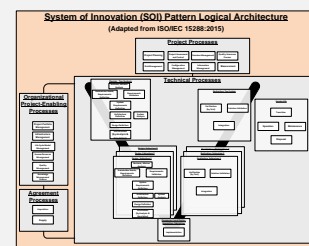

ISO 15288 System Life Cycle Mgmt Pattern

Emergence & Definition of **Domain Specific Systems**

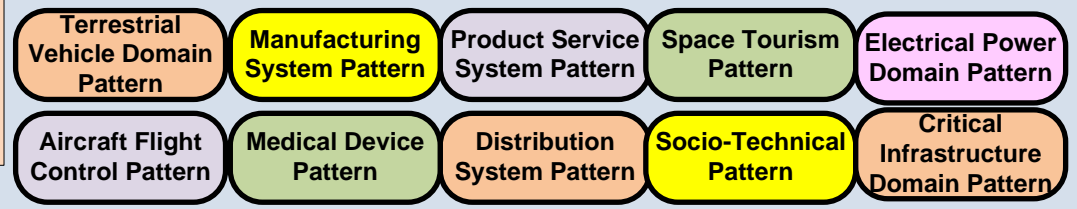
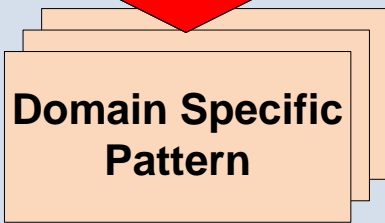

More Specific

Emergence of Patterns from Patterns: S*Pattern Class Hie

More General
↓
More Specific

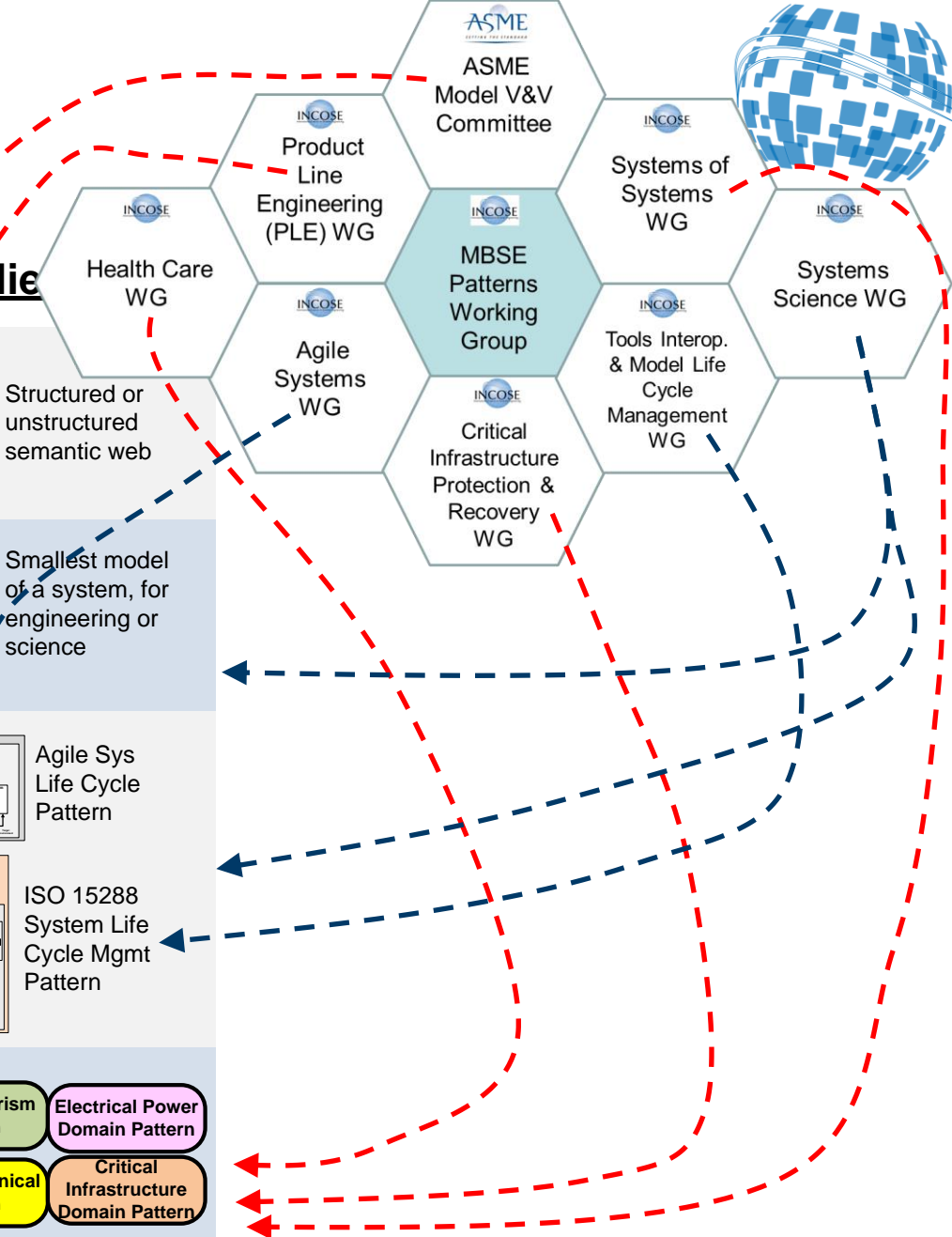
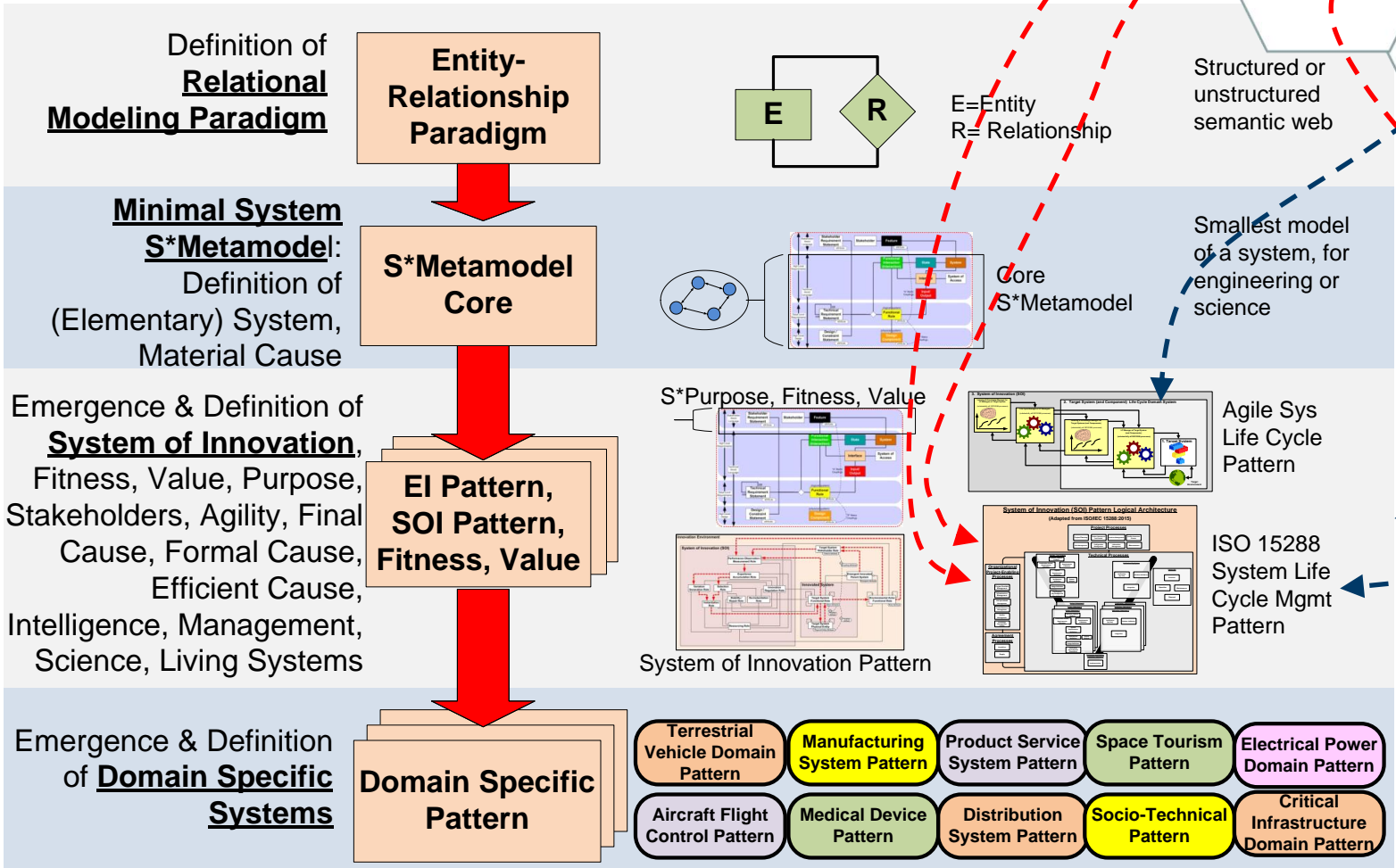

Recent Patterns WG public activities



- INCOSE IS2016 (Jul, 2016)
- ISSS 2016 (Jul, 2016)
- INCOSE Agile Health Care Systems Conferences 2016, 2017
- INCOSE Great Lakes Regional Conference 2016 (Sep, 2016)
- INCOSE Socorro Systems Summit (Oct, 2016)
- INCOSE/IEEE Energy Tech 2016 Conference (Nov, 2016)
- ASME VV 50 Model V&V Standards Committee (2016, 2017 working group meetings, May, 2017 Symposium)
- AIAA Aviation 2017 CASE Session, Denver (June, 2017)
- MBSE Symposium, No Magic, Inc. (May, 2017)



Summary of Patterns WG activities at IS2017:

- Patterns WG meeting slots and related events on Sun, Mon, Tues (Jul 15-17):
 - Reports and work with joint project partner Working Groups
- Additional meetings with “partner” Working Groups during their IW meetings
- Support for related (CAB on MBSE Transformation, etc.) IS activities.

PBSE-related papers at IS2017:

- IS2017 Best Paper, co-authored with Rick Dove: “Case Study: Agile SE Process for Centralized SoS Sustainment at Northrop Grumman” (uses ASELCM Pattern; Monday, Track 4, 1000–1210)
- “Innovation, Risk, Agility, and Learning, Viewed as Optimal Control & Estimation” (Wednesday, Track 3, 1330-1455)

Details of agenda . . .

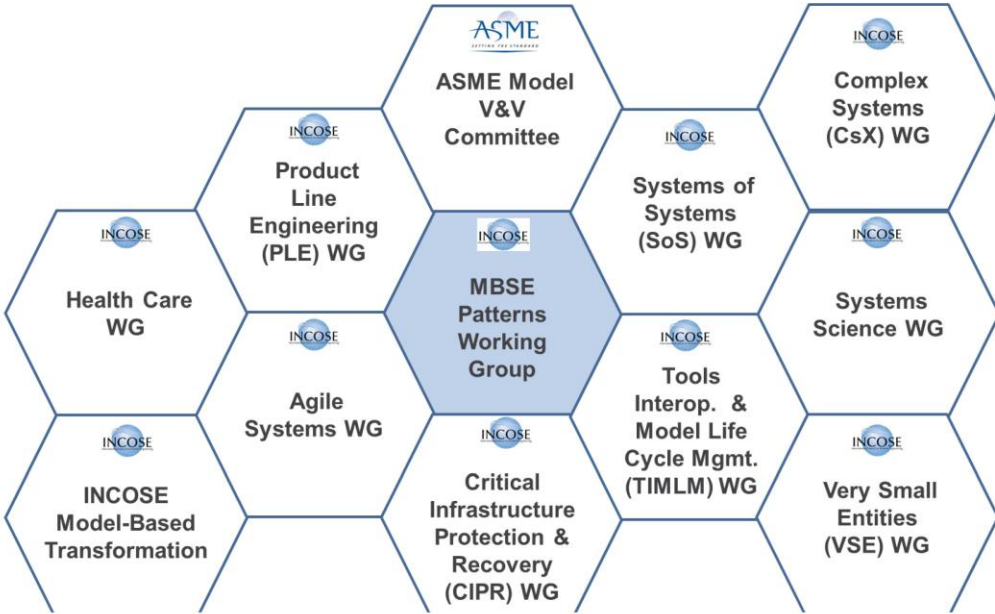

<u>Agenda, Partner Events of Interest: INCOSE MBSE Patterns Working Group, at IS2017, and Web Conferencing</u>	<u>Local Australian Central Daylight Time (ACDT) (=USET+13.5 Hrs)</u>	<u>Meeting Room at IS2017</u>	<u>Global Meet Access?</u>
<p data-bbox="522 301 986 439" style="text-align: center;"><u>MBSE Patterns WG:</u> <u>Joint IS2017 activities,</u> <u>interests, project partners</u></p> 			
<p data-bbox="471 858 986 886"><u>Patterns WG Pre-reading and Background:</u></p> <p data-bbox="522 893 1380 922">Meeting events and materials for activities of the MBSE Patterns WG at IS2017:</p> <p data-bbox="548 925 1676 953">http://www.omgwiki.org/MBSE/doku.php?id=mbse:patterns:patterns_challenge_team_mtg_07.15-17.17</p> <p data-bbox="522 956 1221 985">Minutes of previous meeting of the WG---Jan, 2017, at IW2017:</p> <p data-bbox="548 988 1676 1016">http://www.omgwiki.org/MBSE/doku.php?id=mbse:patterns:patterns_challenge_team_mtg_01.28-31.17</p> <p data-bbox="522 1019 1020 1048">INCOSE WG web site for MBSE Patterns WG:</p> <p data-bbox="548 1051 1530 1079">http://www.incose.org/ChaptersGroups/WorkingGroups/Transformational/mbse-patterns</p> <p data-bbox="522 1082 896 1110">WG INCOSE/OMG mbse wiki site:</p> <p data-bbox="548 1113 1313 1142">http://www.omgwiki.org/MBSE/doku.php?id=mbse:patterns:patterns</p> <p data-bbox="522 1145 834 1173">MBSE Patterns WG Charter:</p> <p data-bbox="548 1176 2068 1205">http://www.incose.org/docs/default-source/Working-Groups/MBSE-Patterns-WG/mbse-patterns-wg-re-charter-2016-incose-approved-v2-2-1.pdf?sfvrsn=2</p> <p data-bbox="522 1219 1097 1248">PBSE Methodology Summary from the Patterns WG:</p> <p data-bbox="548 1250 1174 1279">http://www.omgwiki.org/MBSE/doku.php?id=mbse:pbse</p>			



<u>Agenda, Partner Events of Interest: INCOSE MBSE Patterns Working Group, at IS2017, and Web Conferencing</u>	<u>Local Australian Central Daylight Time (ACDT) (=USET+13.5 Hrs)</u>	<u>Meeting Room at IS2017</u>	<u>Global Meet Access?</u>
<p><u>MBSE Patterns WG General Meeting 1:</u></p> <p>Introductions, brief review of WG’s mission and agenda for IS2017 Summary of Patterns WG activities in progress and since last (IW2017) general meeting</p> <p>Current Projects: <i>(times when joint projects covered in depth depends on partner WG availability)</i></p> <ul style="list-style-type: none"> ○ Interface Patterns Project (Project Team Salvatore, Torok, Sherey, Lewis, Schindel) ○ Legacy Product Line Pattern Harvest by Pattern Projections (Joint with PLE WG) ○ Collaborative Innovation Ecosystem (Joint with TIMLM and PLE WGs) ○ VVUQ for Models (Joint with ASME VV50 Stds Cmtee, Project Team Shao, Hightower, Schindel) ○ Critical Infrastructure Pattern & Electr. Grid Specialization (Joint w CIPR & Pwr/Energy WGs) ○ INCOSE MB Transformation Assets (Joint with Transformation Lead Team, Peterson, et al) ○ INCOSE Agile Health Care Systems Conference, (Joint with Health Care WG) ○ Basis for a Systems Science (Joint with System Science WG) ○ Agile Systems Engineering Life Cycle Model Discovery Project (joint with Agile SE WG) ○ S*Pattern Expression of SoS Patterns (joint with SoS WG) <p>Prospective Projects, Interests: <i>(times of discussions in depth depend on partner WG availability)</i></p> <ul style="list-style-type: none"> ○ Patterns in Complex Systems (Joint with Complex Systems WG) ○ S*Pattern Expression in VSE Patterns (Joint with VSE WG) ○ S*Patterns Expression in Manufacturing and Logistics Systems (Joint with Challenge Team) ○ Other Future Activities and Issues of Interest to Attendees 	<p>Saturday, July 15 13:30-16:30</p>	<p>Patterns WG Mtg Room: <u>City Rm 4</u></p>	<p>Yes</p>
<p><u>MBSE Patterns WG: Other meetings during Partners WG Meetings scheduled this day:</u></p>	<p>Saturday, July 15</p>	<p>Partner WG Mtg Rms: -- -- --</p>	



<u>Agenda, Partner Events of Interest: INCOSE MBSE Patterns Working Group, at IS2017, and Web Conferencing</u>	<u>Local Australian Central Daylight Time (ACDT) (=USET+13.5 Hrs)</u>	<u>Meeting Room at IS2017</u>	<u>Global Meet Access?</u>
<p><u>MBSE Patterns WG General Meeting 2:</u></p> <p>Introductions, brief review of WG’s mission and agenda for IS2017 Summary of Patterns WG activities in progress and since last (IW2017) general meeting</p> <p>Current Projects: <i>(times when joint projects covered in depth depends on partner WG availability)</i></p> <ul style="list-style-type: none"> ○ Interface Patterns Project (Project Team Salvatore, Torok, Sherey, Lewis, Schindel) ○ Legacy Product Line Pattern Harvest by Pattern Projections (Joint with PLE WG) ○ Collaborative Innovation Ecosystem (Joint with TIMLM and PLE WGs) ○ VVUQ for Models (Joint with ASME VV50 Stds Cmtee, Project Team Shao, Hightower, Schindel) ○ Critical Infrastructure Pattern & Electr. Grid Specialization (Joint w CIPR & Pwr/Energy WGs) ○ INCOSE MB Transformation Assets (Joint with Transformation Lead Team, Peterson, et al) ○ INCOSE Agile Health Care Systems Conference, (Joint with Health Care WG) ○ Basis for a Systems Science (Joint with System Science WG) ○ Agile Systems Engineering Life Cycle Model Discovery Project (joint with Agile SE WG) ○ S*Pattern Expression of SoS Patterns (joint with SoS WG) <p>Prospective Projects, Interests: <i>(times of discussions in depth depend on partner WG availability)</i></p> <ul style="list-style-type: none"> ○ Patterns in Complex Systems (Joint with Complex Systems WG) ○ S*Pattern Expression in VSE Patterns (Joint with VSE WG) ○ S*Patterns Expression in Manufacturing and Logistics Systems (Joint with Challenge Team) ○ Other Future Activities and Issues of Interest to Attendees 	<p>Sunday, July 16 13:30-16:30</p>	<p>Patterns WG Mtg Room: <u>City Rm 4</u></p>	<p>Yes</p>
<p><u>MBSE Patterns WG: Other meetings with and during Partners WG Meetings scheduled this day:</u></p>	<p>Sunday, July 16 13:30-16:30</p>	<p>Partner WG Mtg Rms: -- --</p>	



<u>Agenda, Partner Events of Interest: INCOSE MBSE Patterns Working Group, at IS2017, and Web Conferencing</u>	<u>Local Australian Central Daylight Time (ACDT) (=USET+13.5 Hrs)</u>	<u>Meeting Room at IS2017</u>	<u>Global Meet Access?</u>
		--	
<p><u>MBSE Patterns WG General Meeting 3:</u> Introductions, brief review of WG’s mission and agenda for IS2017 Summary of Patterns WG activities in progress and since last (IW2017) general meeting Current Projects: <i>(times when joint projects covered in depth depends on partner WG availability)</i></p> <ul style="list-style-type: none"> ○ Interface Patterns Project (Project Team Salvatore, Torok, Sherey, Lewis, Schindel) ○ Legacy Product Line Pattern Harvest by Pattern Projections (Joint with PLE WG) ○ Collaborative Innovation Ecosystem (Joint with TIMLM and PLE WGs) ○ VVUQ for Models (Joint with ASME VV50 Stds Cmtee, Project Team Shao, Hightower, Schindel) ○ Critical Infrastructure Pattern & Electr. Grid Specialization (Joint w CIPR & Pwr/Energy WGs) ○ INCOSE MB Transformation Assets (Joint with Transformation Lead Team, Peterson, et al) ○ INCOSE Agile Health Care Systems Conference, (Joint with Health Care WG) ○ Basis for a Systems Science (Joint with System Science WG) ○ Agile Systems Engineering Life Cycle Model Discovery Project (joint with Agile SE WG) ○ S*Pattern Expression of SoS Patterns (joint with SoS WG) <p>Prospective Projects, Interests: <i>(times of discussions in depth depend on partner WG availability)</i></p> <ul style="list-style-type: none"> ○ Patterns in Complex Systems (Joint with Complex Systems WG) ○ S*Pattern Expression in VSE Patterns (Joint with VSE WG) ○ S*Patterns Expression in Manufacturing and Logistics Systems (Joint with Challenge Team) ○ Other Future Activities and Issues of Interest to Attendees 	<p>Mon, July 17 15:30-17:00</p>	<p>Patterns WG Mtg Room: <u>City Rm 4</u></p>	<p>Yes</p>
<p><u>MBSE Patterns WG: Other meetings with and during Partners WG Meetings scheduled this day:</u></p>	<p>Mon, July 17</p>		
<p><u>MBSE Patterns WG: Other meetings with and during Partners WG Meetings scheduled this day:</u></p>	<p>Tues, July 18</p>		
<p><u>MBSE Patterns WG: Other meetings with and during Partners WG Meetings scheduled this day:</u></p>	<p>Wed, July 19</p>		
<p><u>MBSE Patterns WG: Other meetings with and during Partners WG Meetings scheduled this day:</u></p>	<p>Thurs, July 20</p>		

For more information, contact-- **MBSE Patterns WG:** Bill Schindel schindel@icct.com Troy Peterson tpeterson@systemxi.com

Current project example: Interface Patterns Project

INCOSE MBSE Patterns Working Group

Project Charter

1 Project Name:

The name of the project is the MBSE Interface Patterns Project.

2 Project Objectives and Summary:

The objectives of project are to:

- 1) Improve shared knowledge and more effective life cycle engineering of Interface-related aspects of systems, through the definition and use of Interface-related MBSE Patterns.
- 2) Make available S*Patterns related to Interfaces, expressing common configurable modeled aspects of systems, at different levels of abstraction:
 - a. Most abstract: The S* Interface Pattern for all interfaces (S*Metamodel level)
 - b. Domain specific or technology specific S* Interface Patterns
 - c. Organized into a library illustrating the propagation upward and downward of modeled aspects at different levels of abstraction/specificity
 - d. Suitable for use and support of targeted life cycle tasks (e.g., generation of Interface Control Documents, etc.)
 - e. Suitable as guiding examples for other domains or technologies not directly addressed
- 3) Consistent with the Patterns Working Group precepts of:
 - a. Seeking the simplest model representations necessary for practical use in targeted domains, having differing demand levels and expectations
 - b. Maintaining portability and mappings across different modeling languages, tools, and information systems, as these continue to mature and evolve, and demonstrating that capability
 - c. MBSE Patterns must be PBSE configurable for specific instances
 - d. Interface Patterns should connect to the larger System Pattern representation that is the scope of the Patterns Working Group
- 4) Informed by the history of interface engineering across domains, the perceived current and future needs and priorities of the engineering community, and related efforts underway across different INCOSE and external working groups, standards bodies, trade groups, enterprises and institutions, and other communities of interest.

3 Project Deliverables:

- 1) General S* Interface Pattern (S*Metamodel level)
- 2) Targeted domain specific or technology specific S* Interface Patterns, to be identified
- 3) Library organization of these patterns, based large scale pattern structures to be explored
- 4) Demonstrations on targeted toolsets, modeling languages, and information systems, including generation of targeted priority views, documents, or extracts useful in the system life cycle
- 5) Joint deliverables with other working group projects (e.g., the Innovation Collaboration Ecology Demonstration Project)
- 6) Specific interface examples and teaching or educational materials.
- 7) Means of access to the Deliverables.

4 Project Team:

Jonathan Torok, NSWC Crane, jonathan.torok@navy.mil

Frank Desalvo, Engility Corp., Frank.Salvatore@engilitycorp.com

Jason Sherey, ICTT System Sciences, sherey@icct.com

Bill Schindel, ICTT System Sciences, schindel@icct.com

5 Project Schedule:

Schedule, including meetings, milestones, and overall is to be determined by the team. It is suggested that key milestones include INCOSE IS and IW events, along with regular periodic meetings and deliverables.

6 Project References:

Project web site:

http://www.omgwiki.org/MBSE/doku.php?id=mbse:patterns:interface_patterns_team#interface_patterns_team

See other references listed on the project web site.

Current project example: Interface Patterns Project

INCOSE MBSE Patterns Working Group

3 Project Deliverables:

- 1) General S*Interface Pattern (S*Metamodel level)

4) Informed by the history of interface engineering across domains, the perceived current and future needs and priorities of the engineering community, and related efforts underway across different INCOSE and external working groups, standards bodies, trade groups, enterprises and institutions, and other communities of interest.

- of systems, through the definition and use of Interface-related MBSE Patterns.
- 2) Make available S*Patterns related to Interfaces, expressing common configurable modeled aspects of systems, at different levels of abstraction:
 - a. Most abstract: The S*Interface Pattern for all interfaces (S*Metamodel level)
 - b. Domain specific or technology specific S*Interface Patterns
 - c. Organized into a library illustrating the propagation upward and downward of modeled aspects at different levels of abstraction/specificity
 - d. Suitable for use and support of targeted life cycle tasks (e.g., generation of Interface Control Documents, etc.)
 - e. Suitable as guiding examples for other domains or technologies not directly addressed
- 3) Consistent with the Patterns Working Group precepts of:
 - a. Seeking the simplest model representations necessary for practical use in targeted domains, having differing demand levels and expectations
 - b. Maintaining portability and mappings across different modeling languages, tools, and information systems, as these continue to mature and evolve, and demonstrating that capability
 - c. MBSE Patterns must be PBSE configurable for specific instances
 - d. Interface Patterns should connect to the larger System Pattern representation that is the scope of the Patterns Working Group

4) Informed by the history of interface engineering across domains, the perceived current and future needs and priorities of the engineering community, and related efforts underway across different INCOSE and external working groups, standards bodies, trade groups, enterprises and institutions, and other communities of interest.

Jonathan Torok, NSWC Crane, Jonathan.Torok@navy.mil
Frank Desalvo, Engility Corp., Frank.Salvatore@engilitycorp.com
Jason Sherey, ICTT System Sciences, sherey@ictt.com
Bill Schindel, ICTT System Sciences, schindel@ictt.com

5 Project Schedule:

Schedule, including meetings, milestones, and overall is to be determined by the team. It is suggested that key milestones include INCOSE IS and IW events, along with regular periodic meetings and deliverables.

6 Project References:

Project web site:
http://www.omgwiki.org/MBSE/doku.php?id=mbse:patterns:interface_patterns_team:interface_patterns_team
See other references listed on the project web site.

We are interoperating with the OMG SysML 2.0 effort, among others

Current project example: Interface Patterns Project

Project Workstreams:

1. Identify interface aspects of the S*Metamodel (the most abstract interface pattern)
2. Create library of interface patterns of different types (specializations of 1) showing techniques in mechanical, communication, visual, etc.
3. Identify queries and views that are interface-based (e.g., ICD, etc.), what metadata should appear in each of these.
4. Identify interface-oriented tasks, activities in the engineering life cycle (the reasons we are doing this project)
5. Down the road, issues of governance of the resulting patterns, their life cycles
6. Tactical level tool specific items, not necessarily all interface-oriented, along with mappings to SysML or specific tools

Discussion of S*Interface System of Access (SOA) Semantics

Interface Patterns Project Meeting

06.30.2017

Purpose of Following Material

1. The purpose of this material is to define a question, and propose an answer to it, concerning the underlying nature and meaning of one aspect of Interfaces.
2. This subject is about the underlying nature of interfaces, and not about any specific modeling language or notation.
3. This discussion therefore uses some basic concepts from the S*Metamodel description of Interfaces, not specific to any modeling language, notation, etc.
4. If we agree on the question and answer proposed here, then a follow-up action would be to agree on how to map it into SysML representation.
5. Trying to answer (4) before (1) – (3) seems to lead to confusion of what are the underlying issues versus language-specific representation issues.

General Setting

- Consider two interacting systems, exchanging at least one Input-Output (e.g., a Force, Energy Flow, Mass Flow, or Information), during Interaction D:

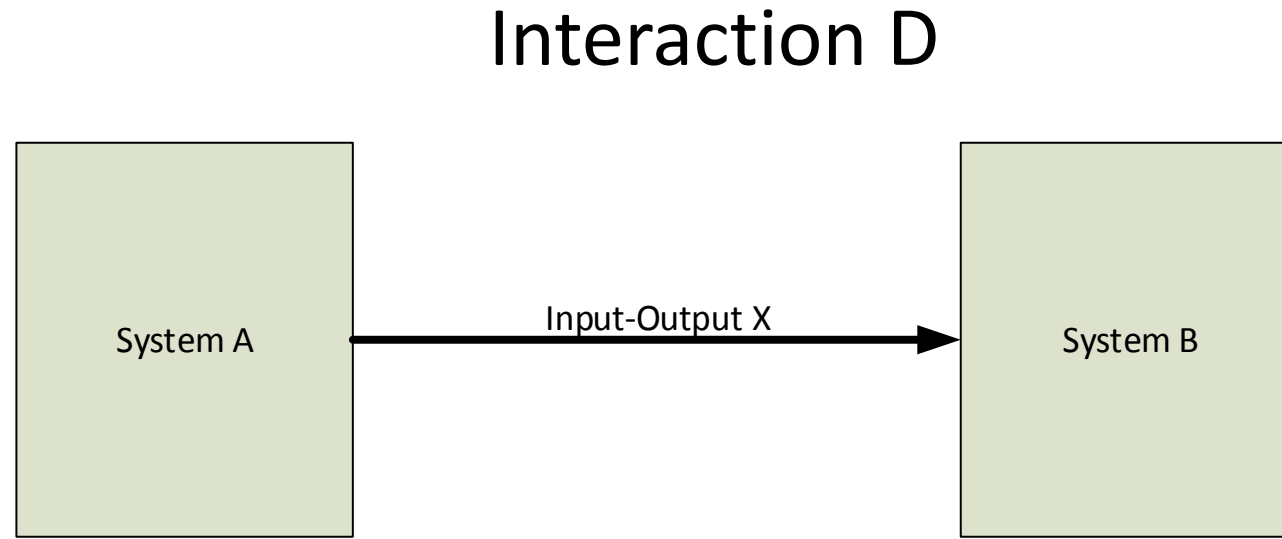

Figure 1: (Exact notation used not important to this discussion)

- In certain (important to identify) circumstances, we need to represent Interfaces involved in Interaction D.
- No matter what (graphical or other) modeling language or notation is used, the S*Metamodel tells us that an Interface is an association of:
 - A System, which “has” the Interface;
 - A (set of) Input-Output(s), which “pass through” the Interface;
 - A (set of) Interaction(s), which describe “behavior at the Interface;
 - A System of Access (SOA), providing the interaction “medium”:

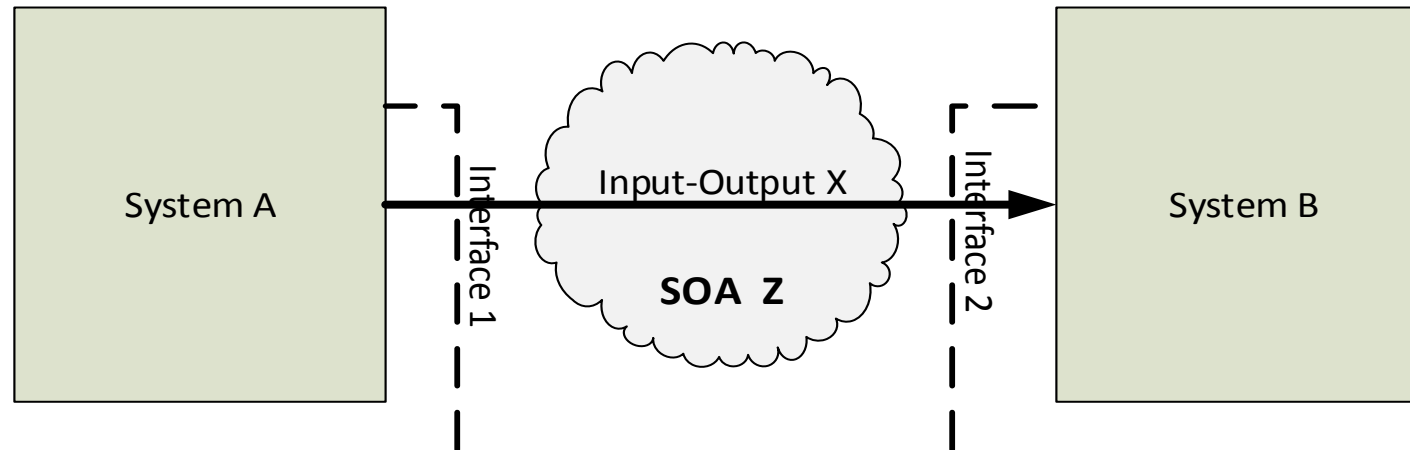

Figure 2: (Exact notation used not important to this discussion)

- However, there is a subtle inconsistency in the transition between Figure 1 and Figure 2 above:
 - Figure 1 and Figure 2 imply that the scope of “System A” must have changed between the two diagrams, . . .
 - Because, System A in Figure 2 can interact with an external-looking SOA Z, but
 - System A in Figure 1 implies that the scope of System A is such that it can interact directly with System B.

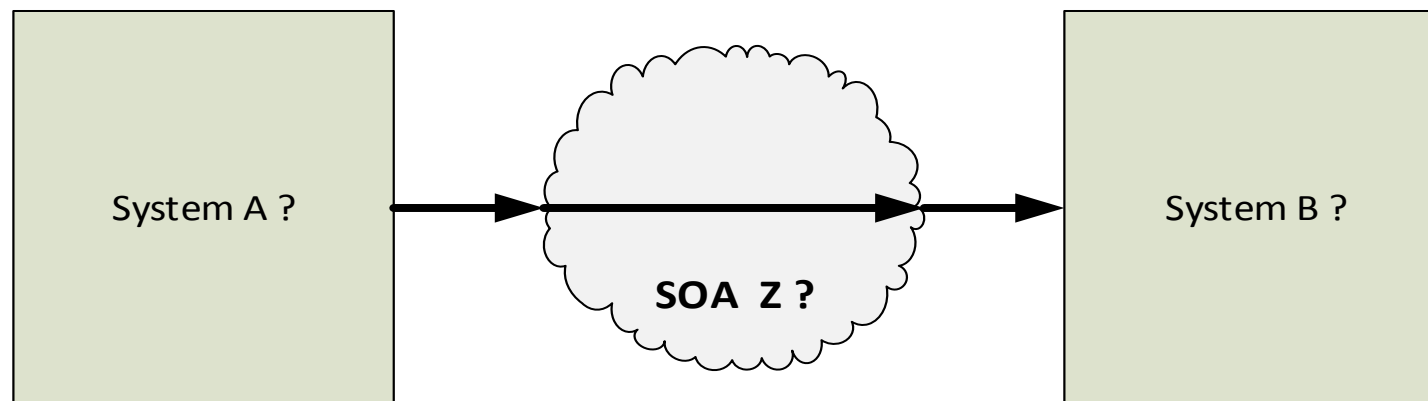

Figure 3: (Exact notation used not important to this discussion)

- The problem here is that even intended “neutral” notations can be specific enough to mislead us, or create ambiguities.
- The real problem is that, independent of notation, the System of Access by definition has larger scope than Figure 2 implied:

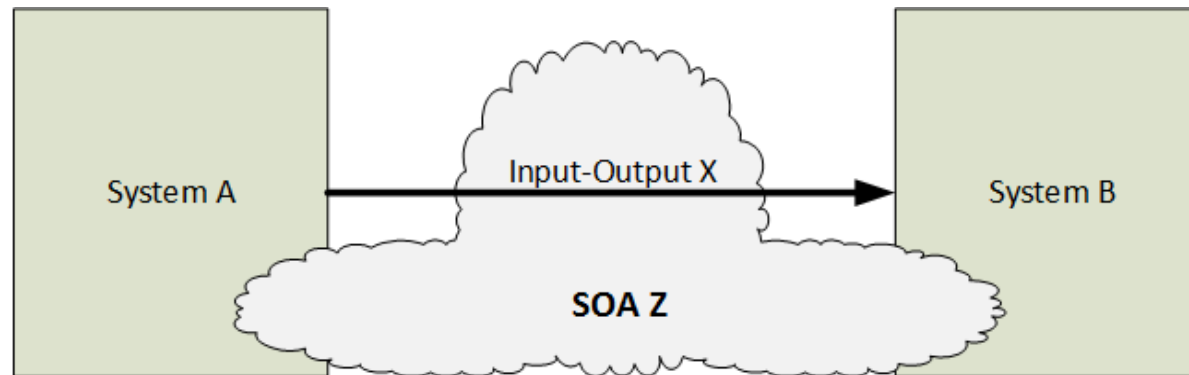

Figure 4: (Exact notation used not important to this discussion)

- Part of the scope of the System of Access for two interacting systems must necessarily be within the two interacting systems . . .

- So, to avoid conflicting or ambiguous definitions of the scope of System A, we have to recognize a slightly larger system, shown in Figure 5 as System A'
- The additional scope adds the SOA role shown here as SASOA:

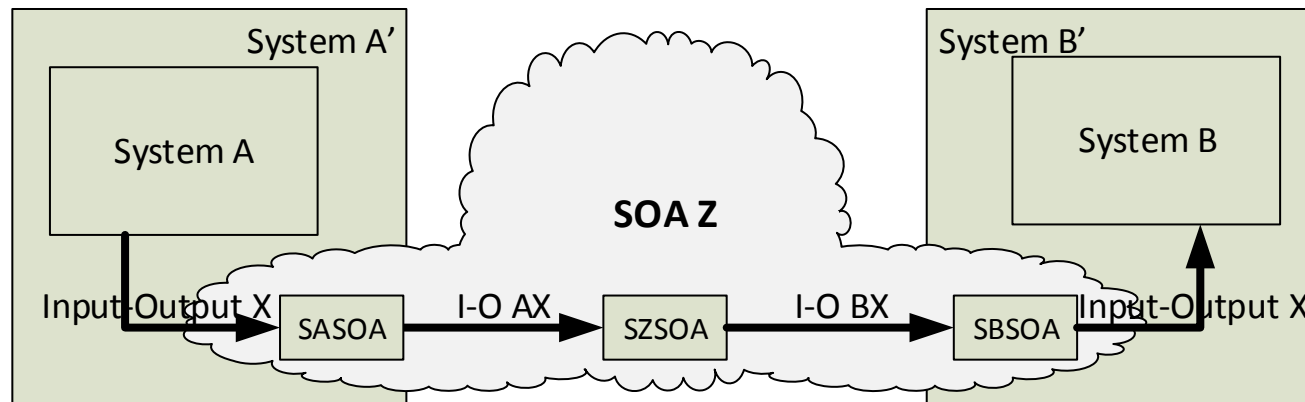

Figure 5: (Exact notation used not important to this discussion)

- The foregoing discussion simply reminds us that any system which we claim “has” an interface must include (inside it) the behavioral (SOA) role(s) necessary to support it (SASOA in Figure 5).
- And, if we model a system that “does not have” any interface (or does not have it “yet”), then we should not (later, or otherwise) see the same system boundary name and claim that it does have an interface—because the behavior boundary is different (System A versus System A’ in Figure 5.)

Implications for any Specific Language

- The above implies that, when we get ready to map to SysML or any specific modeling language/notation:
 - No matter what notation convention is used to show an Interface on a system boundary, applying it must mean that the named system includes the roles to support the interface; and . . .
 - When we show interacting systems that are not shown as having Interfaces, then those named system boundaries should not (even later in a design process) carry the same name as a system boundary that does have an interface.
- That is, System A is not System A':
 - System A' can show an Interface on its boundary (by whatever notational means is selected)
 - System A should not show any Interface on its boundary, but simply be shown as exchanging I/O with System B.

Valid Combinations

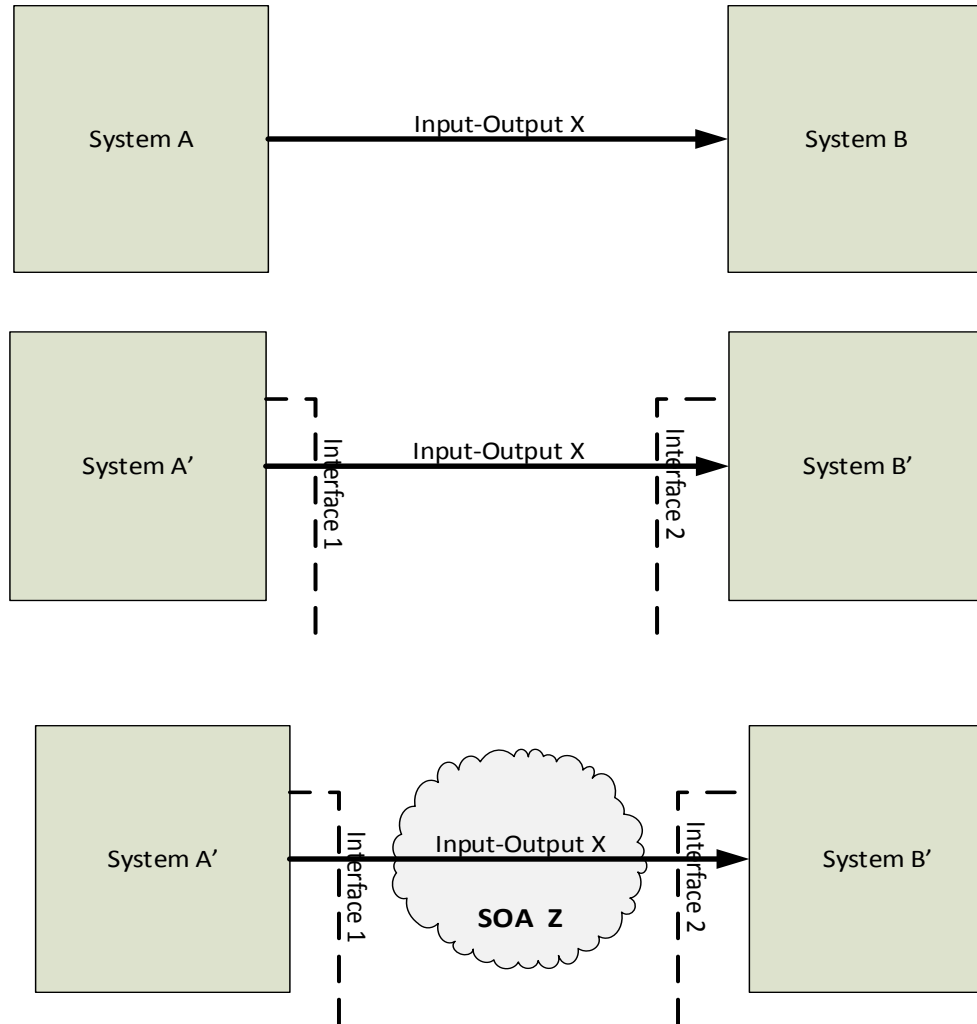

Not Valid Combinations

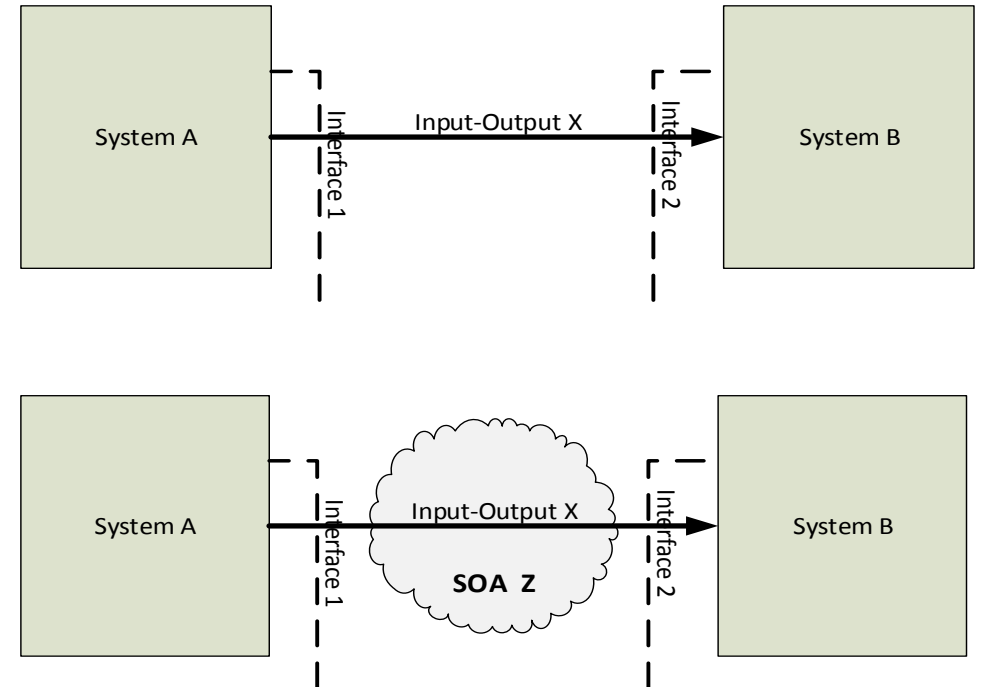

Figure 6: (Exact notation used not important to this discussion)

Do we agree on this?

- More discussion needed?
- If we agree, then let's move on to discussion of what the SysML notation and mapping would be.



Joint activities—detail sections follow

- With Agile SE WG: Joint Activity Materials
- With Product Line Engineering WG: Joint Activity Materials
- With ASME Model V&V Committees: Model V&V Joint Activity Materials
- With SoS WG: Joint Activity Materials
- With Health Care WG: Joint Activity Materials
- With Critical Infrastructure Protection, and Recovery WG: Joint Activity Materials
- With Systems Science WG: Joint Activity Materials
- With Tools Interoperability & Model Life Cycle Mgmt. WG: Joint Activity

With Agile SE WG: Joint Activity Materials



- Agile Systems Engineering Life Cycle Management (ASELCM) Discovery Project: Creating, validating the ASELCM S*Pattern

Primary Contact:
*Rick Dove, Paradigm
Shift, Intl.*

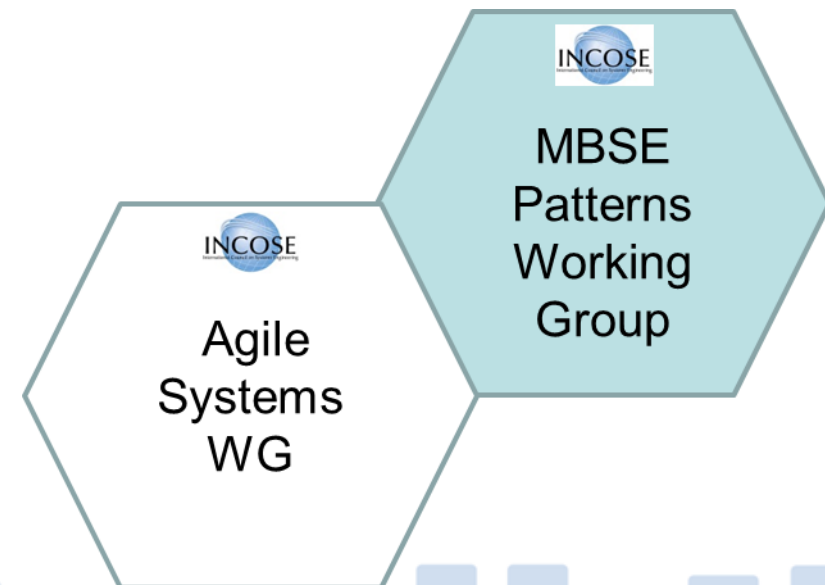

Using the ASELCM Reference Pattern on Four Case Study Sites: Model Highlights



1. Agile Systems Engineering Process Features Collective Culture, Consciousness, and Conscience at SSC Pacific Unmanned Systems Group
2. Transition to Scaled-Agile Systems Engineering at Lockheed Integrated Fighter Group
3. Agile SE Process for Centralized SoS Sustainment at Northrop Grumman (IS2017)
4. Agile Hardware/Firmware/Software Product Line Engineering at Rockwell Collins

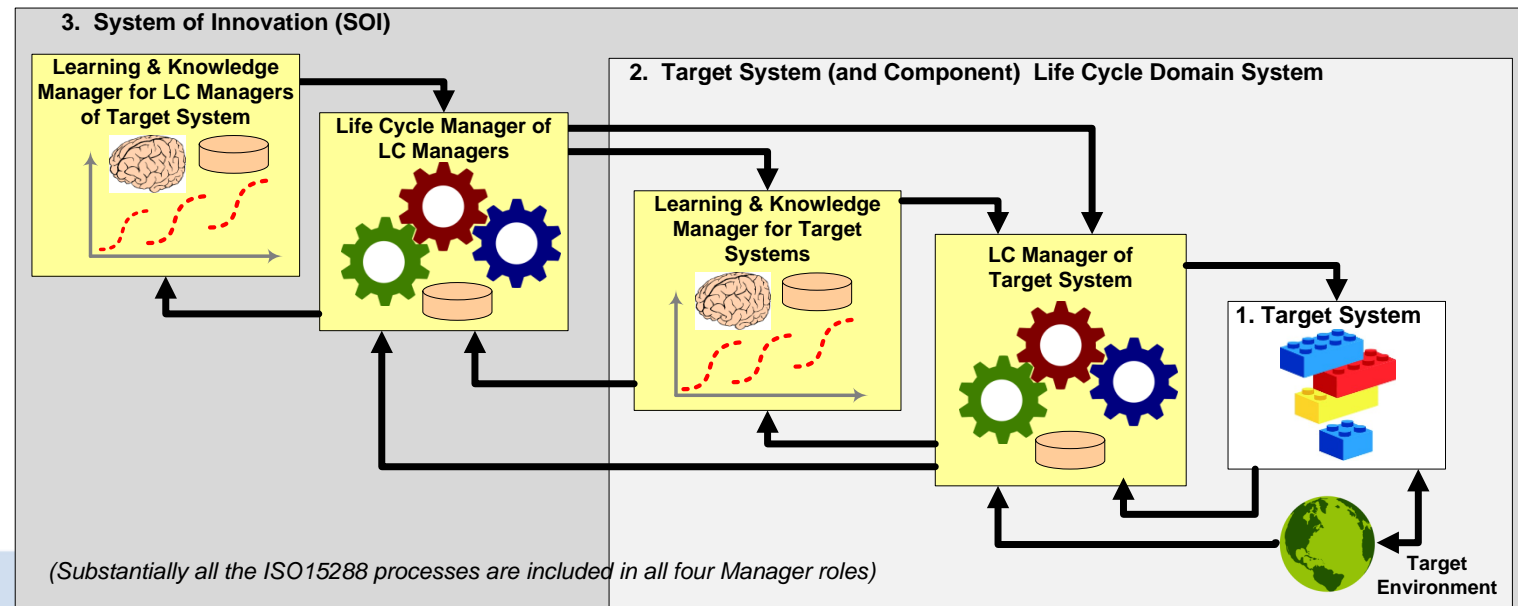

Agile Systems WG Meeting
INCOSE IW17, Jan 30, 2017
Bill Schindel schindel@icct.com



ASELCM Pattern Logical Architecture

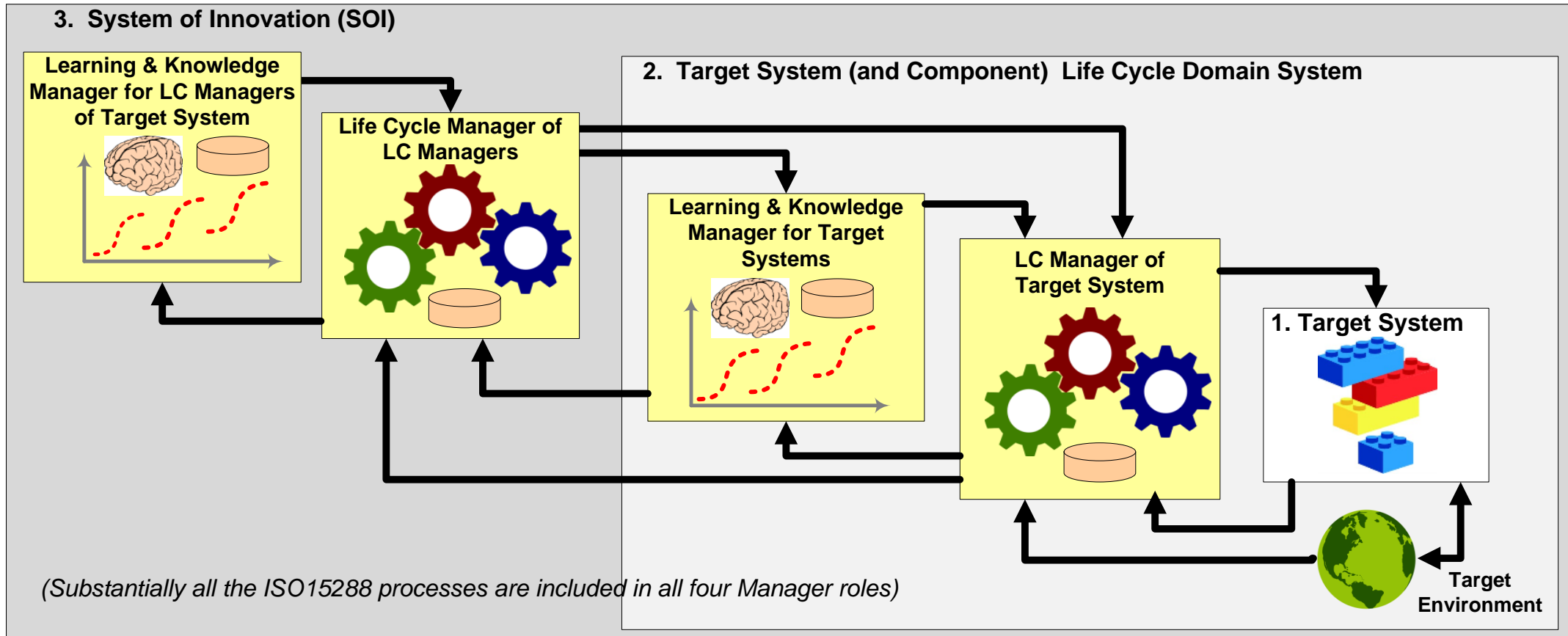

- System 1: Target system of interest, to be engineered or improved.
- System 2: The environment of (interacting with) S1, including all the life cycle management systems of S1, including learning about S1.
- System 3: The life cycle management systems for S2, including learning about S2.



3. System of Innovation (SOI)

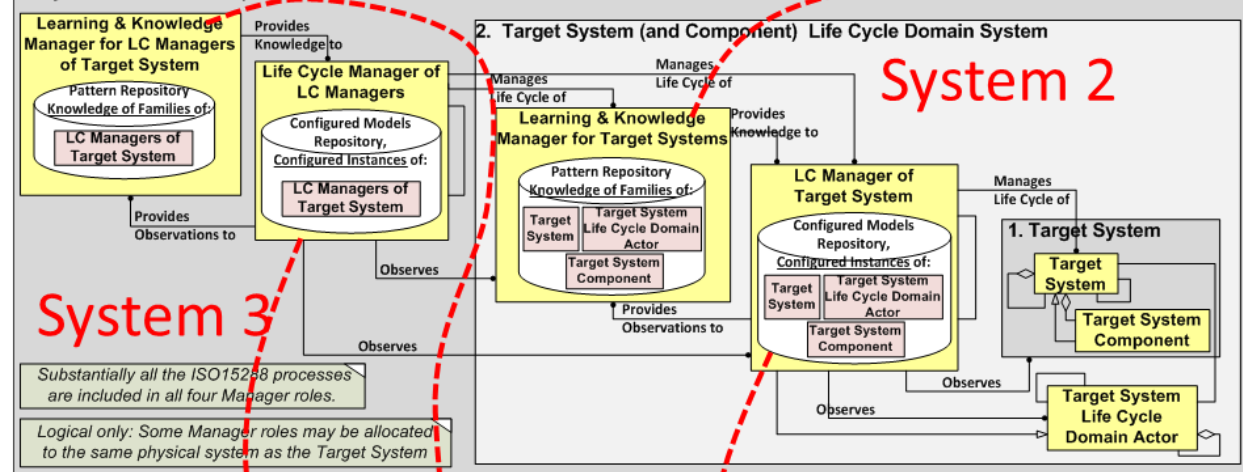

System 3

Substantially all the ISO15288 processes are included in all four Manager roles.
 Logical only: Some Manager roles may be allocated to the same physical system as the Target System

System 2

Performs most of these ISO processes, to manage what is being learned about S1 space.

Performs most of these ISO processes, to manage S1 instances, using S1 patterns

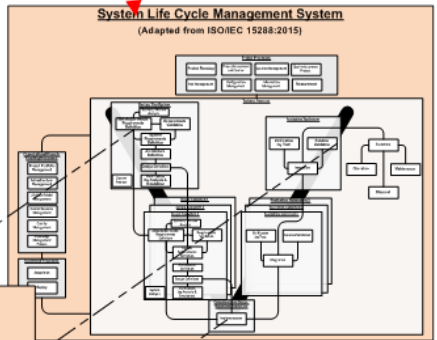

Manages Target System Family Patterns

Manages LC Management System Family Patterns

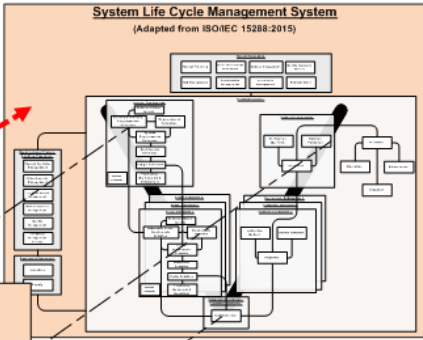

Performs most of these ISO processes, to manage what is being learned about S2 space.

Performs most of these ISO processes, to manage S2 instances, using S2 patterns

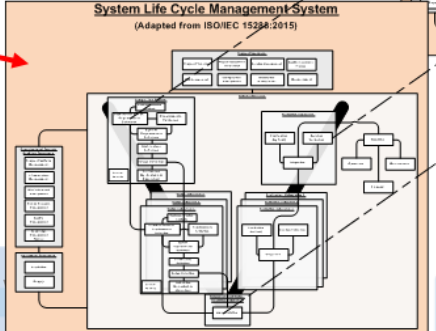

Four "VeEs" in ASELCM

ASELCM Pattern: System 1 (Target System) agility, driven by System 2 (Life Cycle Management) and System 3 (System of Innovation).

Central to the case studies: System 2, 3 Features, Interactions, Roles, Couplings

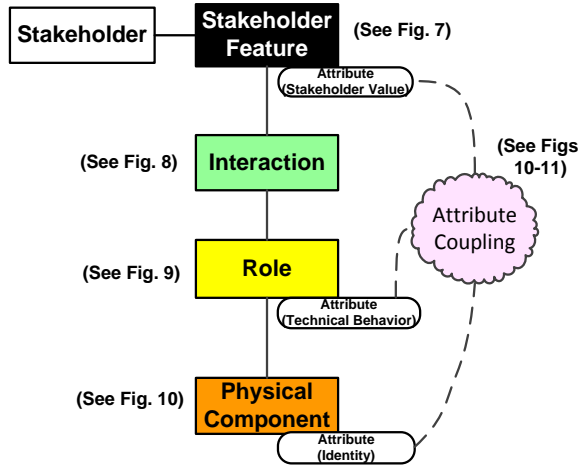

1. Agile Systems Engineering Process Features

Collective Culture, Consciousness, and Conscience

at SSC Pacific Unmanned Systems Group

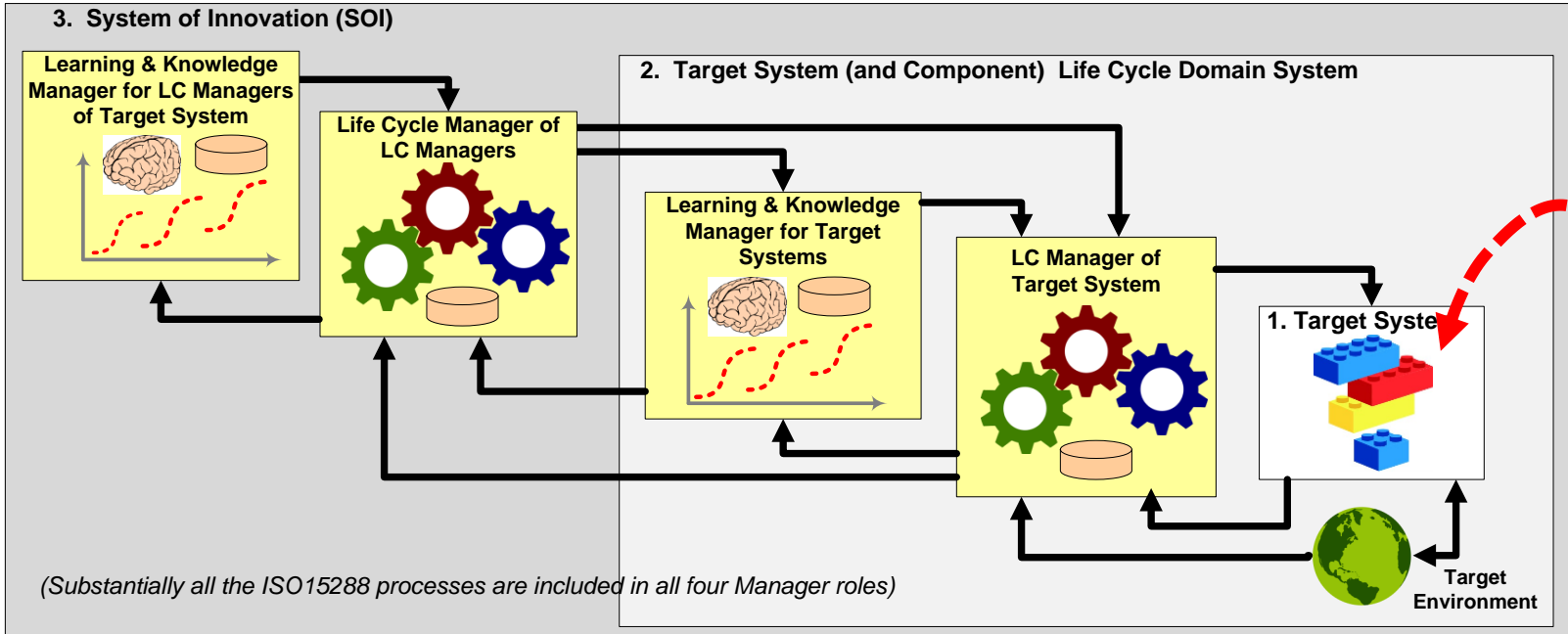

Helped us understand/represent how their approach effectively addresses the “UURVE” environment. In the framework of the ASELCM Pattern, this can be seen as a “System-3 question”



System 2’s “Agile Stakeholder Stories”:

“As a <stakeholder role> I want <system behavior> so that < value statement>.”

- “As a <Sponsor> I want <timely project incorporation of emerging technologies> so that <I obtain a best-in-class autonomous vehicle system>.”
- “As a <Functional Lead> I want <to obtain timely project status> so that <I direct vehicle navigation system development in a timely manner>.”
- “As a <Project Performer> I want to <obtain timely project directional awareness> so that <I contribute responsively to the overall project>.”

Attention Management Feature

ATTN MGMT CAPABILITY
Performance Attribute

Leadership Awareness

Team Condition Awareness
Status Awareness

Team Situational Awareness

Mission Awareness
Status Awareness
Direction Awareness
Team Trust Level
Engagement Level

Proactive Agility Feature

CAPABILITY TYPE
Response Time
Response Cost
Response Effectiveness
Response Predictability
Response Scope

Reactive Agility Feature

CAPABILITY TYPE
Response Time
Response Cost
Response Effectiveness
Response Predictability
Response Scope

Project Outcomes Feature

INCREMENT IDENTITY
Increment Type
Incremental Value
Starting Date
Completion Date
Completion Cost
Financial Risk
Schedule Risk
Performance Risk

Selected Subset of System-2 Stakeholder Features and their Attributes



SPAWAR System Center Pacific (SSC-Pac): Unmanned System Integration, Test, and Experimentation (UxS ITE): Interactions & Emergence --

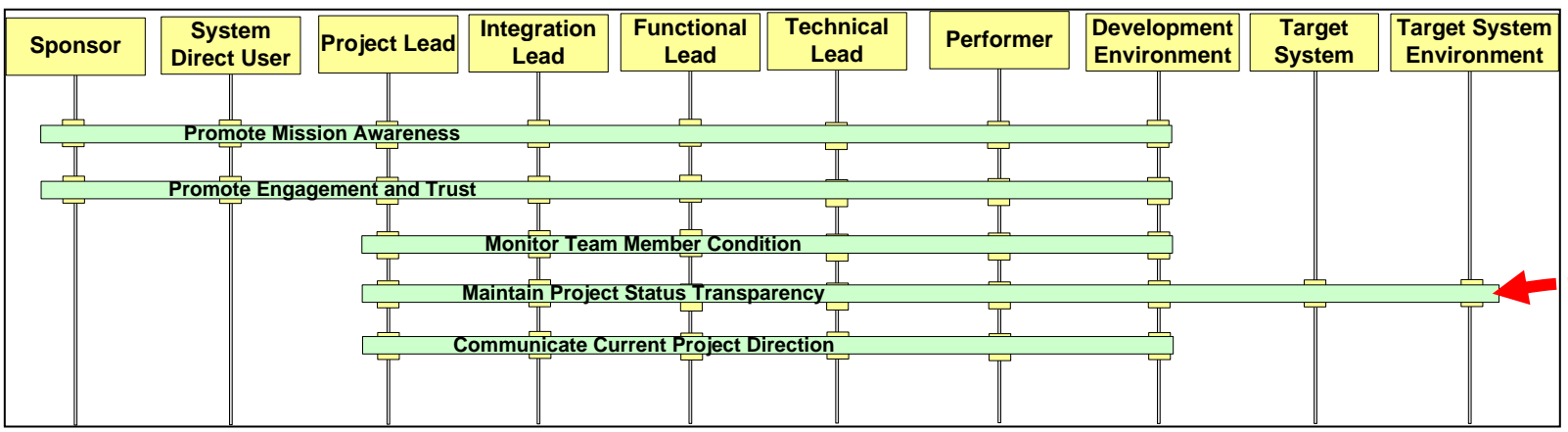

Selected Subset of ASELCM Interactions, System-2

One Interaction

For "Maintain Project Status Transparency" Interaction, Attributes of Individual Component Roles, and Emergent Systemic Attributes

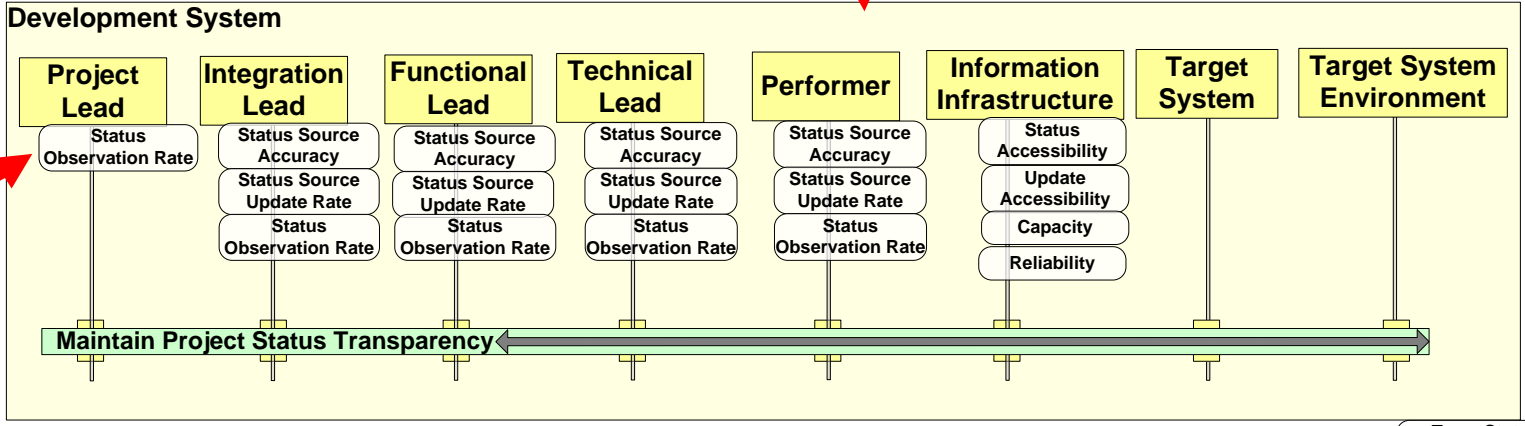

- Team Status Awareness
- Team Status Accuracy
- Team Status Currency



SPAWAR System Center Pacific (SSC-Pac): Unmanned System Integration, Test, and Experimentation (UxSITE) : Attribute Couplings

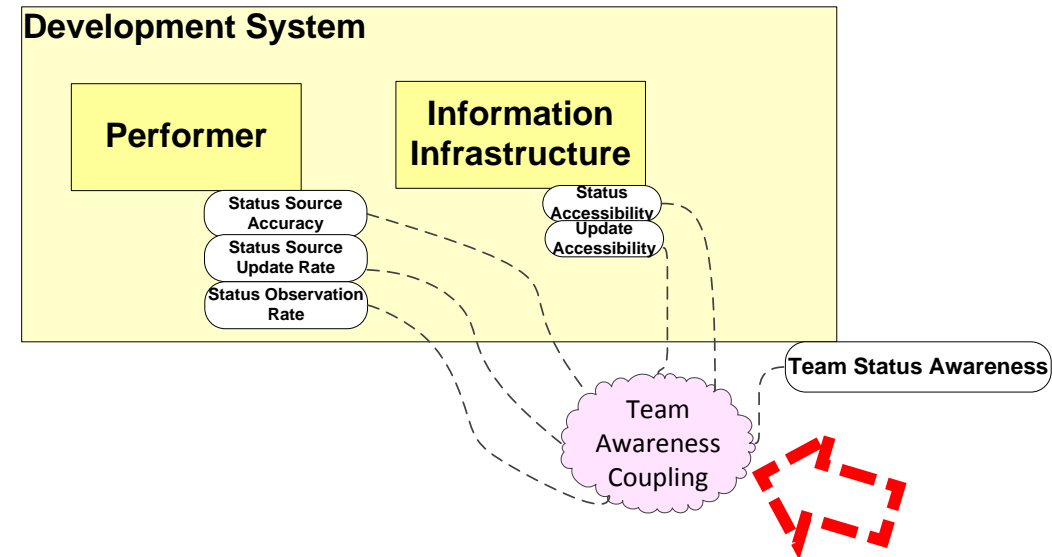
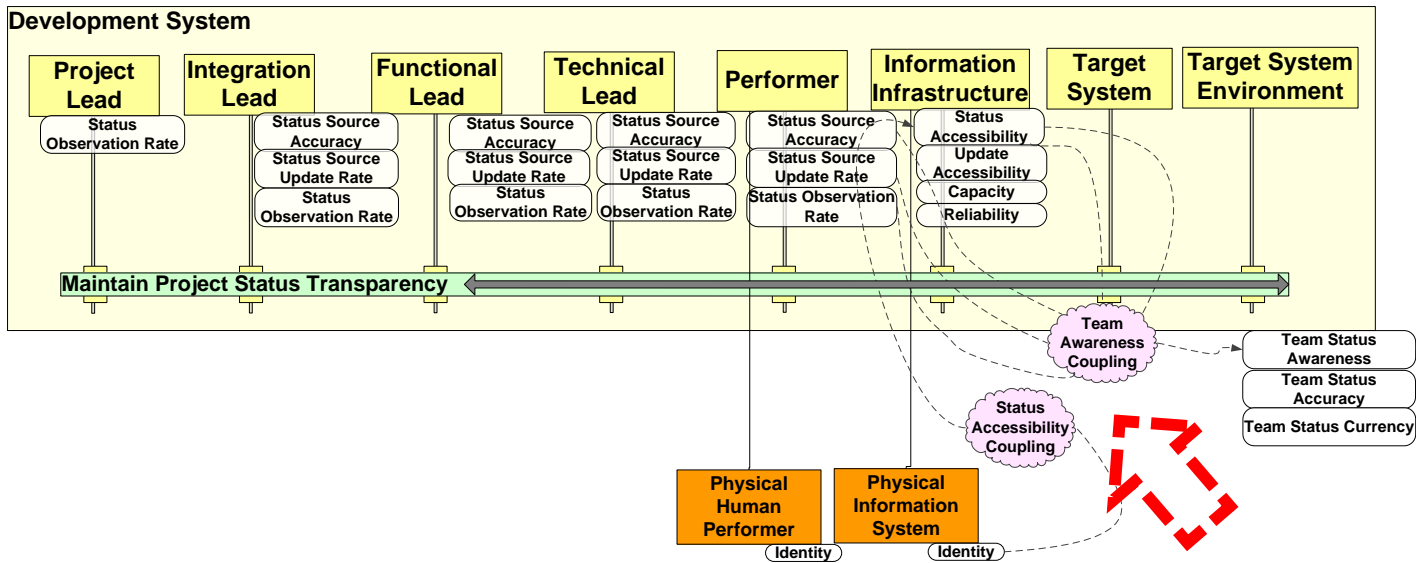
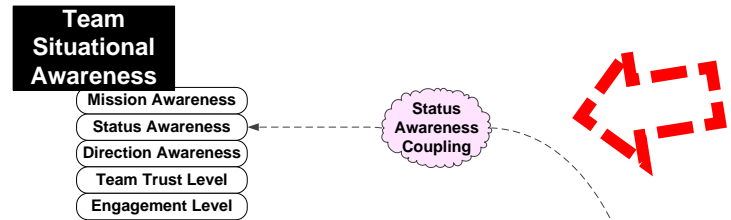

Modeled Parametric Couplings of ASELCM Features, Functional Roles, and Physical Components

Team Status Awareness Arises from Other Attributes



2. Transition to Scaled-Agile Systems Engineering at Lockheed Integrated Fighter Group

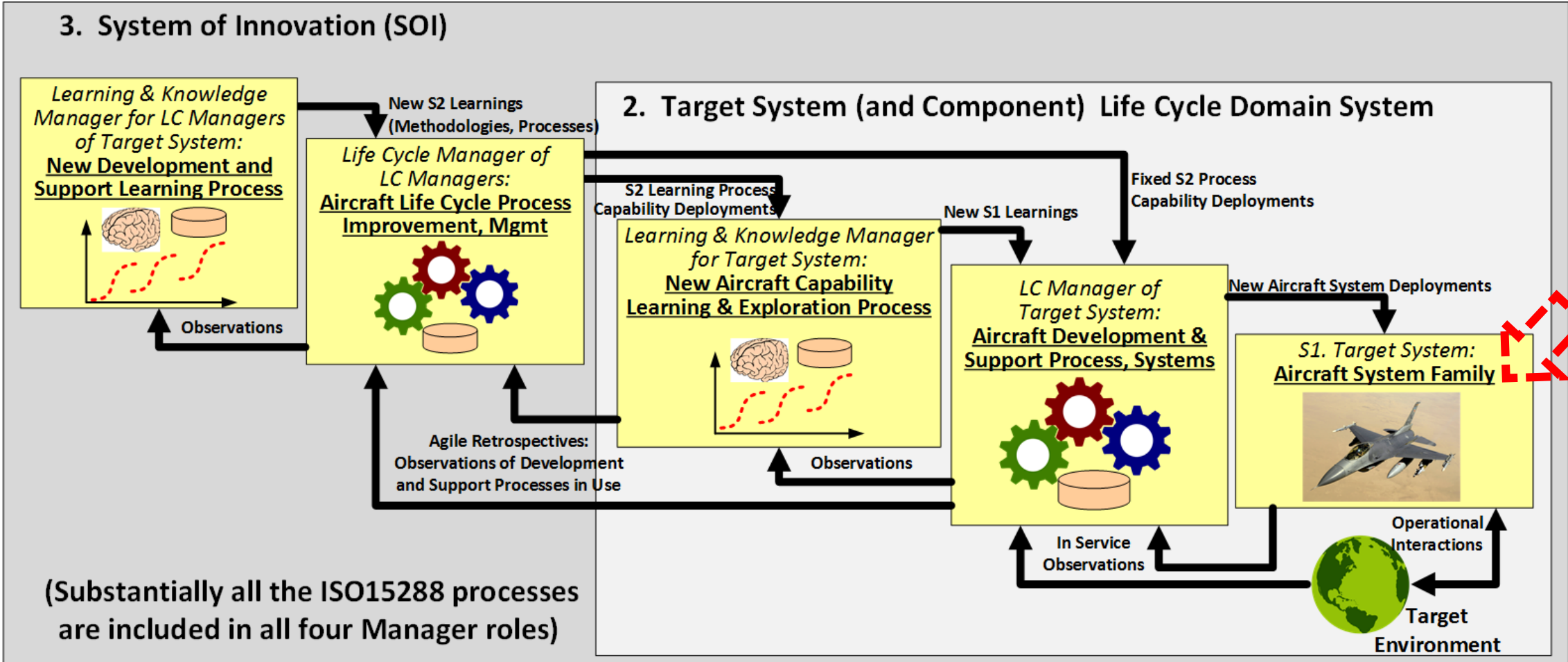



2. Transition to Scaled-Agile Systems Engineering at Lockheed Integrated Fighter Group: Configurations, Costs

Optimal "Flow": smaller batch sizes can result in different configuration trajectories:

Example subspaces:
Reqs, Dsn, Performance

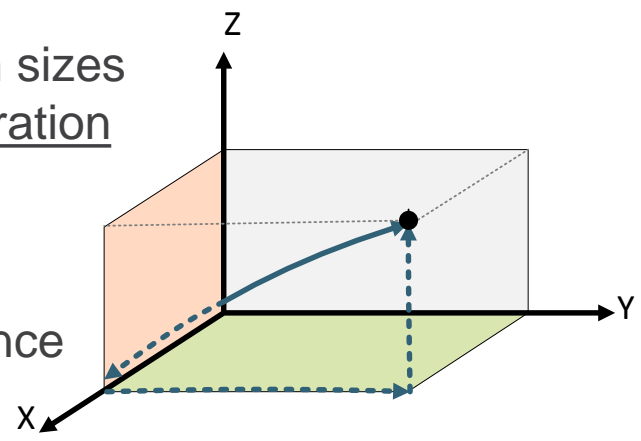

(a) Large "Batch" Increment

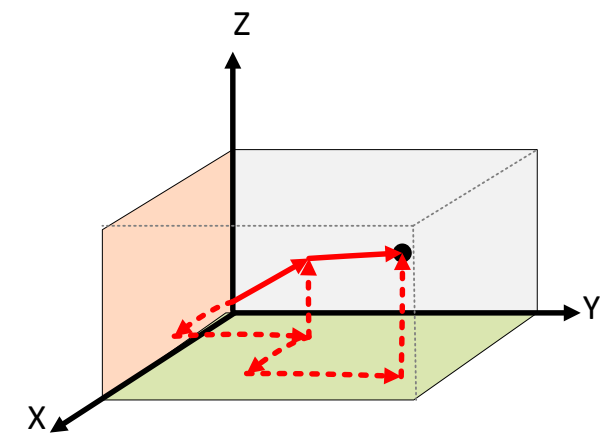

(b) Smaller "Batch" Increments

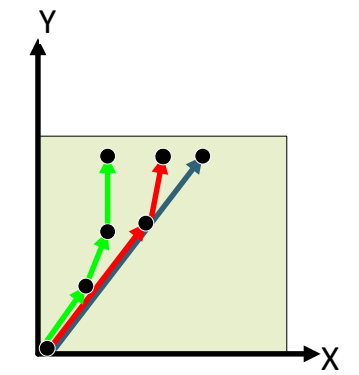

(c) Different "Batch" sizes can result in different trajectories, destinations

Information Debt: Balance Sheet Model of Learning

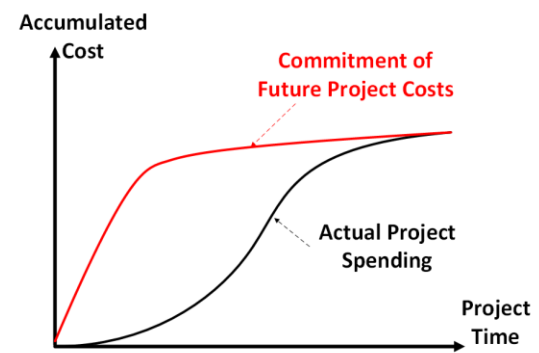

(a) When Project Costs Are Committed versus Incurred

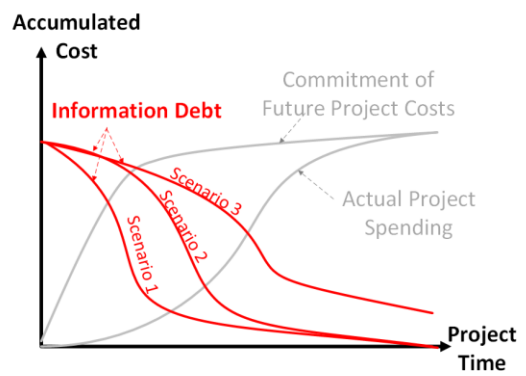

(b) Information Debt is Reduced Over the Course of Project

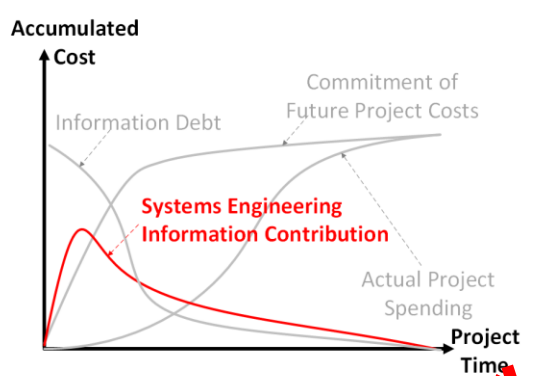

(c) Systems Engineering Information Is Generated to Reduce Information Debt

Financial Flows—Accumulated Project Costs, Information Debt, and SE Information Contribution.



System 2 Learning Observed: Explicit System 1 Patterns as Balance Sheet Assets

Platform architectures increase agility by rapidly lowering information debt earlier.

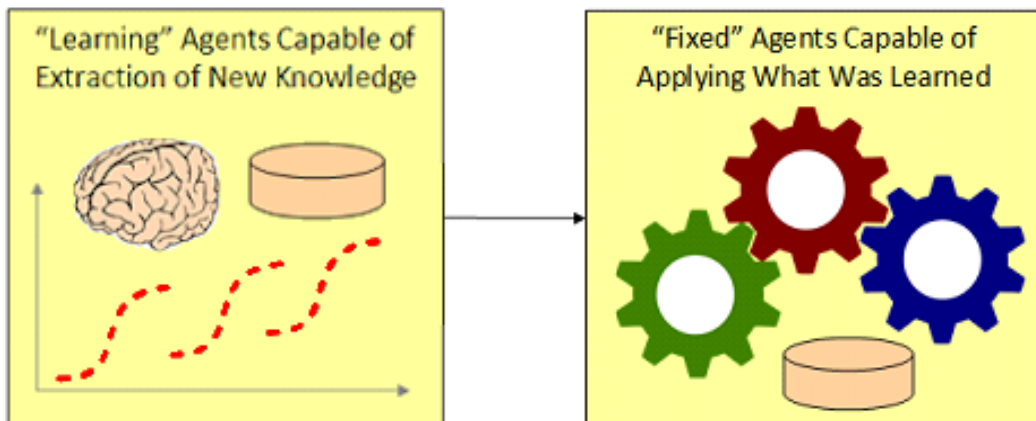
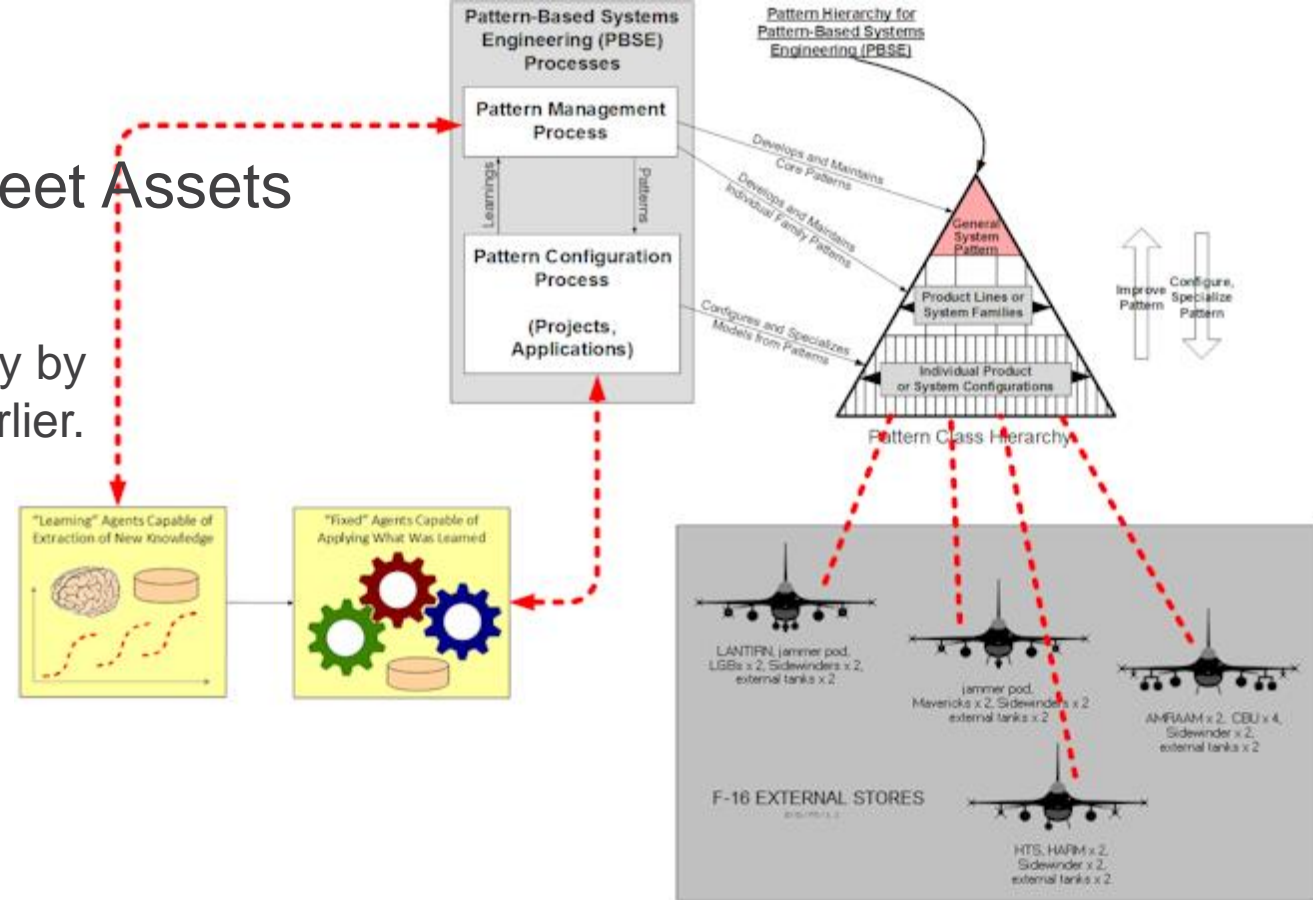

Where are the pattern assets accumulated?
ASELCM human or other learning
processes, learned assets, and their uses

3. Agile SE Process for Centralized SoS Sustainment at Northrop Grumman

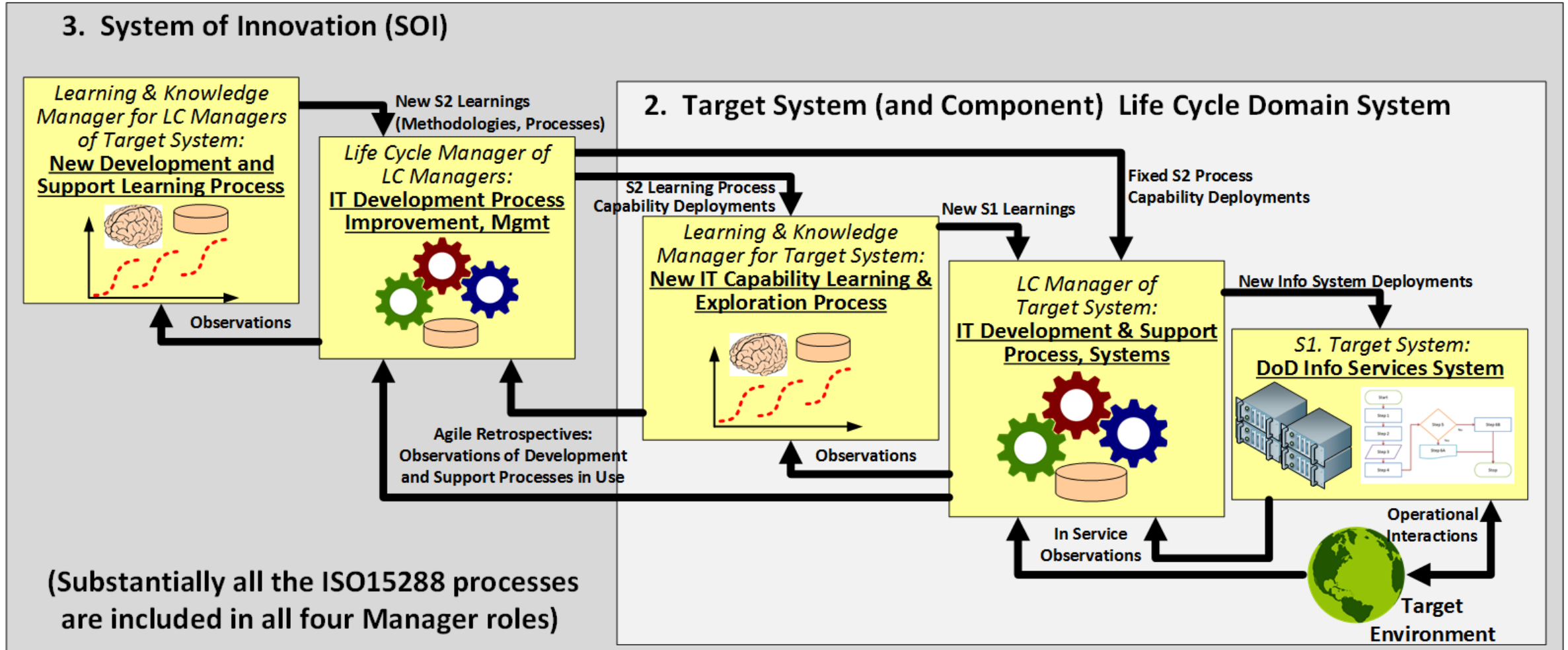

Agile trajectories in S1 Configuration Space: Optimal Control & Estimation

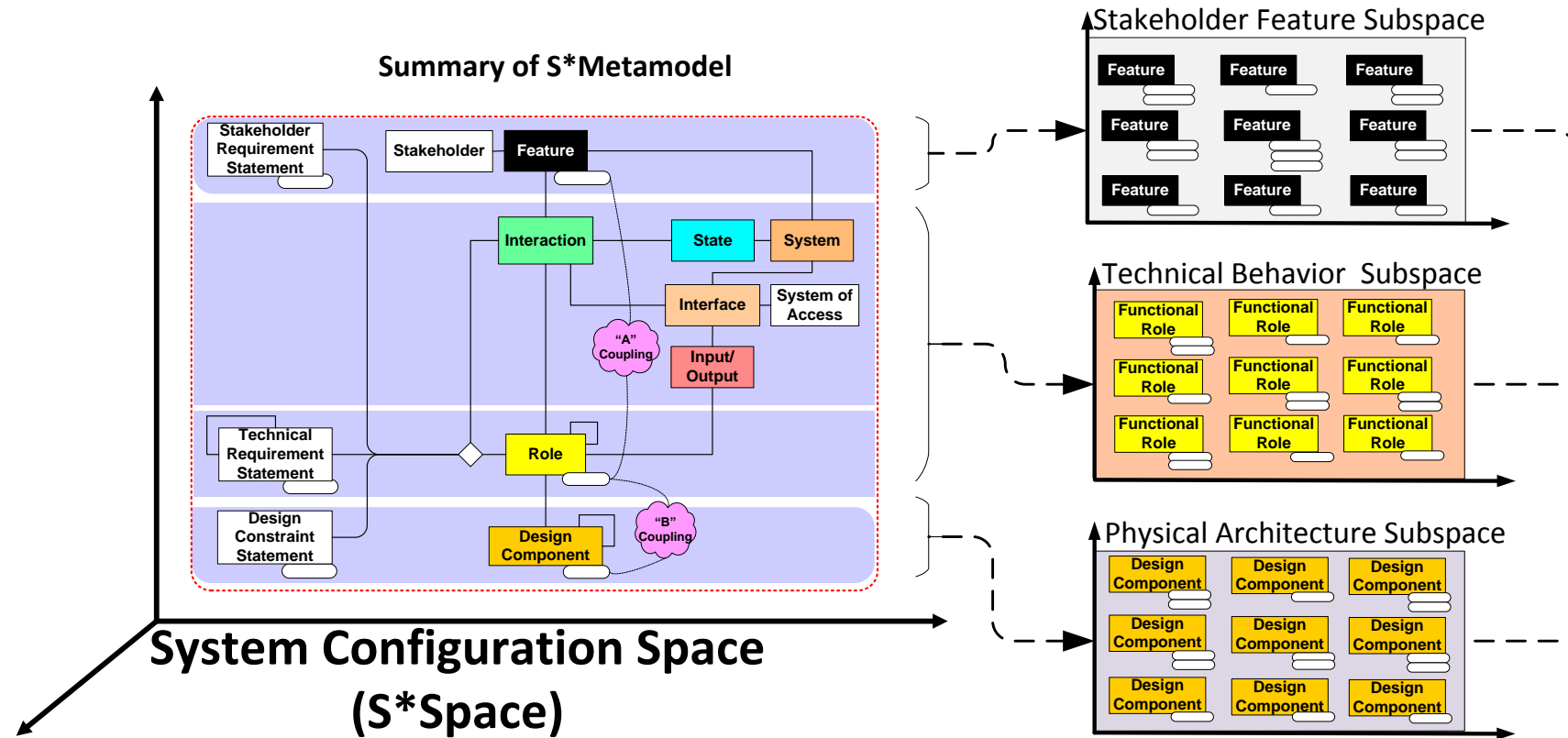

GCSS-J agile trajectory in system configuration space and sub-spaces

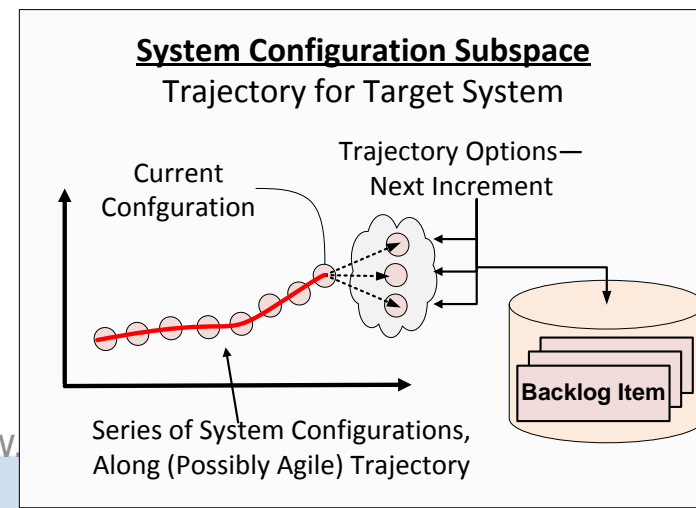

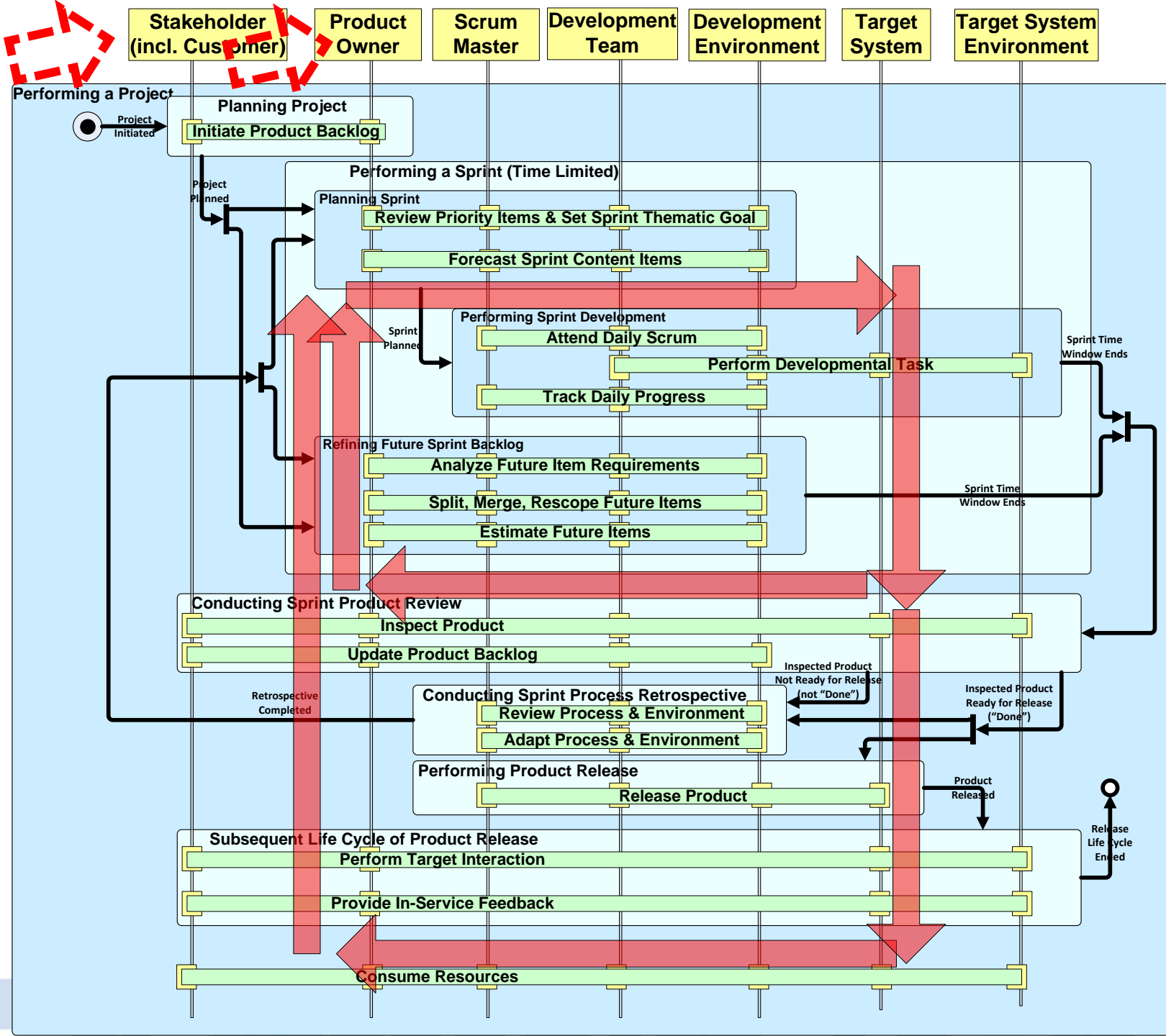

Trajectory uncertainty and risk: Trading and sharing risks, decisions

Nested feedback loop processes traverse system configuration space



States, Modes, and Learning in System 2

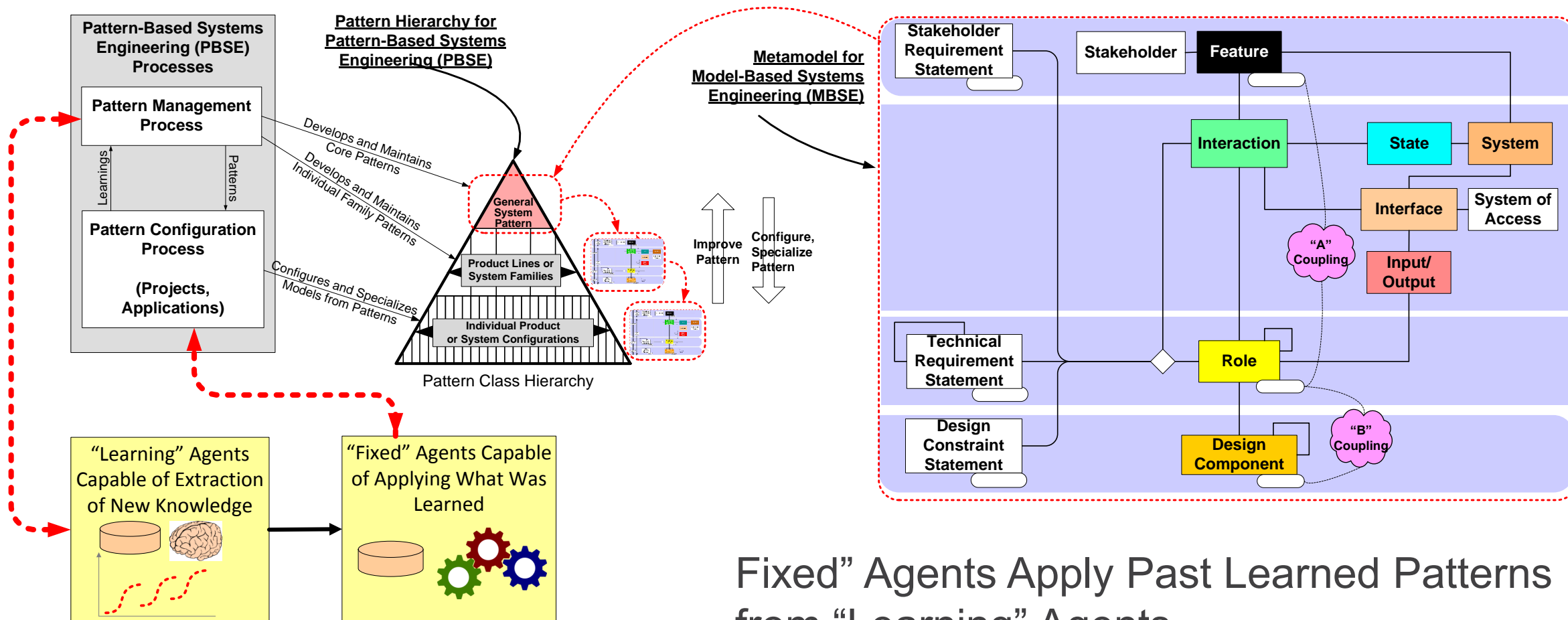

Fixed" Agents Apply Past Learned Patterns from "Learning" Agents



4. Agile Hardware/Firmware/Software Product Line Engineering at Rockwell Collins

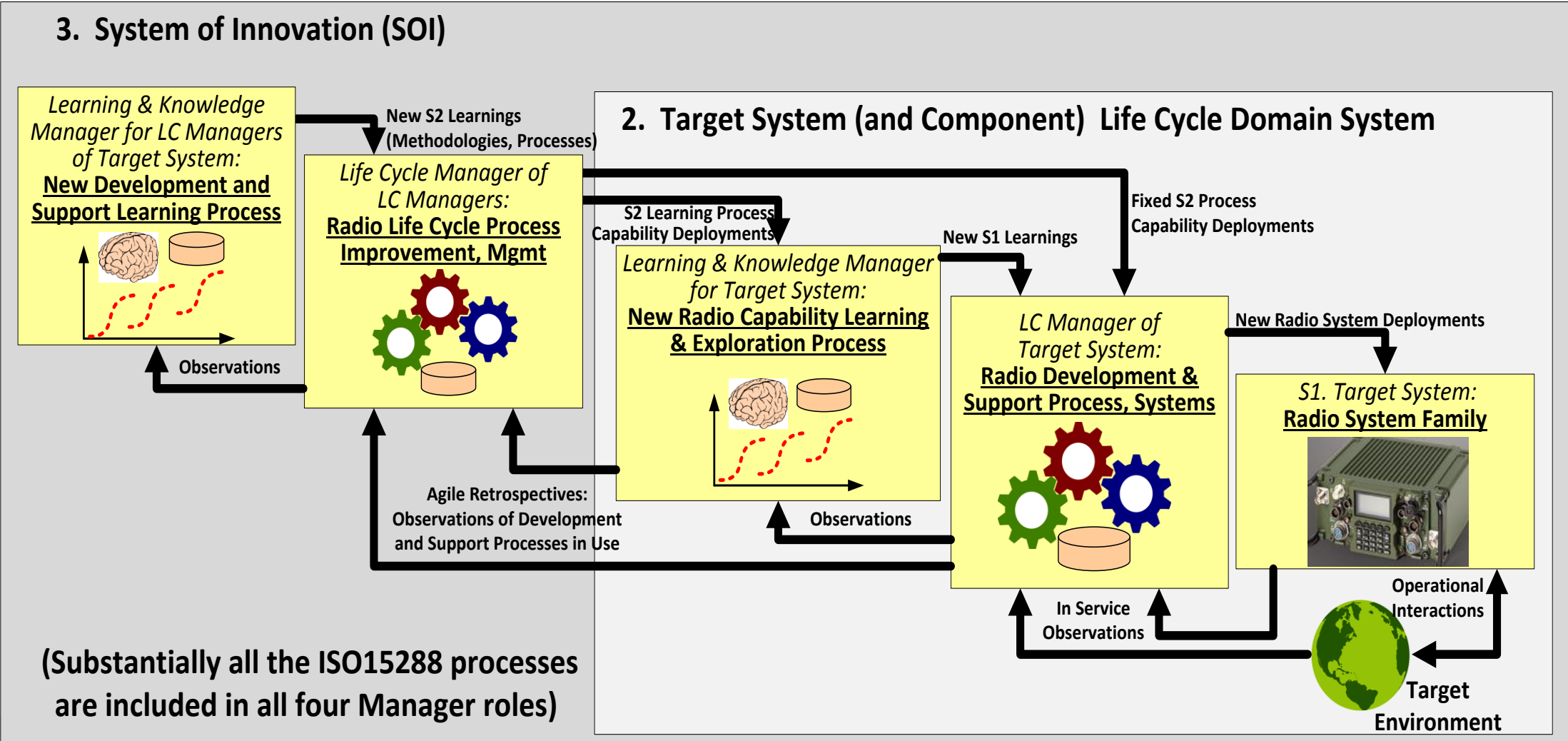

Summary of S* Metamodel

Defines System Family Configuration Space



Absorb Shock	Maintain System
Transmit	Configure System
Receive	Transport

Mounting Interface	Service Interface
Power Interface	Antenna Interface
Data Interface	Operator Interface

The system shall weigh no more than 5 pounds.

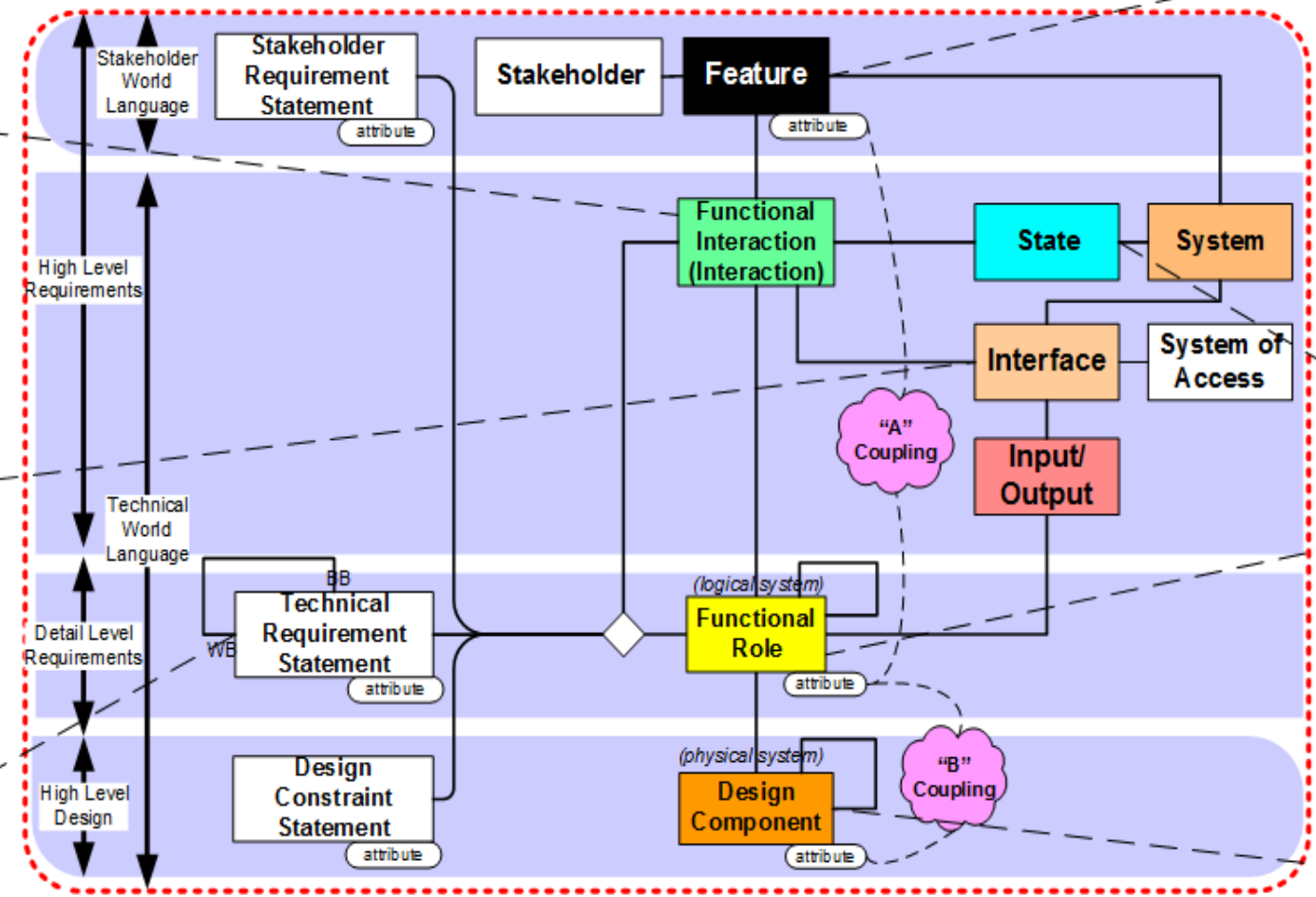

Range	Compatibility
Security	Data Transport
Mobility	Application

Being Transported	Being Served
Receiving	Transmitting

Modulator	Demodulator
Waveform Generator	Power Subsystem

Case	Circuit Card
Backplane Assembly	Front Panel

Product line family issues ultimately include the minimal system model issues (Illustrative examples for generic radio systems)



S* Pattern Hierarchy for Pattern-Based Systems Engineering (PBSE)

S* Metamodel for Model-Based Systems Engineering (MBSE)

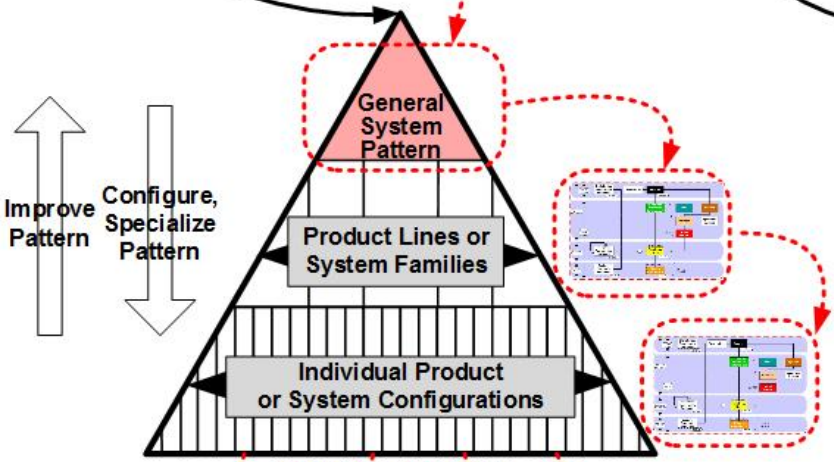

System Pattern Class Hierarchy

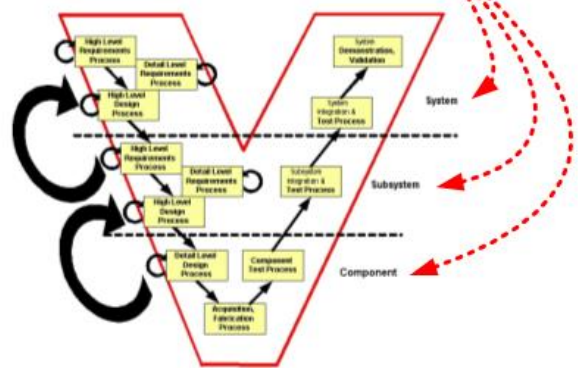
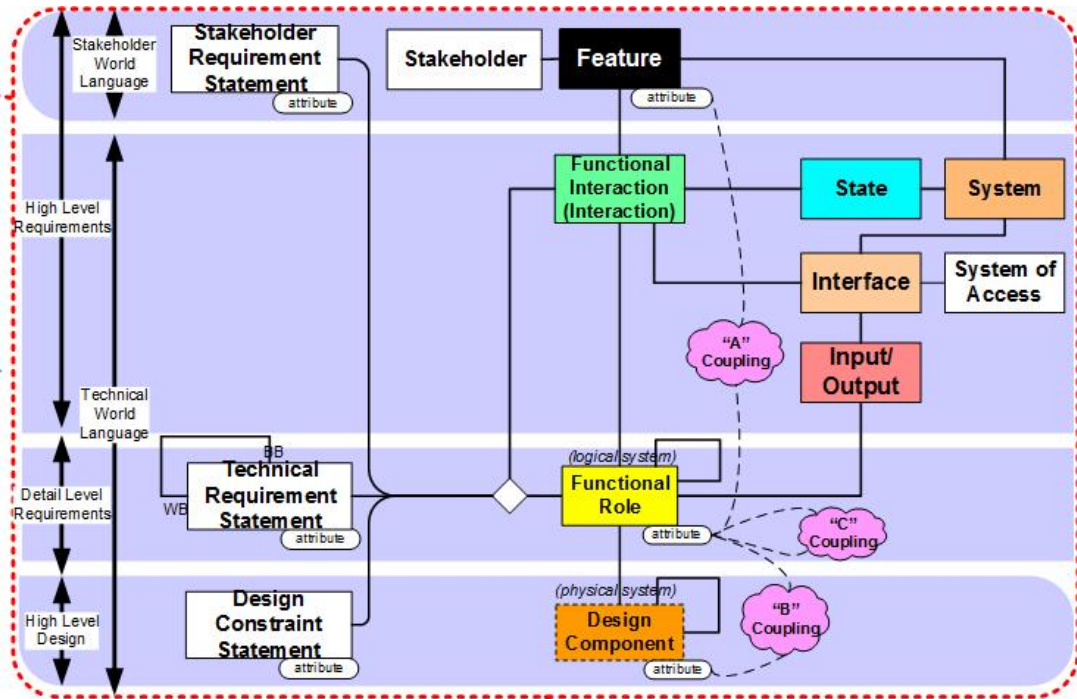

System Containment Hierarchy

Product lines configure varying products from those pattern assets.

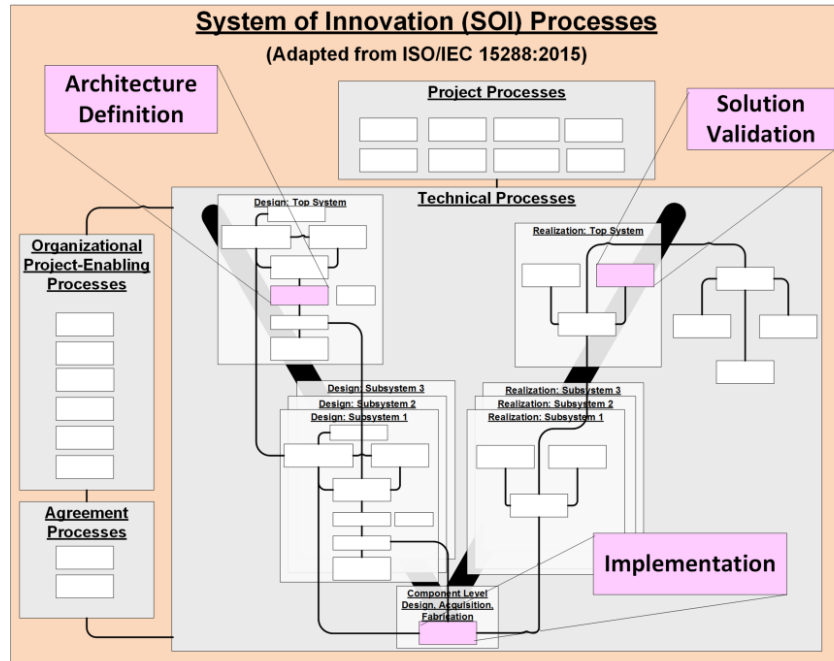

All ISO15288 life cycle processes are candidates for Product Line Engineering learning and configurability— e.g., Test

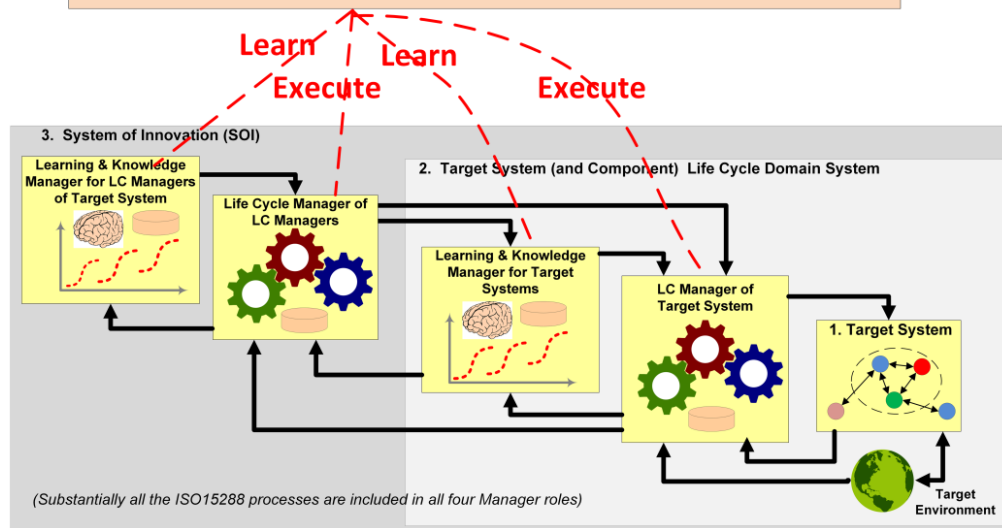



Additional Recent INCOSE ASELCM Applications

- INCOSE Agile Health Care Systems Conf. 2016:
 - Health Care Domain ASELCM Pattern
- INCOSE/IEEE/NASA EnergyTech 2016 Conf.:
 - Critical Infrastructure Domain ASELCM Pattern
 - Power Distribution Domain ASELCM Pattern

With Product Line Engineering (PLE) WG: Joint Activity Materials



- Joint Projects:
 1. Demonstration of Legacy Product Line MBSE Pattern Harvest from legacy documentation, using Method of Projections
 2. Demonstration (also with TIMLM WG) Collaborative Innovation Ecosystem, for Product Line Life Cycle Patterns & Configurations

Primary Contacts: *Hugo-Guillermo Chale-Gongora, Thales; Charles Krueger, Big Lever*

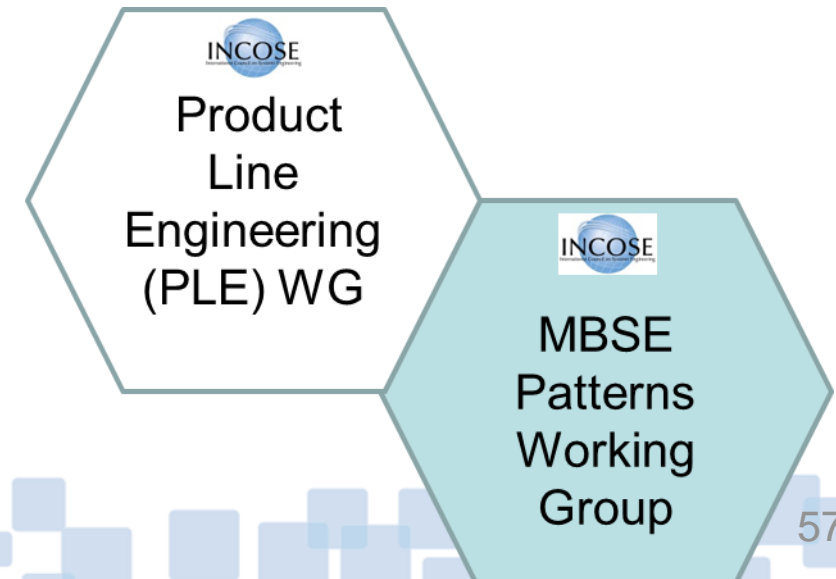

Project 1: Demonstration of Legacy Product Line Pattern Harvest, using Method of Projections



At the IW2016 joint meeting of the PLE and Patterns WGs, we reviewed a summary of the Method of Projections:

- Without a complete example, . . .
- With the intention of creating an example together in a future joint project of the two WGs.

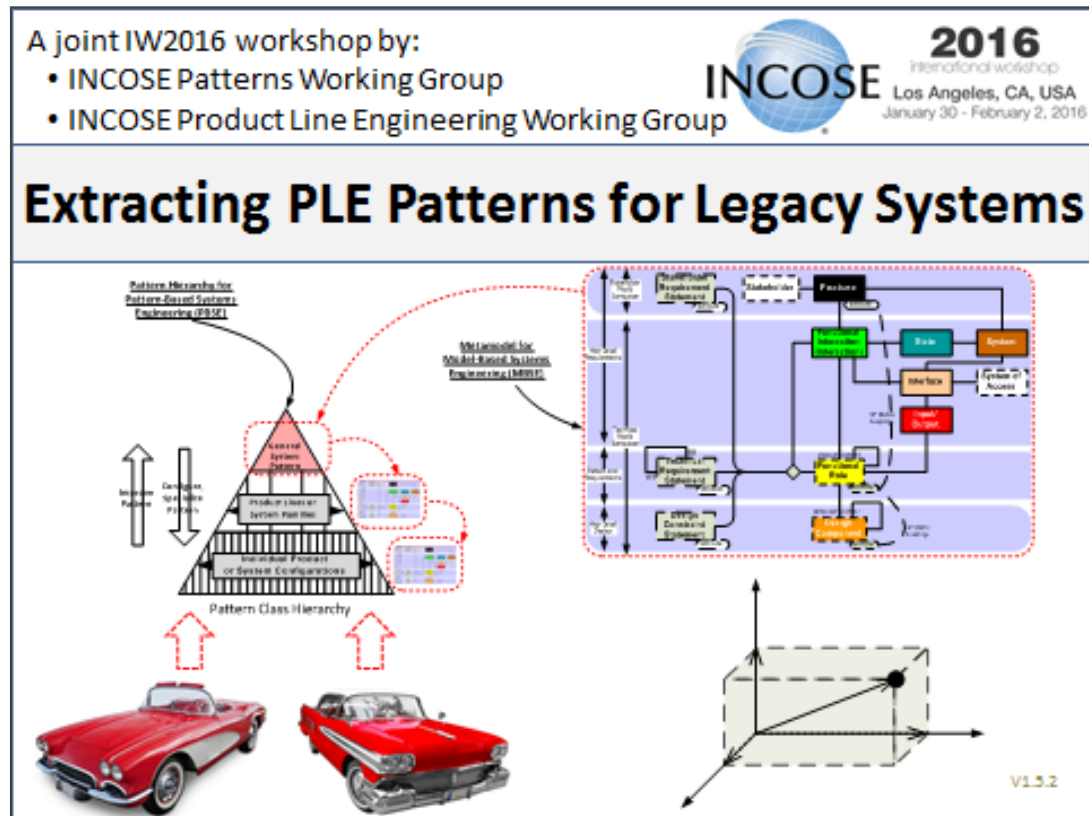

Project 1: Demonstration of Legacy Product Line Pattern Harvest, using Method of Projections



- At the IW2017, joint meeting, the PLE WG provided the Patterns WG with a real world (sanitized) sample “legacy system” family document:
 - As a potential example (safety critical compressed air supply and control system) legacy document for harvesting an MBSE PLE Pattern.

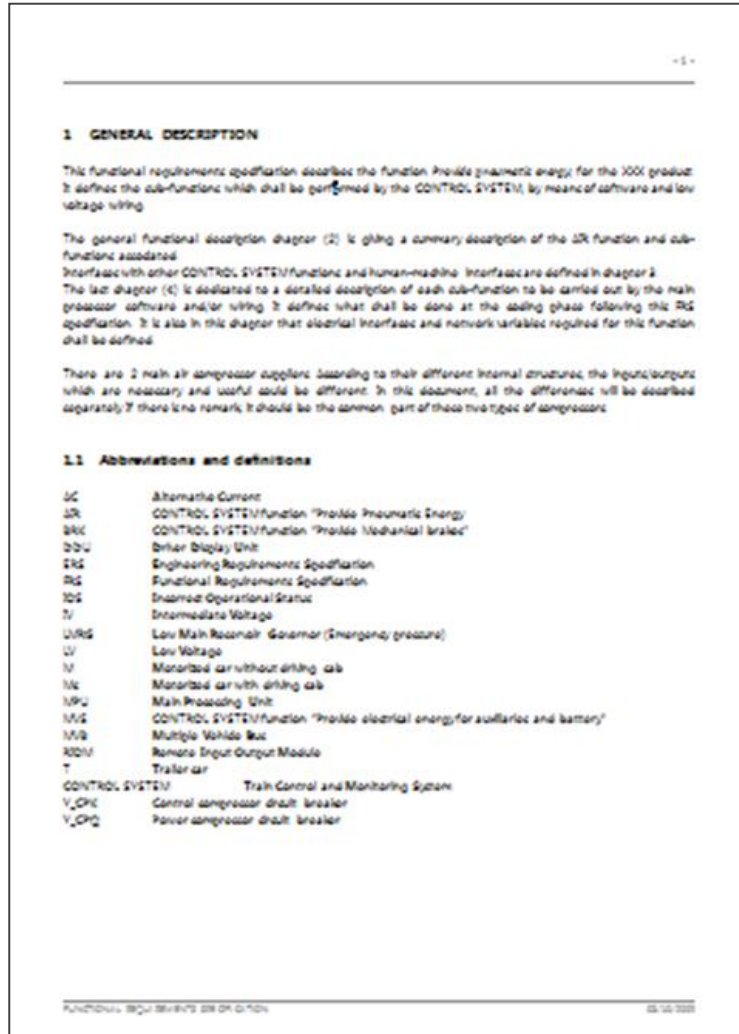

Project 1: Demonstration of Legacy Product Line Pattern Harvest, using Method of Projections



Here at IS2017, we will review the initial analysis and projection start-up for that example legacy data:

- With the special intention of deciding together some key things that we think the two WGs may agree is to be part of the special emphasis of this example;
- As the basis for continuing to work on next steps of this example.

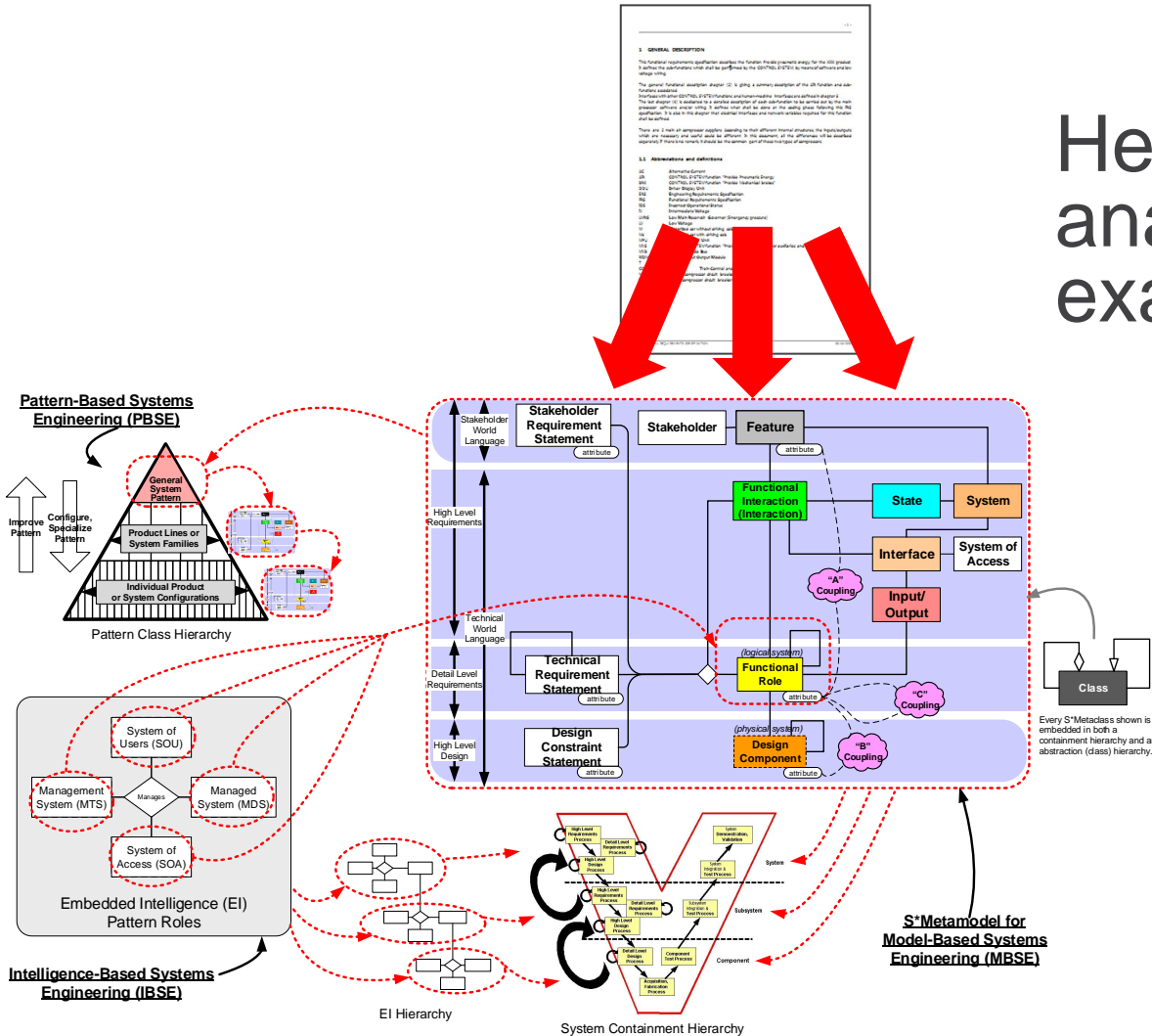

Method of Projections: Procedural Overview



1. Identify sources of Legacy Configuration information (partial, informal, the system itself, etc.) about the legacy system(s).
2. Identify an “initial guess” draft S*Pattern as a starting point—may be very incomplete, or mis-matched at first, or a portfolio parent pattern.
3. For each incremental chunk of the Legacy Configuration information:
 - a) Carry out Projection Procedure of that part of the Legacy Configuration onto the Draft Pattern, effectively re-expressing it in the Draft Pattern MBSE language.
 - b) Identify projection overshoots and undershoots compared to the Pattern.
 - c) Analyze needed refinements to the Draft Pattern.
 - d) Perform incremental adjustments to Draft Pattern.
4. Perform a trial configuration of the Draft Pattern, to re-generate a configuration of the Legacy System:
 - a) Compare the resulting configuration to the Legacy System.
 - b) Check internal configuration consistency (e.g., Requirements-Design)
 - c) Depending upon differences, repeat 3-4 if necessary.

(Although simple in principle, this is actually the PBSE form of “the loop of science”.)



Method of Projections: Procedural Overview

- If you lack any other existing pattern as the “first guess” to project onto:
 - Then project onto the base S*Metamodel
 - It is an S*Pattern in its own right, and will cause internal consistency checks on the projection that will help refine incomplete or inconsistent aspects
 - It will cause iterative discovery and structuring of the legacy data into an S*Model



Method of Projections: Procedural Overview

- *We intended* to use the S*Metamodel as our first projection target for this example:
 - *However*, the legacy example provided already had a significant content of embedded control system content
 - So, we were able to project onto the Embedded Intelligence (I) Pattern (aka Management System Pattern) as an “accelerant” for this projection
 - This is also an early example of the general projections outcome—that emergent “learning” of extracted patterns at multiple progressively specialized levels of class hierarchy, accelerates the productivity of the projections process.
 - Does the PLE WG team concur that this is one (of several) principles that we want to illustrate in this example?



Pattern-Based Systems Engineering (PBSE)

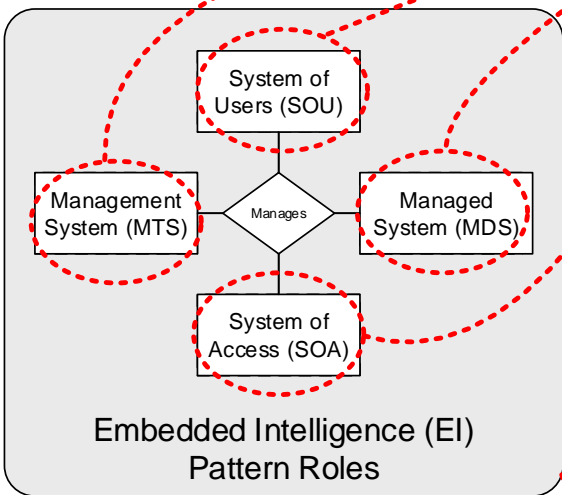
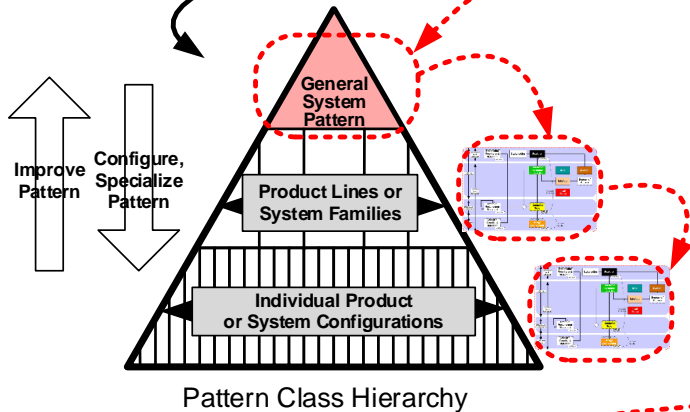

Intelligence-Based Systems Engineering (IBSE)

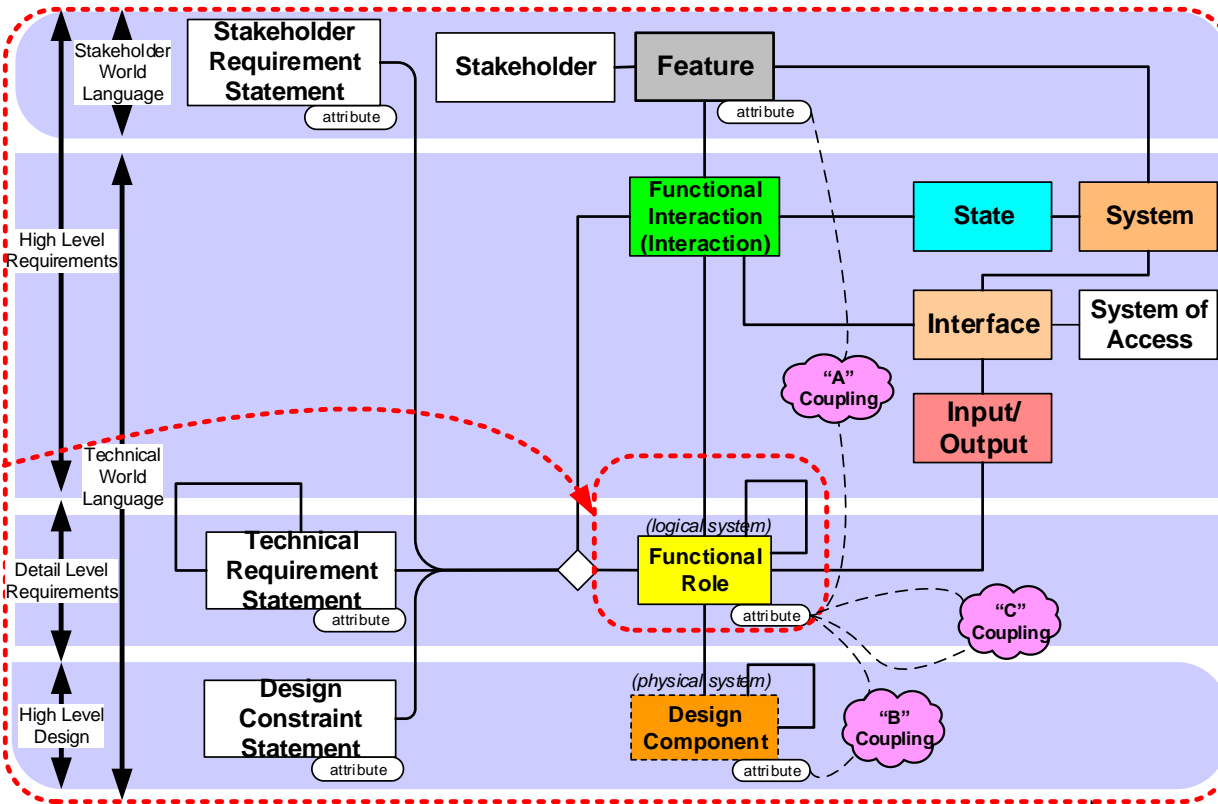

Every S*Metaclass shown is embedded in both a containment hierarchy and an abstraction (class) hierarchy.

EI Hierarchy

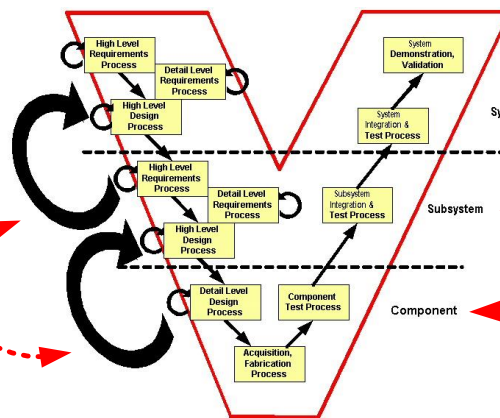

System Containment Hierarchy

S*Metamodel for Model-Based Systems Engineering (MBSE)



Emergence of Patterns from Patterns: S*Pattern Class Hierarchy

More General

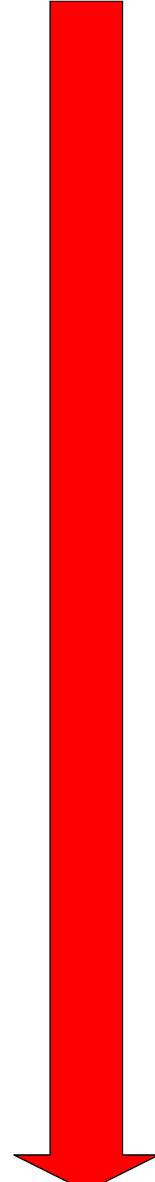

More Specific

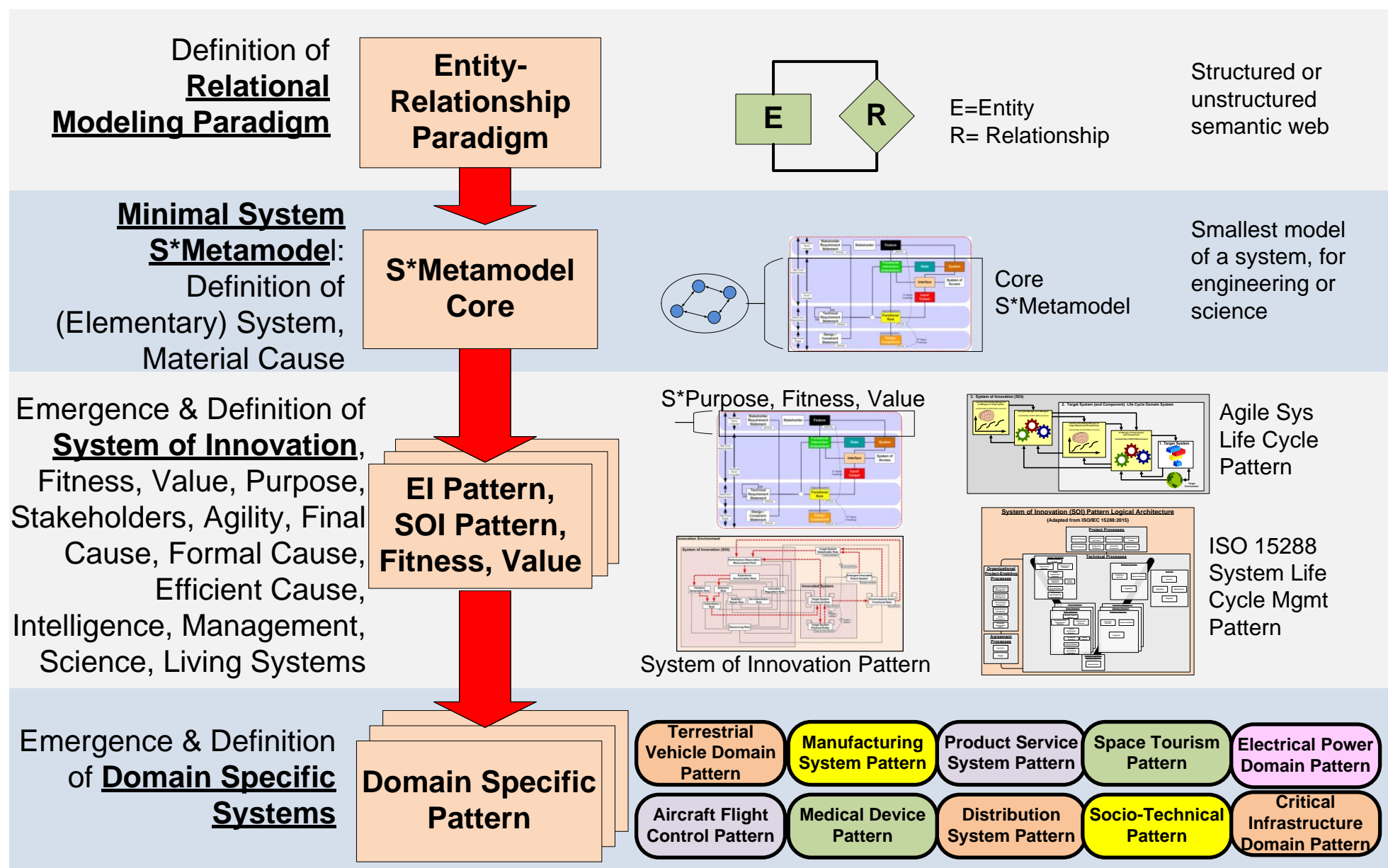

Initial projections we see emerging from the legacy document provided (if PLE WG agrees)



- System of Interest: MPU+Software (does PLE WG concur?)
- Actors: Train, Car, Reservoir, Compressor, Air Loads, Atmosphere, ...
- Interactions: Control Supply Air, Provide Management Information,
- States (Modes): Off, Idle, Daily Alternation, Normal, Assist, Emergency, Failure Modes, ...
- Input-Outputs: Supply Air, Status, Command, . . .
- Interfaces: Compressor Interface, Driver Interface, . . .
- Stakeholder Features: Air Service, Management Service, Safety, Configurability, . . .
- Requirements, Attributes, Attribute Couplings, Design Components, . . .



This caused us to pause with some questions for the PLE WG, beyond just technical correctness:

- Questions about what we want to emphasize in this example, to assure PWG adds value relevant for PLE WG . . .
- Beginning with the following preamble, checked here for agreement . . .



Preamble (assumptions going in, to check here)

1. A product line can (profitably) exist and be managed even though it is not described by a model, MBSE pattern, etc.
2. An MBSE Pattern is not a product line itself, but it can be a model of a product line.
3. Some (not all) MBSE Patterns can be said to describe Product Lines or Platform Systems.
4. Some Product Lines might already be described by MBSE Models, but not all have been.

Points of value add we want to emphasize in the example (to check here)



- Since an existing product line might not already be described by an MBSE model, then . . .
- Describing such a product line with an explicit MBSE Pattern has first of all the same kinds of potential benefits as describing system with an MBSE model:
 - reduce ambiguity,
 - improve understanding,
 - increase ability to answer analytic questions,
 - improve ability to supplement human work with automation
 - Increase ability for the whole life cycle 15288 process set to perform against a more integrated and consistent source of information

Points of value add we want to emphasize in the example (to check here)



- Product lines, and S*Patterns, have fixed and variable (configurable) aspects
- One view of an analyzed and automation-supported Product Line is that:
 - the variable aspects have been explicated, but . . .
 - the fixed parts, described by information “assets” that may not be model-based, *might* still be in legacy form

Points of value add we want to emphasize in the example (to check here)



- So, we assert that a good target for value add to the PLE WG by the MBSE Patterns WG in this example will be:
 - Even if the product line already had been analyzed for its *variable* (configurable) aspects, this demonstration adds ...
 - How to harvest an MBSE-based version of the *fixed* parts of the product line description, integrated with the variable aspects, gaining the other benefits of MBSE representation in addition to configurability.

Points of value add we want to emphasize in the example (to check here)



- In harvesting an MBSE Pattern for the content of the fixed part, the initial projection part of the Method of Projections is not the whole story . . .
- Within sub-spaces of the resulting model, the States, Interfaces, Features, and Interactions all act on each other to point out both incomplete and inconsistent aspects, leading to “blossoming” of the model in those subspaces
- This further improves the MBSE models’ completeness and consistency
- Do we agree this is one of our demonstration’s focal aspects?

System Interactions

Making the Heart of Systems More Visible

William D. Schindel
ICTT System Sciences schindel@ictt.com

INCOSE GLRC 2013: Leadership Through Systems Engineering
Copyright © 2012 by William D. Schindel
Permission granted to INCOSE to publish and use. 1.1.1

Model vs. Model Views

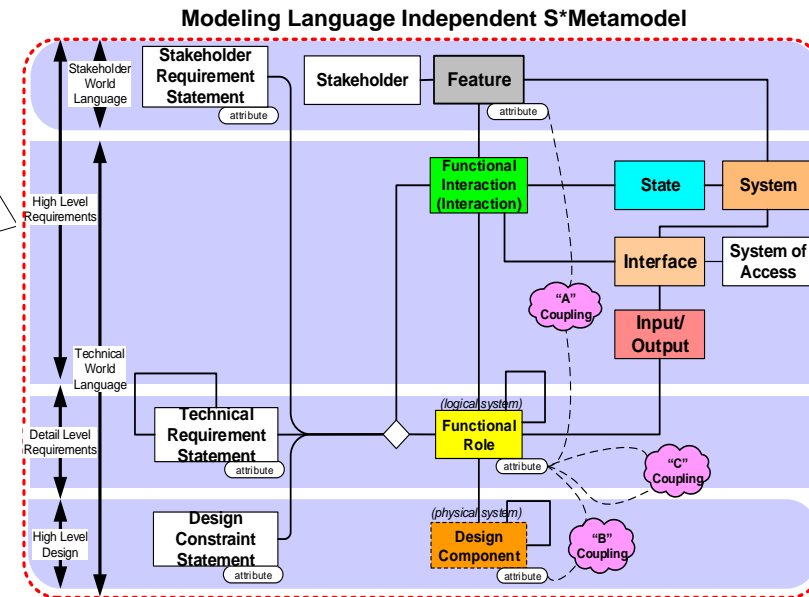
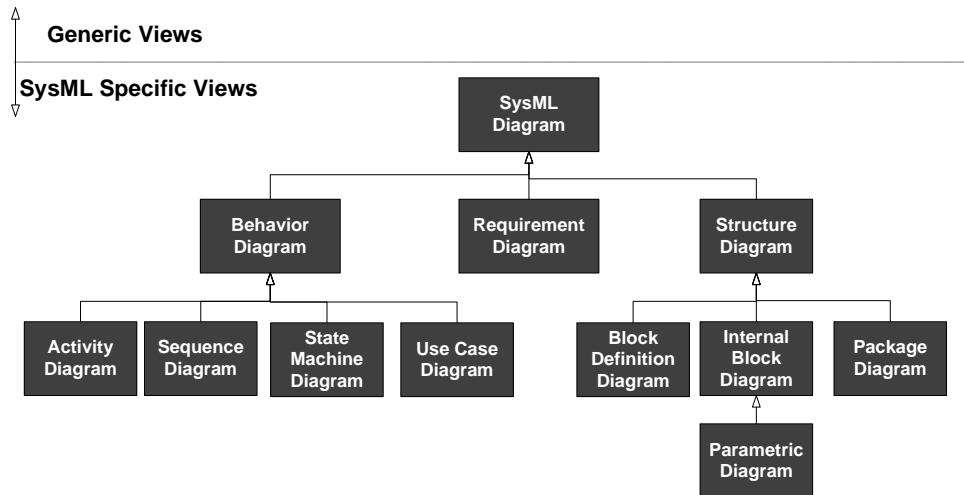
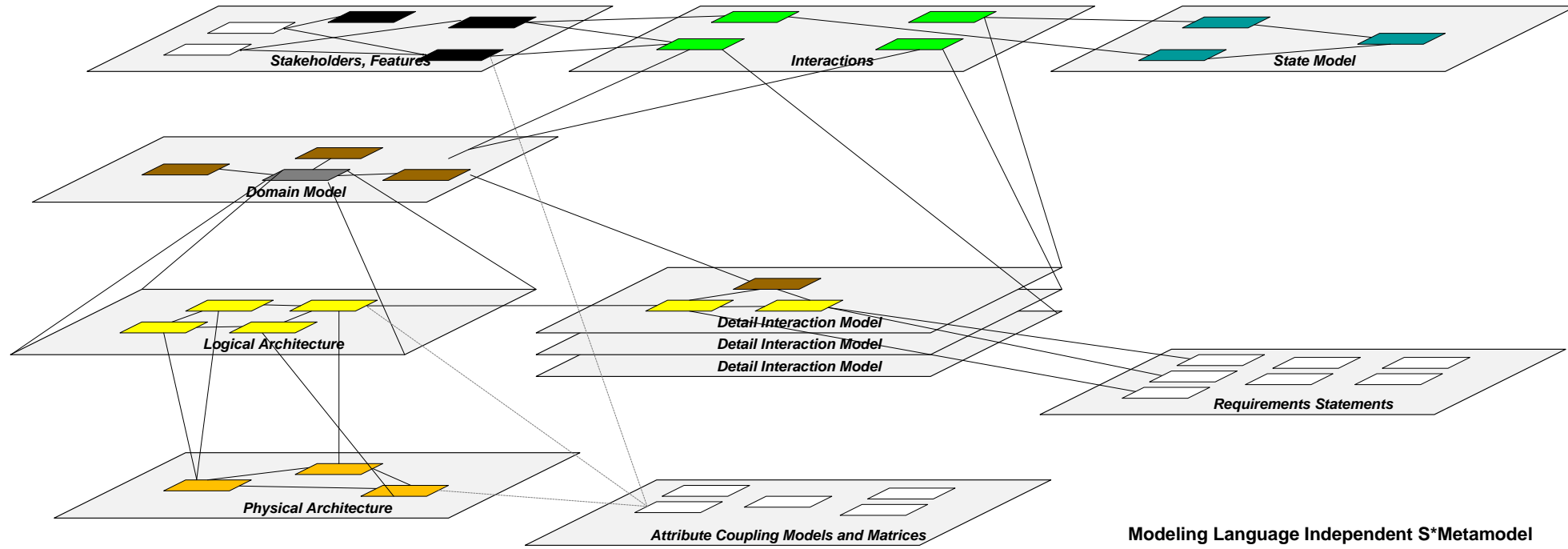

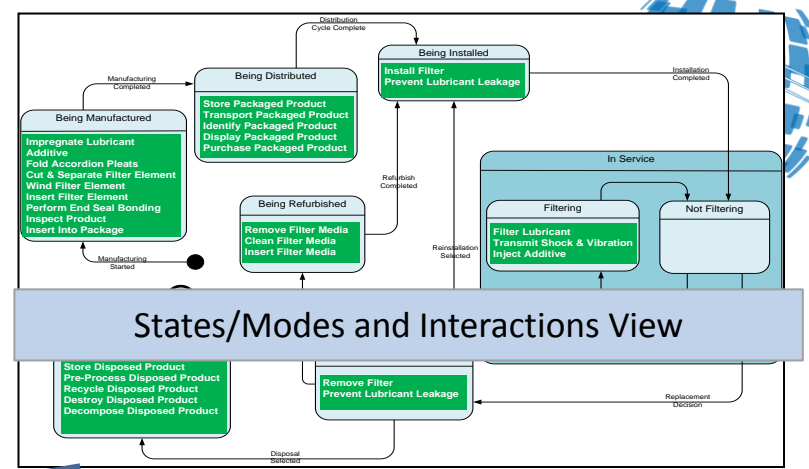
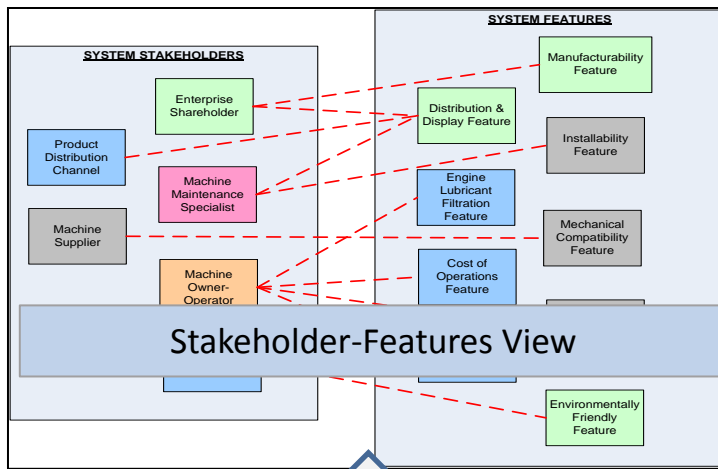
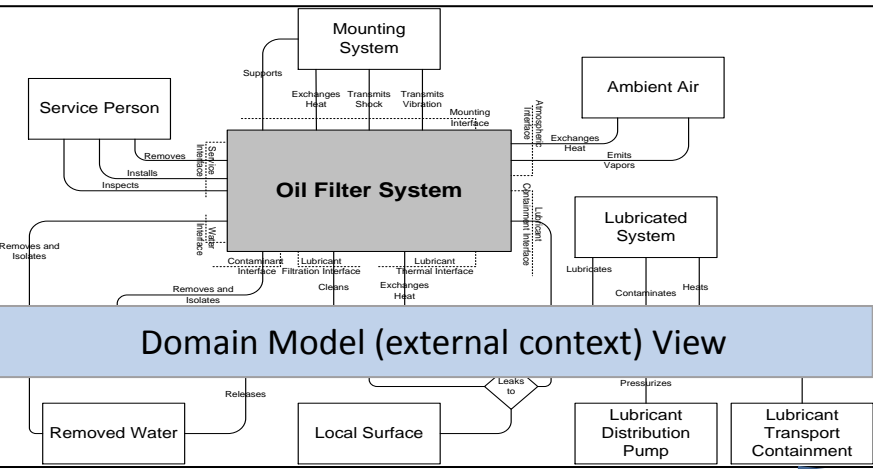

Strategy:

1. Discovering all the External Interactions

2. Discovering all the Technical Requirements

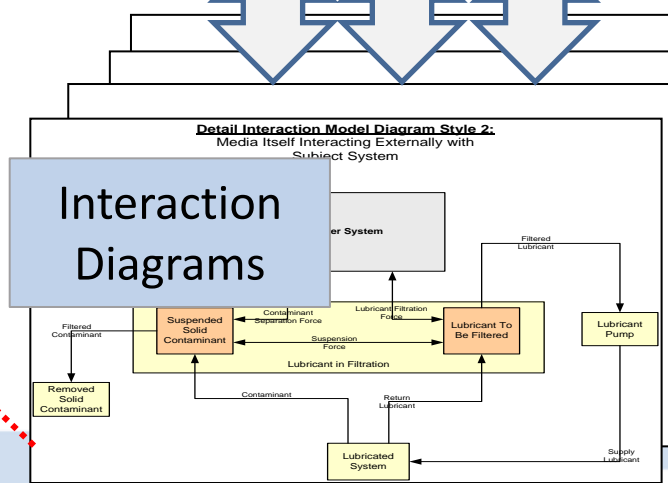
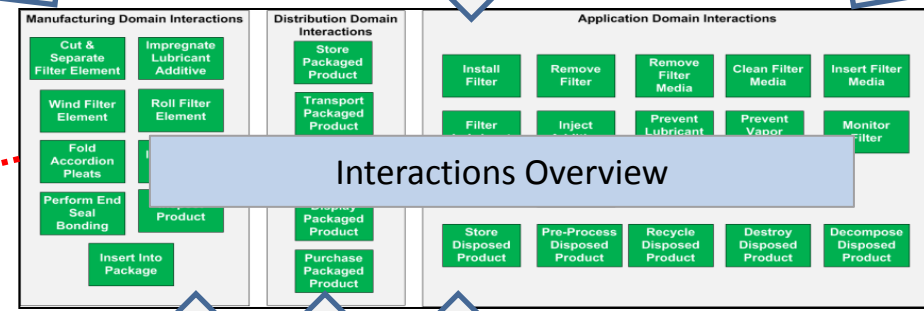

Interaction	Role	Requirement (Required or Assumed Behavior)
Filter Lubricant	Oil Filter System	For a Return Lubricant stream of [Lubricant Viscosity Range] and [Lubricant Pressure Range], the Oil Filter shall separate Filtered Lubricant output stream, [Lubricant Viscosity Range], and [Lubricant Pressure Range] within the [Lubricant Viscosity Range].
Filter Lubricant	Lubricated System	The Lubricated System shall provide a Return Lubricant stream with the [Lubricant Viscosity Range].
Filter Lubricant	Lubricated System	The Lubricated System shall provide a Return Lubricant stream with the [Lubricant Pressure Range].
Install Filter	Oil Filter System	The Oil Filter shall be installable in ten minutes or less, using only a screwdriver.
Install Filter	Oil Filter System	The Oil Filter shall have installation instructions printed on its exterior surface, in English.
Install Filter	Service Person	The Service Person shall have the visual acuity and hand strength of an average 40 year old adult.
Install Filter	Service Person	The Service Person shall be capable of reading English at the tenth grade level.

Technical Requirements

2. Inherent Relational Checks of Detail Level Model Completeness / Consistency (Model Metrics)

Requirements Statements are Transfer Functions

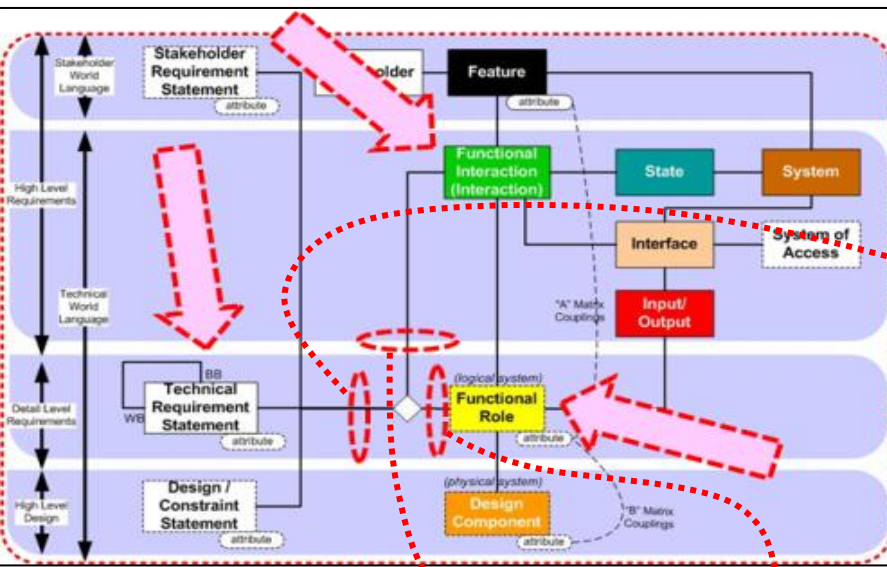

Interaction	Role	Requirement (Required or Assumed Behavior)
Filter Lubricant	Oil Filter System	For a <u>Return Lubricant</u> stream of [Lubricant Viscosity Range] and [Lubricant Pressure Range], the Oil Filter shall separate <u>Filtered Contaminant</u> particles from the <u>Lubricant</u> output stream, according to the [Filter Particle Size Distribution Profile].
Filter Lubricant	Lubricant in Filtration	The Lubricant in Filtration shall have viscosity within the [Lubricant Viscosity Range].
Filter Lubricant	Lubricant Distribution	The Pump shall maintain oil pressure within the [Lubricant Pressure Range].

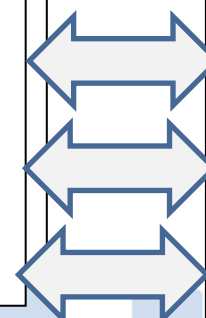
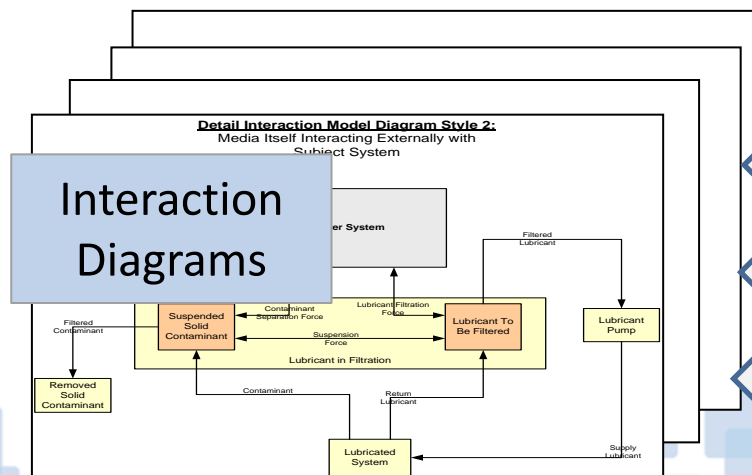

Interaction	Role	Requirement (Required or Assumed Behavior)
Filter Lubricant	Oil Filter System	For a <u>Return Lubricant</u> stream of [Lubricant Viscosity Range] and [Lubricant Pressure Range], the Oil Filter shall separate <u>Filtered</u> <u>Lubricant</u> output stream, according to the [Filter Particle Size Distribution Profile].
Filter Lubricant	Lubricant in Filtration	The Lubricant in Filtration shall have viscosity within the [Lubricant Viscosity Range].
Filter Lubricant	Lubricant Distribution	The Pump shall maintain oil pressure within the [Lubricant Pressure Range].
Install Filter	Oil Filter System	The Oil Filter shall have installation instructions printed on its exterior surface, in English
Install Filter	Service Person	The Service Person shall have the visual acuity and hand strength of an average 40 year old adult.
Install Filter	Service Person	The Service Person shall be capable of reading English at the tenth grade level.

Technical Requirements



Summary of “why’s” for this project

- To illustrate:
 - How to harvest an MBSE Pattern description of the fixed parts of a legacy product line from legacy documents (along with the variability, which may already have been captured)
 - That the MBSE Pattern description of the fixed part of the pattern adds value in the form of:
 - reduced ambiguity,
 - improved understanding,
 - increased ability to answer analytic questions,
 - improved ability to supplement human work with automation
 - Increased ability for the whole life cycle 15288 process set to perform against a more integrated and consistent source of information
- Do we agree?



Next steps

- If we agreed,
 - Show the initial projection
 - Show the subsequent blossoming
 - Generate a package connected to the intended use and benefits
 - Other?

Project 2: Demonstration Collaborative Innovation Ecosystem, for Product Line Life Cycle Patterns & Configurations



INCOSE MBSE Patterns Working Group

Contributions to Reference Ecosystem for Collaborative Innovation

For Product Line Life Cycle
Patterns & Configurations



MBSE Patterns Working Group

V1.2.9

Project Objectives

1. Specify, construct, and demonstrate a reference ecosystem of product life cycle tools, processes, and example content . . .
2. Illustrating a vision (or set of visions) of future approaches to collaboration between people and information systems, integrated across the ISO15288 system life cycle processes . . .
3. Leveraging the concepts of sound systems engineering, model-based representations and patterns, product line engineering, and agility in the face of risk, variability, and uncertainty . . .
4. Integrating the work and resources of multiple INCOSE Working Groups in related areas . . .
5. By providing this point of reference, accelerating the Model-Based Transformation described by INCOSE Vision 2025 and encouraged by the INCOSE Board of Directors adopted strategic objective.

Working Groups Involved

- MBSE Patterns Working Group
- Product Line Engineering Working Group
- Tools Interoperability and Model Life Cycle Management Working Group

(*) Discussed by these three WGs at INCOSE IW2017.

Patterns Working Group

Contributions to this Project

- ASELCM System 1 Patterns: S*Pattern-based representation of engineered systems, over their life cycle, including product line patterns and specific configurations thereof. (This is system 2 work.)
- ASELCM System 2 Patterns: S*Pattern-based representation of the systemic patterns of (human, machine) activity characterizing System 2 collaboration over System 1 life cycles; including general patterns and specific configurations thereof. (This is System 3 work.)

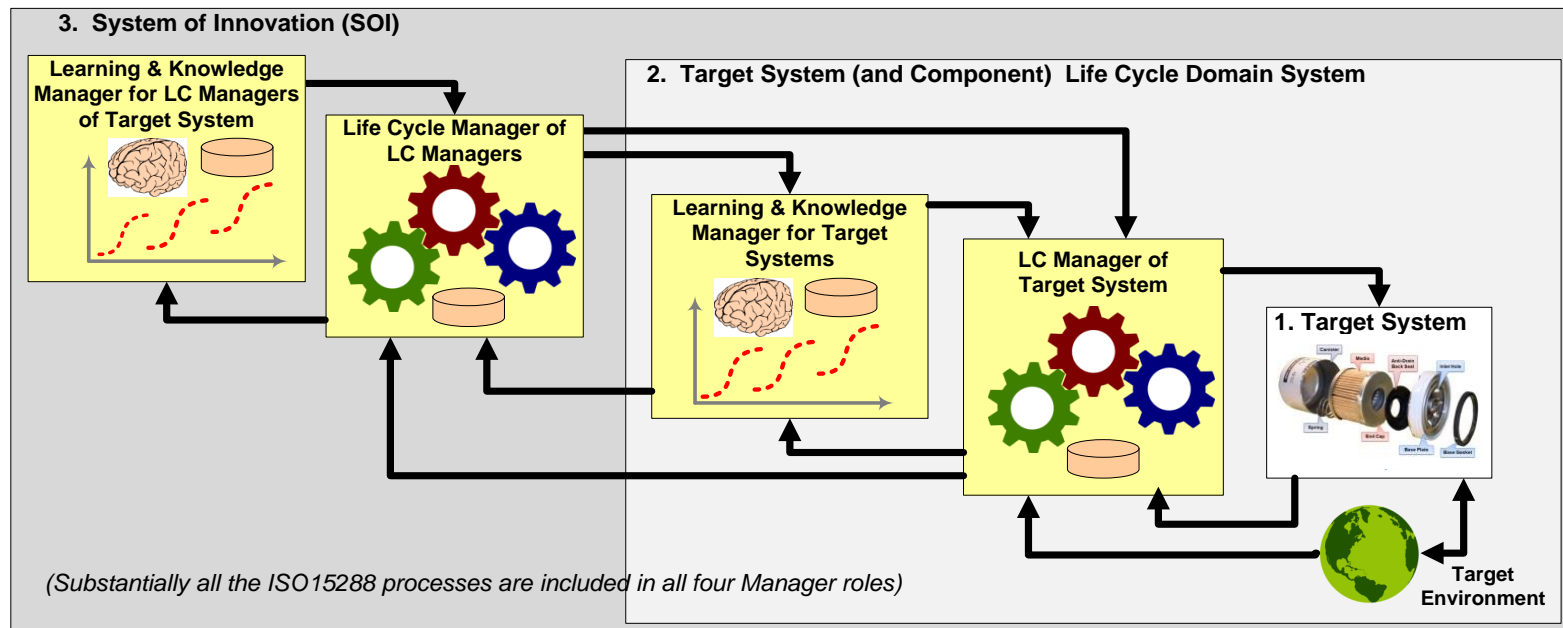

**ASELCM
Pattern**

Patterns Working Group

Contributions to this Project

- ASELCM System 1 Patterns: S*Pattern-based representation of engineered systems, over their life cycle, including product line patterns and specific configurations thereof. (This is system 2 work.)
- ASELCM System 2 Patterns: S*Pattern-based representation of the systemic patterns of (human, machine) activity characterizing System 2 collaboration over System 1 life cycles; including general patterns and specific configurations thereof. (This is System 3 work.)

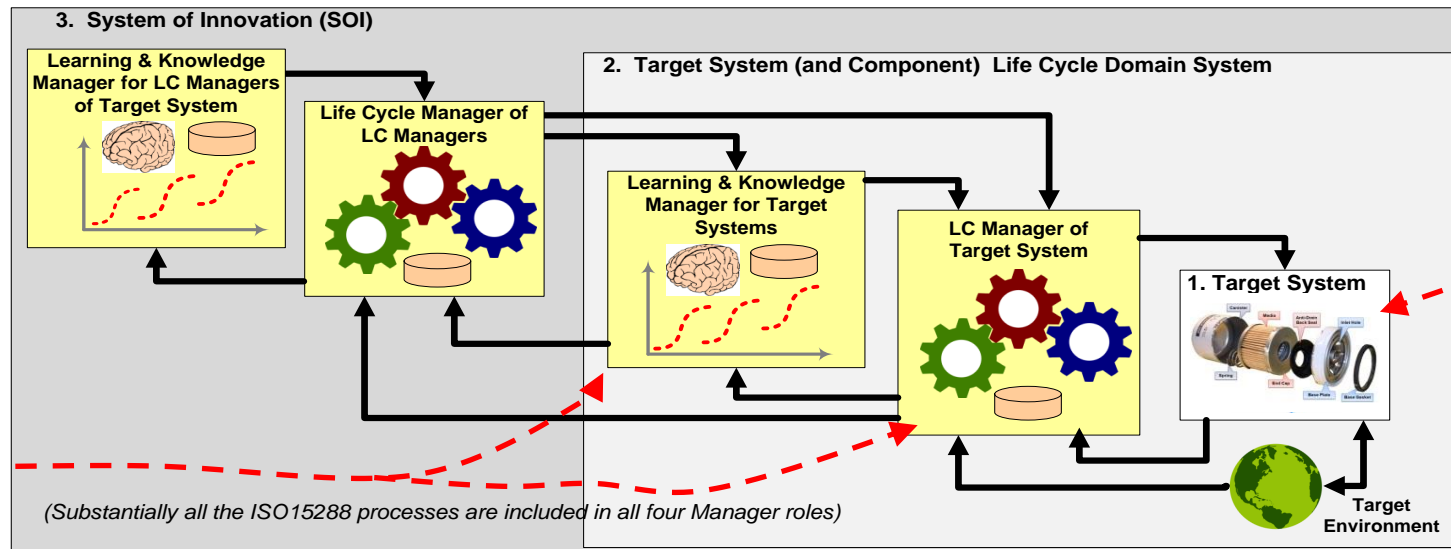

**ASELCM
Pattern**

We expect this project will involve contributions of ideas, effort, or otherwise from multiple external sources

- Currently in very early stage, using ideas, products, information, effort from the following, with more expected to get involved over time . . .



More to follow, especially to cover ISO15288 Life Cycle Processes

System 1 Model Content

- Product Line Model S*Pattern—for Oil Filter Family Product Line:
 - And product configurations thereof, over their life cycles
- Related Manufacturing System S*Pattern—for Oil Filter Manufacturing Platform Product Line:
 - And system configurations thereof, over their life cycles
- Represented as S*Patterns and S*Models, in multiple COTS tools for model authoring, analysis, simulation, configuration management, and otherwise.

Preliminary System 1 Example Data

- Oil Filter S*Pattern:
 - Descriptive product line document samples
 - Modeled in multiple SysML modeling tools
 - Integrated with configuration agent capabilities, for creating configured S*Models from S*Patterns
- S*Examples of the above, in progress so far:
 - Magic Draw/CSM + Big Lever Gears
 - Enterprise Architect + Reference Configuration Agent
 - Other types of tools and information systems to follow



With ASME Model V&V Committees: Model V&V Joint Activity Materials

Primary Contacts:
*Joe Hightower, Boeing,
Gordon Shao, NIST,
ASME VV50 Committee*

- Supporting creation of ASME Guidelines & Standards for Managing Credibility (Model VVUQ) of Computational Models, over their Life Cycles

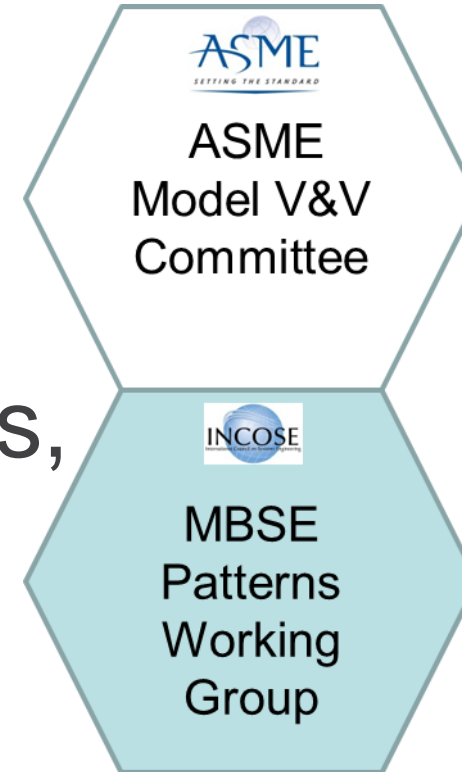

With ASME Model V&V Committees: Model V&V Joint Activity Materials





**Establishing Model Credibility
Using Verification and
Validation**

Joe Hightower
Sr. Quality Engineer
Associate Technical Fellow
The Boeing Company

1/27/2017 1

IW2017 MBSE
Workshop talk

Report on ASME Verification &
Validation of Computational Modeling

ASME V V 50 Committee--V&V of Computational
Modeling for Advanced Manufacturing;
Meeting Nov 7-8, 2016, Schenectady, NY

Bill Schindel schindel@ictt.com

 V1.2.3

Report on ASME Verification & Validation of Computational Modeling

ASME V V 50 Committee--V&V of Computational Modeling for
Advanced Manufacturing;

Meeting Nov 7-8, 2016, Schenectady, NY

Bill Schindel schindel@icctt.com

Content

- Purpose and Scope
 - Intended Audience & Interests
 - Background on ASME Model V&V Activities
 - Model Verification and Validation – Awareness
 - The Opportunity for ASME and INCOSE
 - November 7-8, 2016, V V 50 Meeting—Topics
-
- References
 - VV50 Committee Leadership

Purpose and Scope

- This is a report on the ASME V V 50 Standards Committee on V&V of Computational Modeling in Advanced Manufacturing.
- This report is focused on the Nov 7-8, 2016 meeting of the committee, but also includes general background on the ASME Standards Committees on Verification and Validation of Computational Modeling.
- This report is the for the Intended Audiences listed on the next page, and is focused on only certain limited aspects of the above.
- See the References for more information, or contact the author.

Intended Audience & Interests

- INCOSE MBSE Leadership, INCOSE Patterns Working Group, and INCOSE Crossroads of America (CoA) Chapter
- Indiana Virtual Verification Institute (V4I) Core Team
- Enterprises applying MBSE models

Intended Audience & Interests

- Reason for interests:
 - Although the use of models is not new, it is continuing to increase in importance and frequency.
 - There is not a shared agreement, across individuals and organizations, as to the description of uncertainty, risk, or confidence in those models.
 - As potential reliance on models grows, the need for such a framework also grows—trust is essential to commerce and society.
 - This is not just true for the “computational models” of interest to the ASME standards effort, but also to the more general class of “system models” (of which the former are a part) over system life cycles, of interest to the INCOSE systems community.
 - INCOSE sees the opportunity to collaborate with ASME, in describing frameworks that are as consistent as appropriate.

Background on ASME Model V&V Activities

- ASME generates formal standards across a wide range of subjects.
- Because the use of computational modeling and simulation of physical systems (e.g., FEA models, dynamical simulations, etc.) has become widespread, ASME formed a standards committee effort related to the verification and validation of such models.

Model Verification and Validation – Awareness

- Systems engineers and others are used to referring the “verification and validation” as related to designed systems, in this way:
 - Validation that the stated candidate requirements for a real system are appropriate in the eyes of the stakeholders in that system. (*Are we working on the right requirements?*)
 - Verification that the that a stated candidates design for a real system will result in a system meeting the stated requirements for that system. (*Are we working on the right design?*)
- However, the ASME Model VV effort is directly concerned not with the above V&V of systems, but instead with the verification and validation of computational models:
 - Although those might even be models of the same system as referenced above, the V&V of those models turns out to be a different idea than the V&V of the systems.

V&V of Models, Per Emerging ASME Model V&V Standards

Does the Model adequately describe what it is intended to describe?

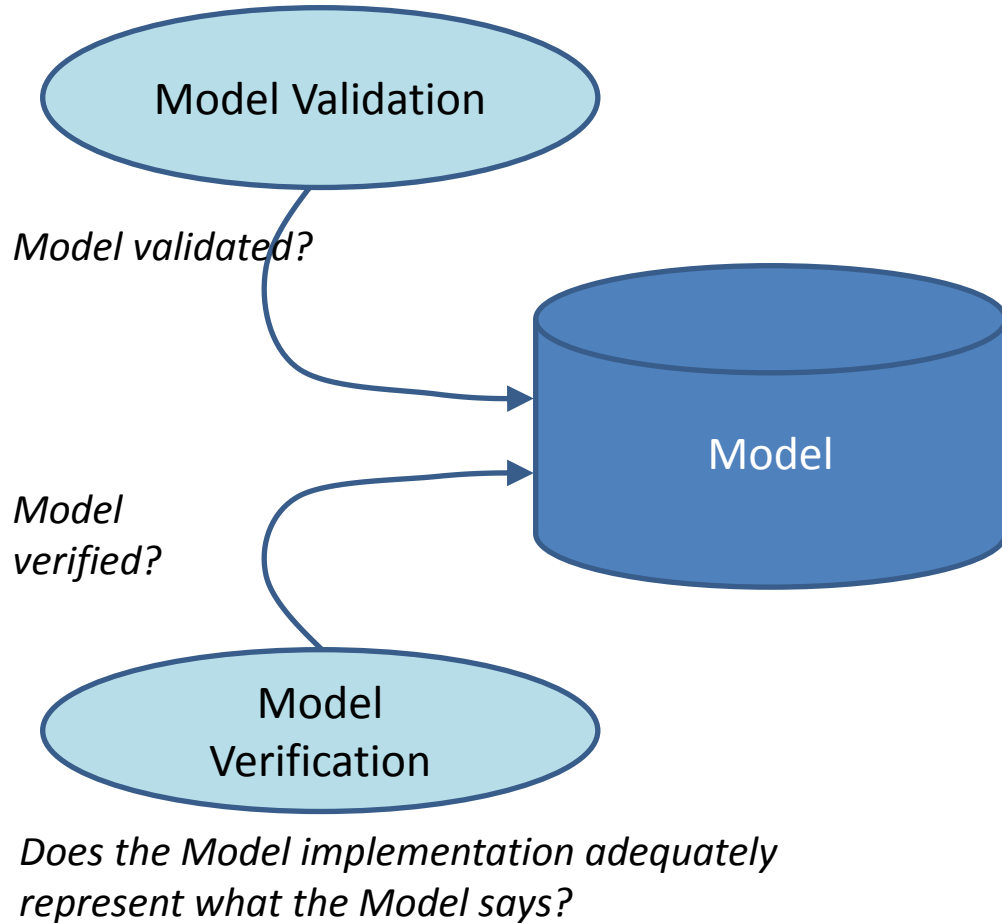

V&V of Systems, Per ISO 15288 & INCOSE Handbook

Do the System Requirements describe what stakeholders need?

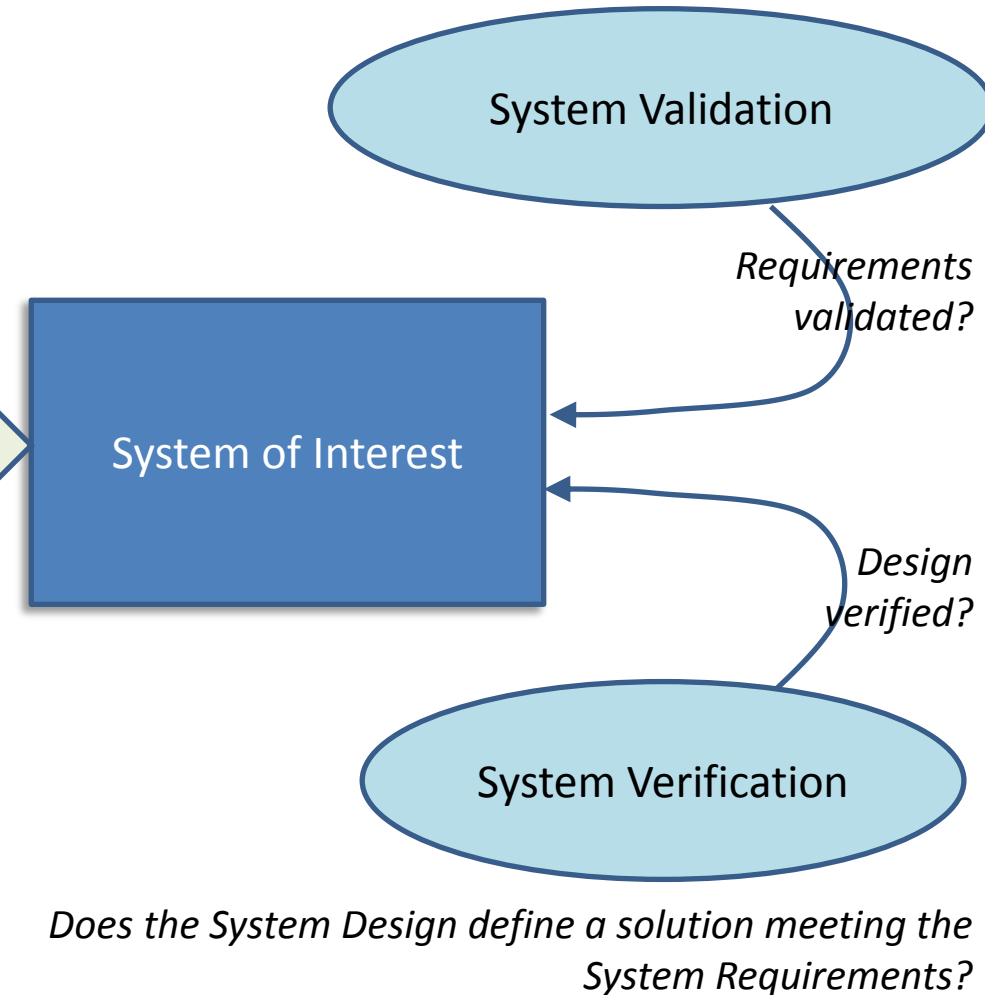

Don't forget: A model (on the left) may be used for system verification or validation (on the right!)

Computational Models: Additional Distinguishing Aspects

- An additional distinction in currently visible models and modeling efforts is also delineated by the model V&V effort:
 - Internal “Physics-Based Models”: These describe *and explain* external system behavior, using model content that shows how externally-visible behavior is generated by internal interactions, based on physics or other “scientific” or first principles models, of at least one level of decomposition. The emphasis is on discovery and use of the explanatory science of the decomposition.
 - External (black box) “Data Driven Models”: These describe external system behavior, but solely in terms of the “black box” patterns of that behavior that can be seen externally, without regard for any “internal why” explaining the internal origin of that behavior. The emphasis is on discovery and use of the patterns of external behavior.
 - “Hybrid” Models: These combine both of the above aspects.

Data Driven Models “Black Box”

What is the behavior of the System of Interest, visible externally to the external actors with which it interacts?

Special interests: Tools and methods for discovery/extraction of recurring patterns of external behavior. Data Scientists and their newer IT tools can apply here (data mining, pattern extraction, cognitive AI tooling).

Physics Based “Internal Explanatory” Models

What are the internal interactions of the System of Interest, and how do they combine to cause/explain the behavior that is externally visible as interactions with external actors?

Special interests: The hard sciences physical laws, and how they can be used to explain the externally visible behavior of the System of Interest. Physical Scientists and models from their disciplines can apply here.

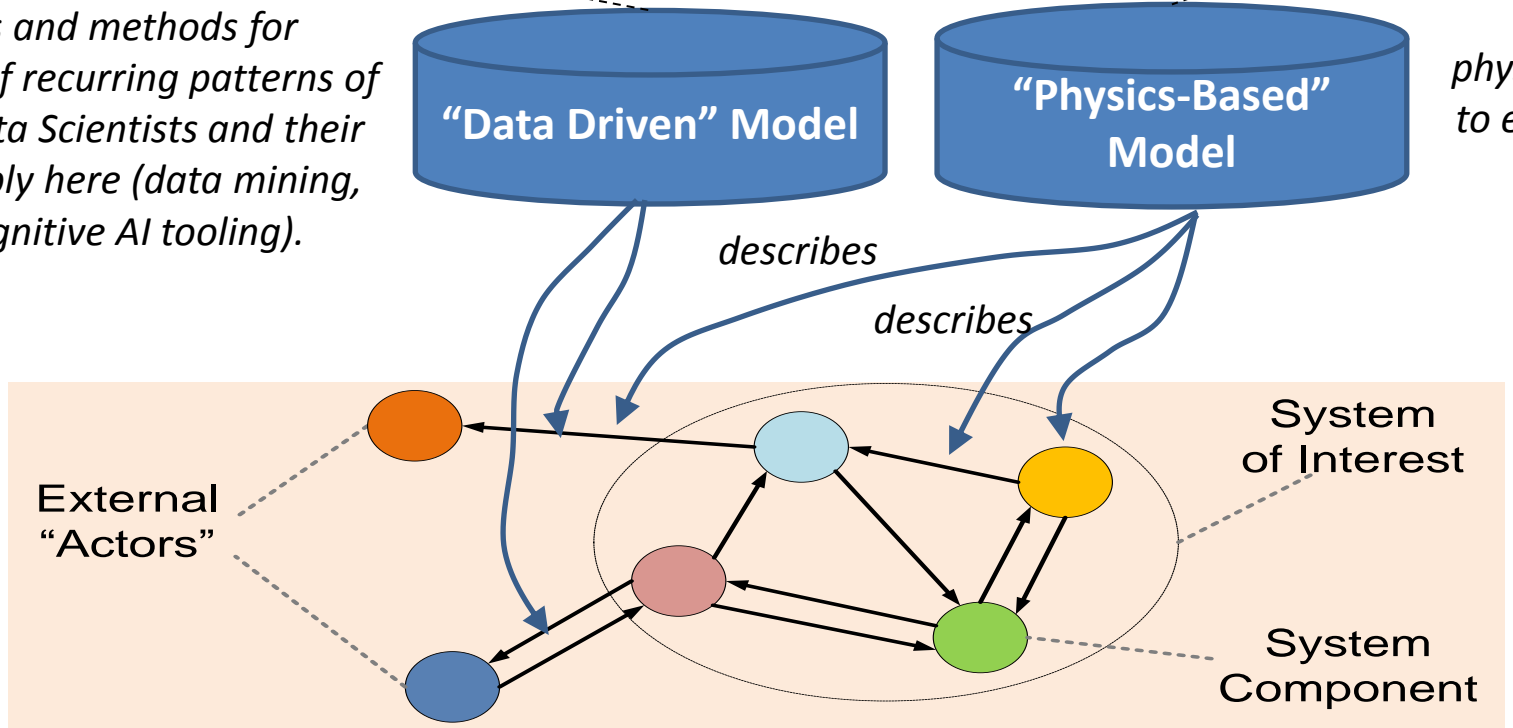

When expressed in S*Metamodel framework, the distinction and relationships of these two types of models becomes explicitly clear. It can be seen that this distinction retraces the history of the physical sciences, but with the latest tools. Remember the centuries-earlier studies of the night skies for patterns in the motion of stars and planets, followed later by the explanatory models of Newton and others.

The Opportunity for ASME and INCOSE

- INCOSE has a parent society-level initiative supporting the acceleration of the transformation of Systems Engineering to a model-based discipline:
 - The system models of interest to the INCOSE community are broader than the computational models of interest in the ASME Model V&V standardization effort—but the latter are a key subset of the former.
 - Moreover, many of the key ideas of Model V&V apply to that broader class of models, beginning with the concepts of model V&V itself, the issues of model life cycle management, concepts of data-driven and physics-based models, and others.
- Bill Schindel, co-chair of the INCOSE MBSE Patterns Working Group, joined ASME earlier in 2016, and has offered to join the Model Life Cycle Management sub-team (chaired by Joe Hightower, Boeing) of the ASME VV50 standards committee.
 - Bill has invited Joe to address the INCOSE MBSE Workshop at the International Workshop to be held in late January, 2017, in LA, concerning ASME VV 50.
 - Bill has also suggested that Joe consider joining or collaborating with the Model Management Working Group of INCOSE, which has related interests to Joe's.
- Opportunity for INCOSE and ASME to collaborate on their common interests:
 - The V and V of models (including general system models as well as computational)
 - The management of models over their life cycles
 - How the V&V of models fits into the larger system life cycle framework of ISO15288.
 - INCOSE IN Chapter supporting set up of an Indiana-based Virtual Verification Institute, including Additive Manufacturing applications.
- If the above prove to be of interest down the road, INCOSE also has a history of formalizing collaboration relationships with other organizations, use of Memoranda of Understanding, etc. – but usually after we have interested people active.

Nov. 7-8, 2016, ASME V V 50 Meeting Topical Highlights

- Hosted at GE Global Research, Schenectady, NY
- Approximately 23 attendees, plus 4 remote
- Chair: Sudarsan Rachuri, Pgm. Mgr., DOE Smart Manufacturing, Institute
- Vice-Chair: Mark Bennett, Pgm. Mgr., AFRL Manufacturing Technology Division
- ASME: Marian Heller, Steve Weinman, Dean Bartles
- Participants included: DOE, NIST, SWRI, AFRL, UL, MIT, Vanderbilt, Honeywell, GE, Boeing, Deere, ICTT
- GE's Brilliant Factory approach, use cases, challenges, review and tour of GE additive manufacturing and smart manufacturing facilities
- DOE Advanced Manufacturing Office focal issues include energy, clean energy processes, IT
- Plans for May meeting, at annual V&V Symposium

Nov. 7-8, 2016, ASME V V 50 Meeting Topical Highlights

- ASME Model V&V approach,
- data driven versus physics based models,
- standards teams and activities,
- membership types and expectations,
- sub-teams, including terminology, concepts taxonomy, model life cycle (Bill Schindel joined)
- connection to other ASME model VV committees (solid mechanics, fluid dynamics and heat transfer, nuclear, medical devices)
- manufacturing types coverage by committees,
- connection of product design models to manufacturing models,
- use cases,
- potential INCOSE-ASME collaboration,
- ASME model-based enterprise committee,
- types of ASME publications,
- levels of abstraction,
- ASME position on examples not in standards,
- ASTM library of unit operations,
- strategy for engaging software suppliers,
- PMML, CRISP-DM,
- NAS/NAE reports,
- special modeling challenges of additive manufacturing

References

- ASME Model V&V committees, draft documents
<https://cstools.asme.org/csconnect/CommitteePages.cfm?Committee=100003367>

VV50 Committee Leadership



- Chair: Sudarsan Rachuri, Pgm. Mgr., DOE Smart Manufacturing, Institute



- Vice-Chair: Mark Bennett, Pgm. Mgr., AFRL Manufacturing Technology Division

Vision for a Practical Aid to Model Community

- In establishing model credibility, a computational model is verified and validated:
 - With respect to not just the system it represents, but also the Model Requirements, specifying the intended use and characteristics of that model.
- This vision is to make the generation of those Model Requirements easier, more complete, and more successful than would otherwise be the case—using the Model VVUQ Pattern.

Vision for a Practical Aid to Model Community

- Vision of a guideline that includes a practical pattern for the efficient and effective planning and generation of computational models that have a higher likelihood of VVUQ and successful service.
- The smallest set of ideas necessary to achieve that goal.
- Makes use of ideas used in Pattern-Based Systems Engineering, a form of MBSE, for configurable models:

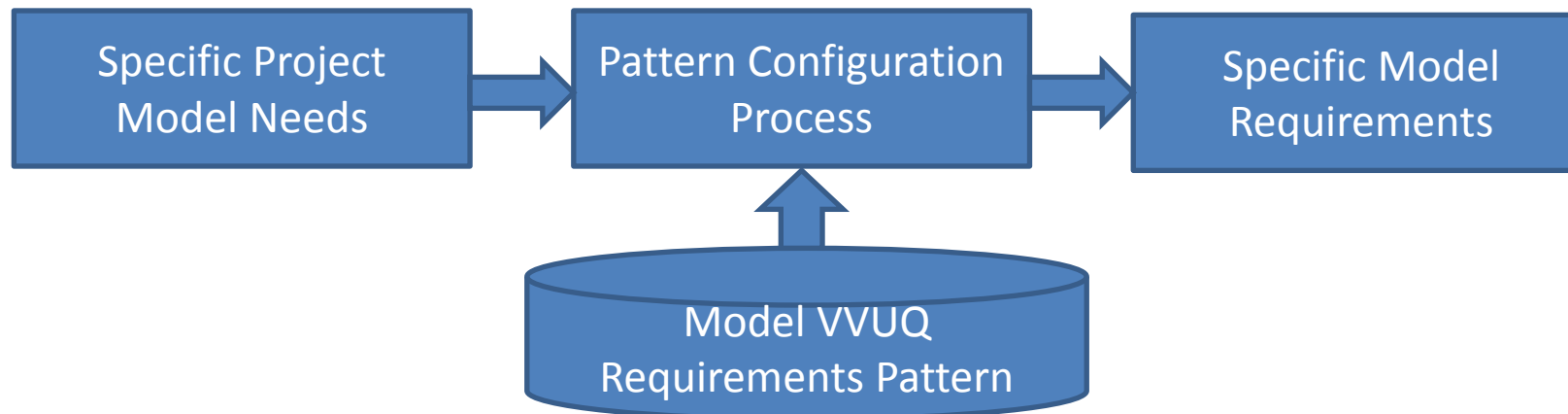

Vision for a Practical Aid to Model Community

- The foundation of this capability are the computational model's Stakeholder Features and the computational model's Requirements . . .

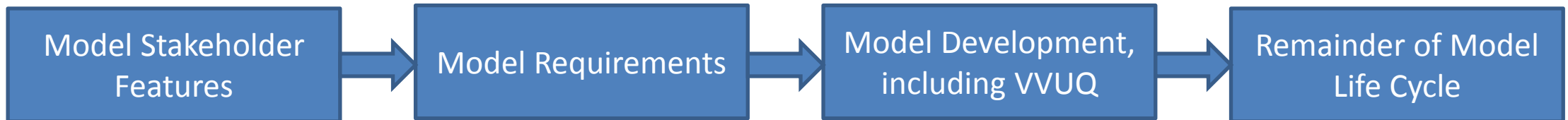

Stakeholders for Models

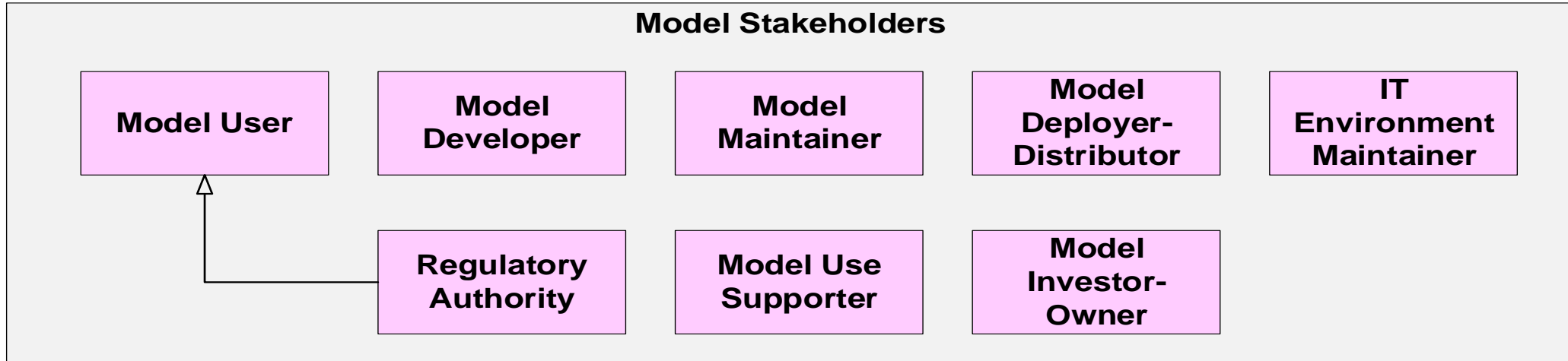

Model Stakeholder Type	Definition
Model User	A person, group, or organization that directly uses a model for its agreed upon purpose. May include technical specialists, non-technical decision-makers, customers, supply chain members, regulatory authorities, or others.
Model Developer	A person who initially creates a model, from conceptualization through implementation, validation, and verification, including any related model documentation. Such a person may or may not be the same as one who subsequently intains the model.
Model Maintainer	A person who maintains and updates a model after its initial development. In effect, the model maintainer is a model developer after the initial release of a model.
Model Deployer-Distributor	A person or organization that distributes and deploys a model into its intended usage environment, including transport and installation, through readiness for use.
Model Use Supporter	A person who supports or assists a Model User in applying a model for its intended use. This may include answering questions, providing advice, addressing problems, or other forms of support.
Regulatory Authority	An organization that is responsible for generating or enforcing regulations governing a domain.
Model Investor-Owner	A person or organization that invests in a model, whether through development, purchase, licenses, or otherwise, expecting a benefit from that investment.
IT Environment Maintainer	A person or organization that maintains the IT environment utilized by a computational model.

Computational Model Feature Groups: Configurable for Specific Models

Model Identity and Focus

Identifies the main subject or focus of the model.

Model Utility

Describes the intended use, user, utility, and value of the model.

Model Scope and Content

Describes the scope of content of the model.

Model Credibility

Describes the credibility of the model.

Model Life Cycle Management

Describes the related model life cycle management capabilities.

Model Representation

Describes the representation used by the model.

Computational Model Feature Groups: 27 Features, in 6 Feature Groups, Configurable for Specific Models

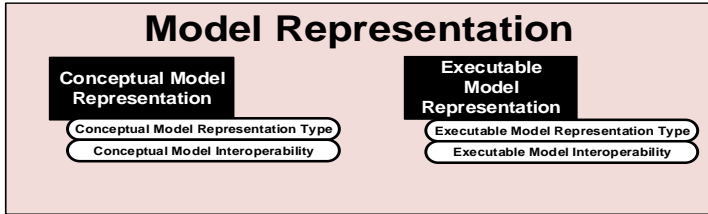
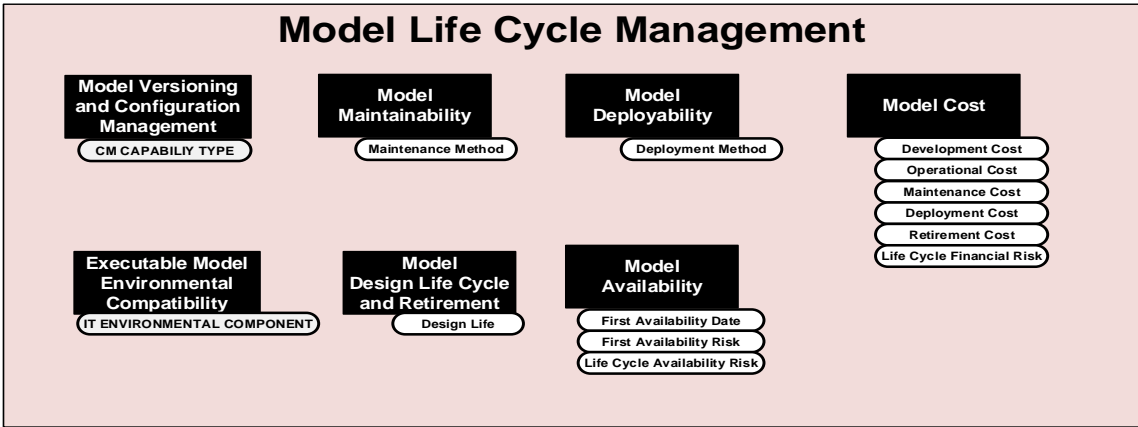
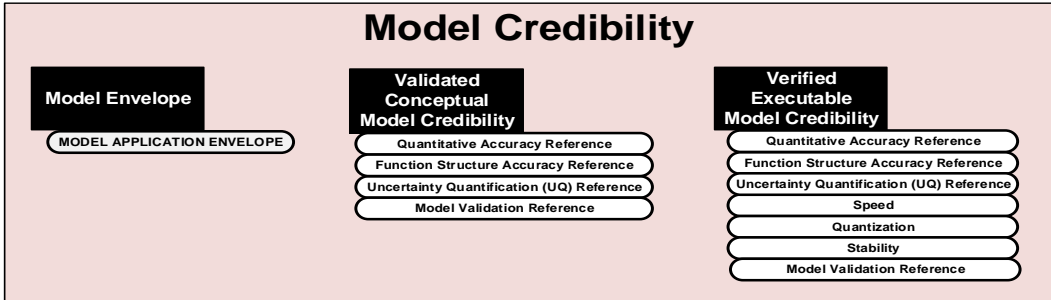
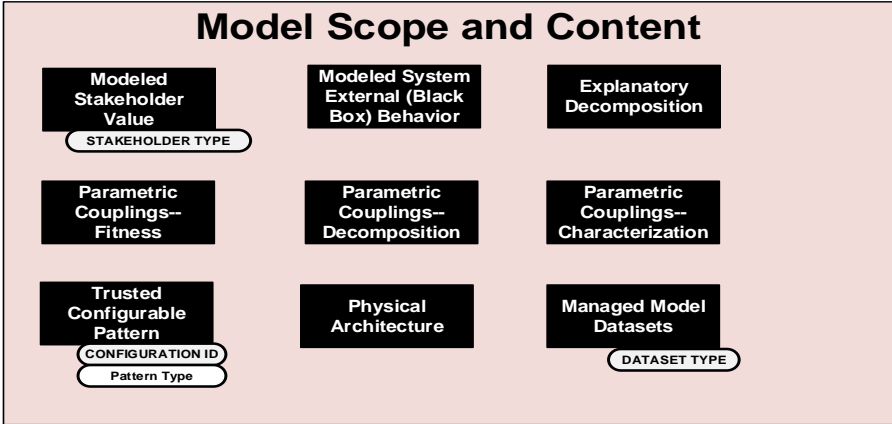
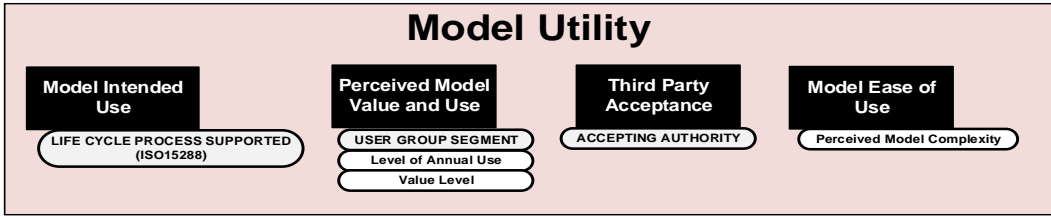
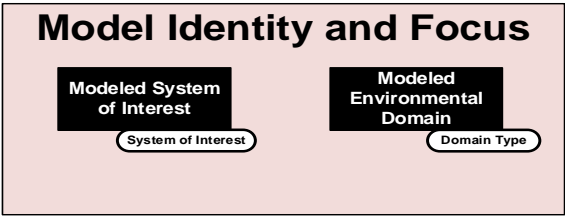

Computational Model Feature Groups: Configurable for Specific Models

- The Stakeholder Features are configurable Stakeholder expectations, intentions, and valued aspects for a computational model:
 - These can be “configured” like Lego[®] blocks, as a form of checklist to rapidly create the stakeholder-level expectations for a computational model.
 - And from them, the more technical Requirements for the model follow.

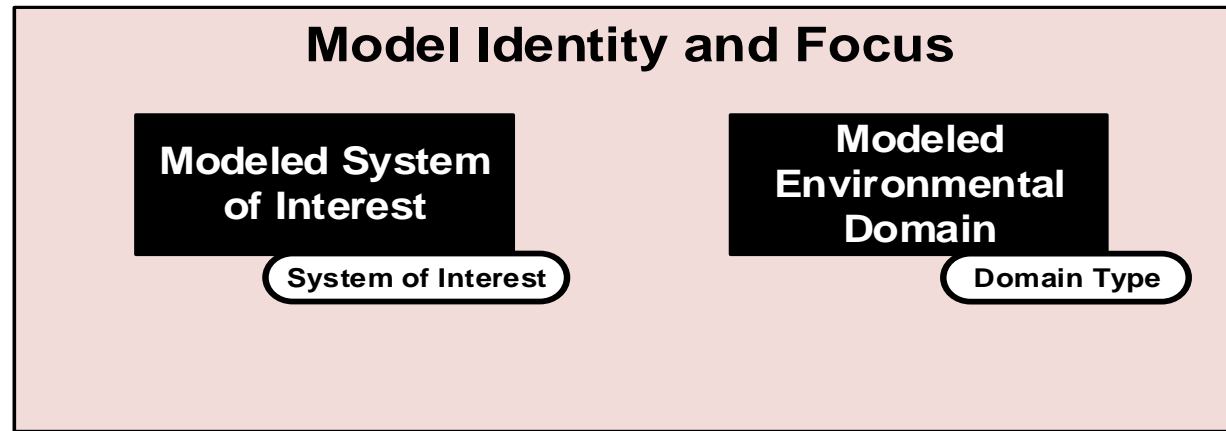

Feature Group	Feature Name	Feature Definition	Feature Attribute	Attribute Definition	Feature Stakeholder							Model Type	
					Model User	Model Developer	Model Maintainer	Mdl Deployer-Distributor	Model Use Supporter	Regulatory Authority	Mdl Investor-Owner	Physics Based	Data Driven
Identifies the main subject or focus of the model													
Model Identity and Focus	Modeled System of Interest	Identifies the type of system this model describes.	System of Interest	Name of system of interest, or class of systems of interest	X					X	X	X	X
	Modeled Environmental Domain	Identifies the type of external environmental domain(s) that this model includes.	Domain Type(s)	Name(s) of modeled domains (manufacturing, distribution, use, etc.)	X					X	X	X	X

In this V&V50 work, the Modeled System of Interest above typically focuses on a manufacturing process (including material in process), related to some manufactured product.

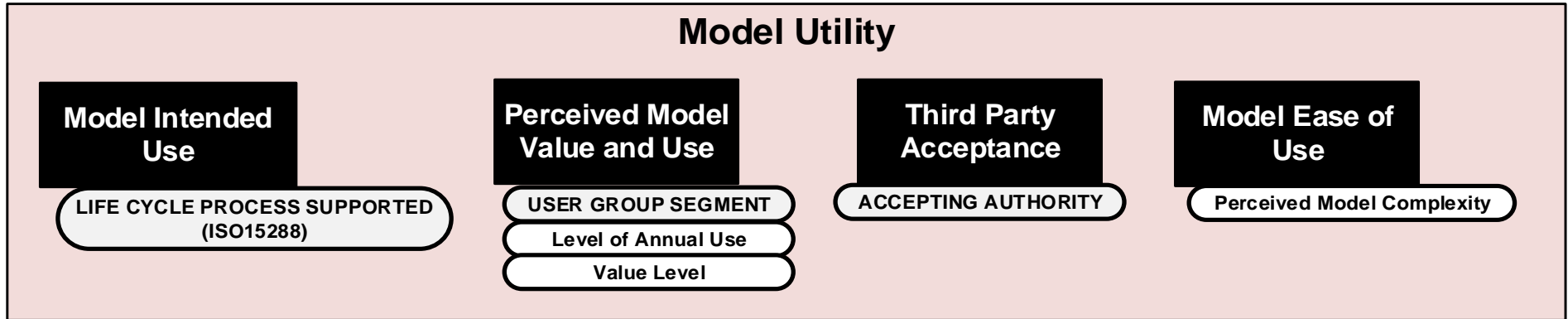

Feature Group	Feature Name	Feature Definition	Feature Attribute	Attribute Definition	Feature Stakeholder							Model Type		
					Model User	Model Developer	Model Maintainer	Mdl Deployer-Distributor	Model Use Supporter	Regulatory Authority	Mdl Investor-Owner	Physics Based	Data Driven	
Describes the intended use, utility, and value of the model														
Model Utility	Model Intended Use	The intended purpose(s) or use(s) of the model.	Life Cycle Process Supported	The intended life cycle management process to be supported by the model, from the ISO15288 process list. More than one value may be listed.	X						X	X	X	X
	Perceived Model Value and Use	The relative level of value ascribed to the model, by those who use it for its stated purpose.	User Group Segment	The identify of using group segment (multiple)	X					X	X	X	X	X
			Level of Annual Use	The relative level of annual use by the segment	X					X	X	X	X	X
			Value Level	The value class associated with the model by that segment	X					X	X	X	X	X
	Third Party Acceptance	The degree to which the model is accepted as authoritative, by third party regulators, customers, supply chains, and other entities, for its stated purpose.	Accepting Authority	The identity (may be multiple) of regulators, agencies, customers, supply chains, accepting the model	X					X	X	X	X	X
Model Ease of Use	The perceived ease with which the model can be used, as experienced by its intended users	Perceived Model Complexity	High, Medium Low	X					X		X	X	X	

Model Scope and Content

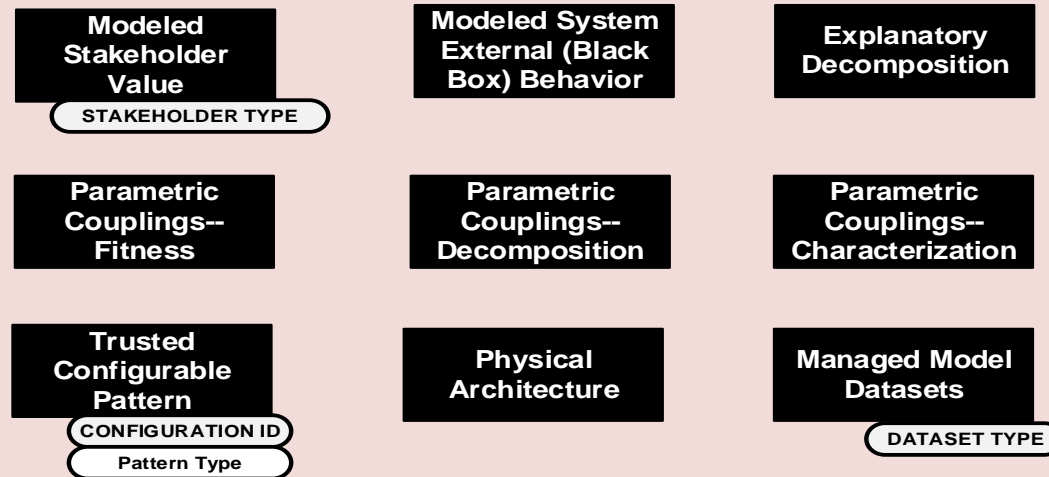

Feature Group	Feature Name	Feature Definition	Feature Attribute	Attribute Definition	Feature Stakeholder							Model Type	
					Model User	Model Developer	Model Maintainer	Mdl Deployer-Distributor	Model Use Supporter	Regulatory Authority	Mdl Investor-Owner	Physics Based	Data Driven
Describes the scope of content of the model													
Model Scope of Content	Modeled Stakeholder Value	The capability of the model to describe fitness or value of the System of Interest, by identifying its stakeholders and modeling the related Stakeholder Features.	Stakeholder Type	Classes of covered stakeholders (may be multiple)	X					X	X	X	X
	Modeled System External (Black Box) Behavior	The capability of the model to represent the objective external ("black box") technical behavior of the system, through significant interactions with its environment, based on modeled input-output exchanges through external interfaces, quantified by technical performance measures, and varying behavioral modes.			X					X		X	X
	Explanatory Decomposition	The capability of the model to represent the decomposition of its external technical behavior, as explanatory internal ("white box") internal interactions of decomposed roles, further quantified by internal technical performance measures, and varying internal behavioral modes.			X					X		X	
	Physical Architecture	The capability of the model to represent the physical architecture of the system of interest. This includes identification of its major physical components and their architectural relationships.			X					X		X	

Model Scope and Content

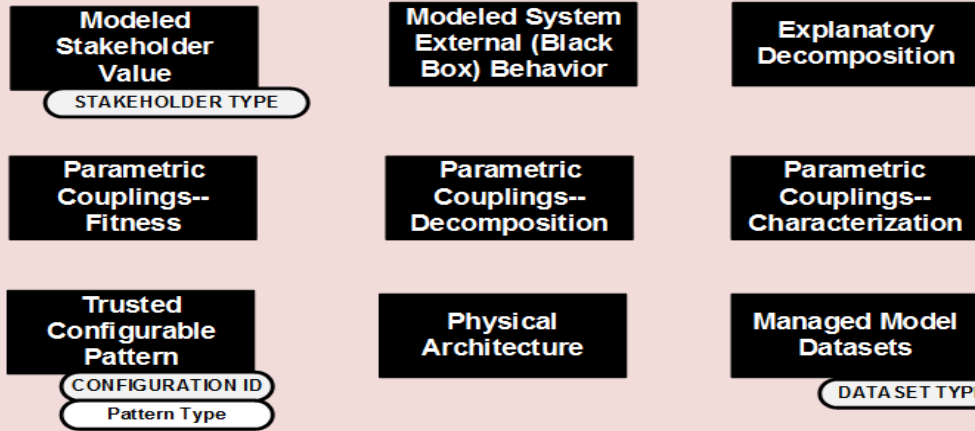

Feature Group	Feature Name	Feature Definition	Feature Attribute	Attribute Definition	Feature Stakeholder							Model Type	
					Model User	Model Developer	Model Maintainer	Mdl Deployer-Distributor	Model Use Supporter	Regulatory Authority	Mdl Investor-Owner	Physics Based	Data Driven
Describes the scope of content of the model													
	Parametric Couplings--Fitness	The capability of the model to represent quantitative (parametric) couplings between stakeholder-valued measures of effectiveness and objective external black box behavior performance measures.			X					X		X	X
	Parametric Couplings--Decomposition	The capability of the model to represent quantitative (parametric) couplings between objective external black box behavior variables and objective internal white box behavior variables.			X					X		X	X
	Parametric Couplings--Characterization	The capability of the model to represent quantitative (parametric) couplings between objective behavior variables and physical identity (material of construction, part or model number).			X					X		X	
	Managed Model Datasets	The capability of the model to include managed datasets for use as inputs, parametric characterizations, or outputs	Dataset Type	The type(s) of data sets (may be multiple)	X		X			X		X	X
	Trusted Configurable Pattern	The capability of the model to serve as a configurable pattern, representing different modeled system configurations across a common domain, spreading the cost of establishing trusted model frameworks across a community of applications and configurations	Configuration ID	A specific system of interest configuration within the family that the pattern framework can represent.	X		X			X	X	X	X
			Pattern ID	The identifier of the trusted configurable pattern	X		X				X	X	X

Model Scope and Content

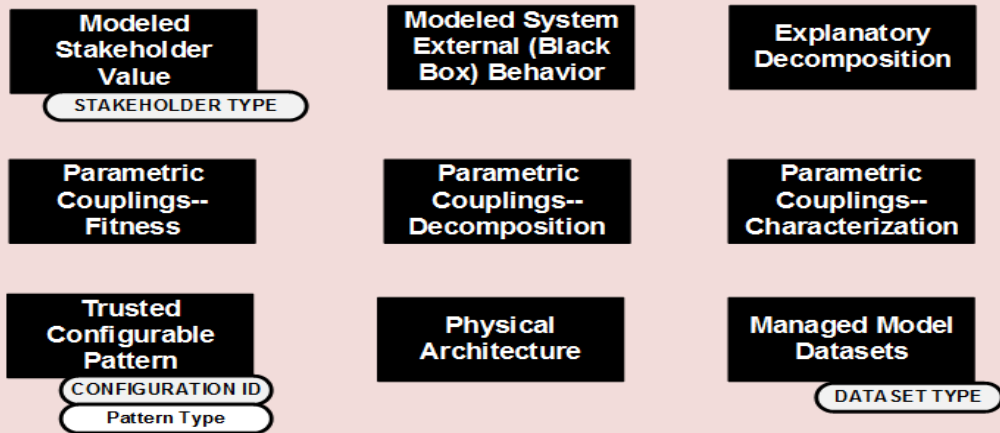

Of special importance to the economics of trust and VUQ

Feature Definition	Feature Attribute	Attribute Definition	Feature Stakeholder							Model Type	
			Model User	Model Developer	Model Maintainer	Mdl Deployer-Distributor	Model Use Supporter	Regulatory Authority	Mdl Investor-Owner	Physics Based	Data Driven
Describes the scope of content of the model											
Parametric Couplings--Fitness	The capability of the model to represent quantitative (parametric) couplings between stakeholder-valued measures of effectiveness and objective external black box behavior performance measures.		X					X		X	X
Parametric Couplings--Decomposition	The capability of the model to represent quantitative (parametric) couplings between objective external black box behavior variables and objective internal white box behavior variables.		X					X		X	X
Parametric Couplings--Characterization	The capability of the model to represent quantitative (parametric) couplings between objective behavior variables and physical identity (material of construction, part or model number).		X					X		X	
Managed Model Datasets	The capability of the model to include managed datasets for use as inputs, parametric characterizations, or outputs	Dataset Type	X		X			X		X	X
Trusted Configurable Pattern	The capability of the model to serve as a configurable pattern, representing different modeled system configurations across a common domain, spreading the cost of establishing trusted model frameworks across a community of applications and configurations.	Configuration ID	X		X			X	X	X	X
		Pattern ID	X		X			X	X	X	X

Model Credibility

Model Envelope

MODEL APPLICATION ENVELOPE

Validated Conceptual Model Credibility

Quantitative Accuracy Reference

Function Structure Accuracy Reference

Uncertainty Quantification (UQ) Reference

Model Validation Reference

Verified Executable Model Credibility

Quantitative Accuracy Reference

Function Structure Accuracy Reference

Uncertainty Quantification (UQ) Reference

Speed

Quantization

Stability

Model Validation Reference

Feature Group	Feature Name	Feature Definition	Feature Attribute	Attribute Definition	Feature Stakeholder							Model Type	
					Model User	Model Developer	Model Maintainer	Mdl Deployer-	Model Use Supporter	Regulatory Authority	Mdl Investor-	Physics Based	Data Driven
Describes the credibility of the model													
	Model Envelope	The capability of the model to meet its Model Credibility requirements over a stated range (envelope) of dynamical inputs, outputs, and parameter values.	Model Application Envelope	The range over which the model is intended for use.	X		X			X	X	X	X
	Validated Conceptual Model Credibility	The validated capability of the conceptual portion of the model to represent the System of Interest, with acceptable Credibility.	Quantitative Accuracy Reference	The specification reference describing the quantitative accuracy of the conceptual model compared to the system of interest.	X					X	X	X	X
Function Structure Accuracy Reference			The specification reference describing the structural (presence or absence of behaviors) accuracy of the conceptual model compared to the system of interest.	X		X			X	X	X	X	
Uncertainty Quantification (UQ) Reference			The specification reference describing the degree of uncertainty of the Credibility of the conceptual model to the system of interest.	X		X			X	X	X	X	
Model Validation Reference			The reference documenting the validation of the conceptual model's Credibility to the system of interest.	X		X			X	X	X	X	

Model Credibility

Model Envelope

MODEL APPLICATION ENVELOPE

Validated
Conceptual
Model Credibility

- Quantitative Accuracy Reference
- Function Structure Accuracy Reference
- Uncertainty Quantification (UQ) Reference
- Model Validation Reference

Verified
Executable
Model Credibility

- Quantitative Accuracy Reference
- Function Structure Accuracy Reference
- Uncertainty Quantification (UQ) Reference
- Speed
- Quantization
- Stability
- Model Validation Reference

Feature Group	Feature Name	Feature Definition	Feature Attribute	Attribute Definition	Feature Stakeholder							Model Type				
					Model User	Model Developer	Model Maintainer	Mdl Deployer-	Model Use Supporter	Regulatory Authority	Mdl Investor-	Physics Based	Data Driven			
Model Credibility	Verified Executable Model Credibility	The verified capability of the executable portion of the model to represent the System of Interest, with acceptable Credibility.	Quantitative Accuracy Reference	The specification reference describing the quantitative accuracy of the executable model to the conceptual model.	X		X				X	X	X	X		
			Structural Accuracy Reference	The specification reference describing the structural (presence or absence of elements) accuracy of the executable model to the conceptual model.	X		X				X	X	X	X	X	
			Uncertainty Quantification (UQ) Reference	The specification reference describing the degree of uncertainty of the Credibility of the executable model to the conceptual model.	X		X				X		X	X	X	X
			Speed	The specification reference describing the execution run time (speed) for the executable model.	X		X				X	X	X	X	X	X
			Quantization	The specification reference describing the quantization error of the executable model.	X		X				X	X	X	X	X	X
			Stability	The specification reference describing the level of stability of the accuracy and uncertainty of the executable model error characteristics.	X		X				X	X	X	X	X	X
			Model Validation Reference	The reference documenting the verification of the executable model's Credibility to the conceptual model.	X		X				X	X	X	X	X	X

Model Life Cycle Management

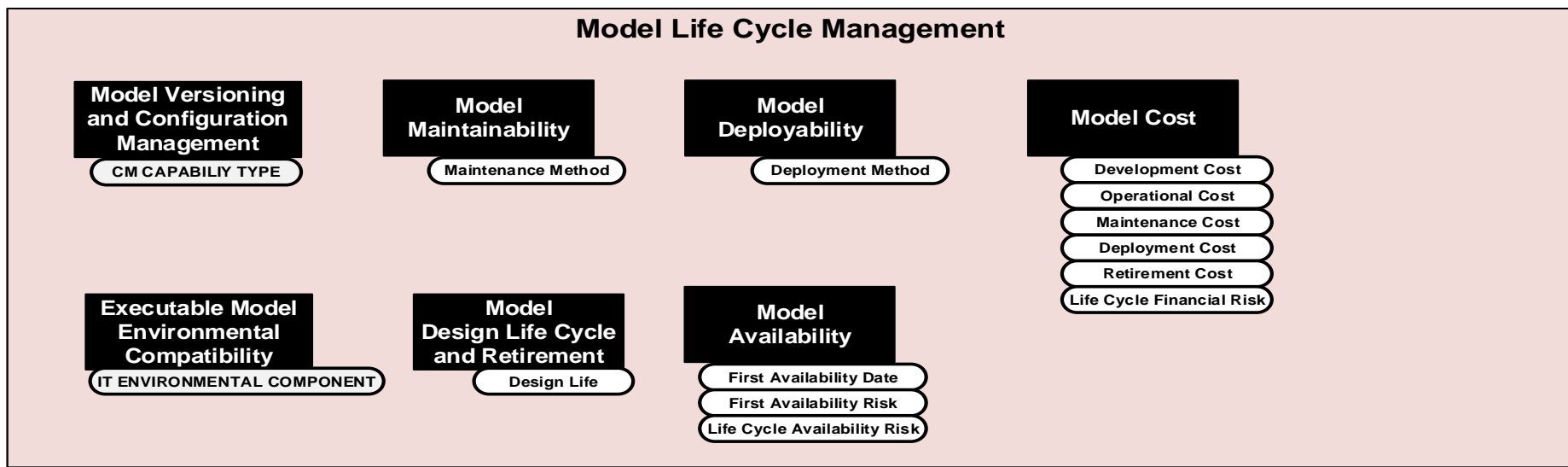

Feature Group	Feature Name	Feature Definition	Feature Attribute	Attribute Definition	Feature Stakeholder							Model Type	
					Model User	Model Developer	Model Maintainer	Mdl Deployer-Distributor	Model Use Supporter	Regulatory Authority	Mdl Investor-Owner	Physics Based	Data Driven
Describes related model life cycle management capabilities													
Model Life Cycle Management	Model Versioning and Configuration Management	The capability of the model to provide for version and configuration management.	CM Capability Type	The type(s) of CM capabilities included (may be multiple)	X		X			X		X	X
	Executable Model Environmental Compatibility	The capability of the model to be compatibly supported by specified information technology environment(s), indicating compatibility, portability, and interoperability.	IT Environmental Component	The type(s) of IT environments or standards supported	X		X			X		X	X
	Model Design Life and Retirement	The capability of the model to be sustained over an indicated design life, and retired on a planned basis.	Design Life	The planned retirement date	X		X			X		X	X
	Model Maintainability	The relative ease with which the model can be maintained over its intended life cycle and use, based on capable maintainers, availability of effective model documentation, and degree of complexity of the model	Maintenance Method	The type of maintenance methodology used to maintain the model's capability and availability for the intended purposes over the intended life cycle.	X		X			X	X	X	X
	Model Deployability	The capability of the model to support deployment into service on behalf of intended users, in its original or subsequent updated versions	Deployment Method	The type of method used to deploy (possibly in repeating cycles) the model into its intended use environment.	X			X			X	X	X

Model Life Cycle Management

Model Versioning and Configuration Management

CM CAPABILITY TYPE

Model Maintainability

Maintenance Method

Model Deployability

Deployment Method

Model Cost

- Development Cost
- Operational Cost
- Maintenance Cost
- Deployment Cost
- Retirement Cost
- Life Cycle Financial Risk

Executable Model Environmental Compatibility

IT ENVIRONMENTAL COMPONENT

Model Design Life Cycle and Retirement

Design Life

Model Availability

- First Availability Date
- First Availability Risk
- Life Cycle Availability Risk

Feature Group	Feature Name	Feature Definition	Feature Attribute	Attribute Definition	Feature Stakeholder							Model Type		
					Model User	Model Developer	Model Maintainer	Mdl Deployer-Distributor	Model Use Supporter	Regulatory Authority	Mdl Investor-Owner	Physics Based	Data Driven	
Describes related model life cycle management capabilities														
Model Life Cycle Management	Model Cost	The financial cost of the model, including development, operating, and maintenance cost	Development Cost	The cost to develop the model, including its validation and verification, to its first availability for service date		X						X	X	X
			Operational Cost	The cost to execute and otherwise operate the model, in standardized execution load units	X							X	X	X
			Maintenance Cost	The cost to maintain the model			X					X	X	X
			Deployment Cost	The cost to deploy, and redeploy updates, per cycle				X				X	X	X
			Retirement Cost	The cost to retire the model from service, in a planned fashion	X							X	X	X
			Life Cycle Financial Risk	Risk to the overall life cycle cost of the model								X	X	X
	Model Availability	The degree and timing of availability of the model for its intended use, including date of its first availability and the degree of ongoing availability thereafter.	First Availability Date	Date when version will first be available	X							X	X	X
			First Availability Risk	Risk to the scheduled date of first availability	X							X	X	X
			Life Cycle Availability Risk	Risk to ongoing availability after introduction	X							X	X	X

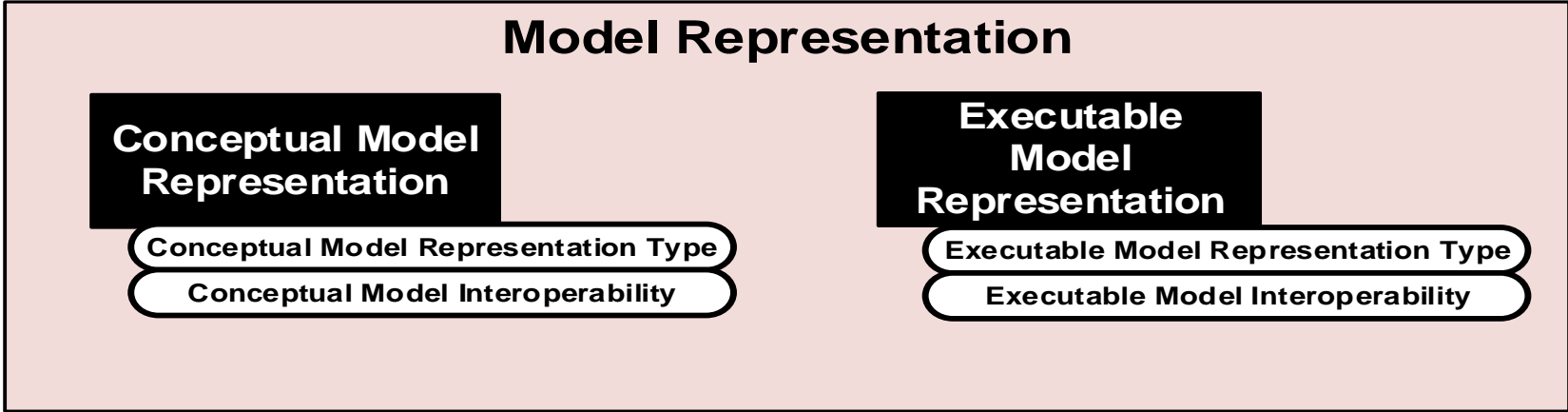

Feature Group	Feature Name	Feature Definition	Feature Attribute	Attribute Definition	Feature Stakeholder							Model Type	
					Model User	Model Developer	Model Maintainer	Mdl Deployer-Distributor	Model Use Supporter	Regulatory Authority	Mdl Investor-Owner	Physics Based	Data Driven
Identifies the type of representation used by the model													
Model Representation	Conceptual Model Representation	The capability of the conceptual portion of the model to represent the system of interest, using a specific type of representation.	Conceptual Model Representation Type	The type of conceptual modeling language or metamodel used.	X		X			X		X	X
			Conceptual Model Interoperability	The degree of interoperability of the conceptual model, for exchange with other environments	X		X			X		X	X
	Executable Model Representation	The capability of the executable portion of the model to represent the system of interest, using a specific type of representation	Executable Model Representation Type	The type of executable modeling language or metamodel used.	X		X			X		X	X
			Executable Model Interoperability	The degree of interoperability of the executable model, for exchange with other environments	X		X			X		X	X

Generation of Model Stakeholder Features

- The Model Stakeholder Feature Pattern is configured for a specific project by populating or depopulating the pattern's generic Features, and setting the values of its Feature Attributes:

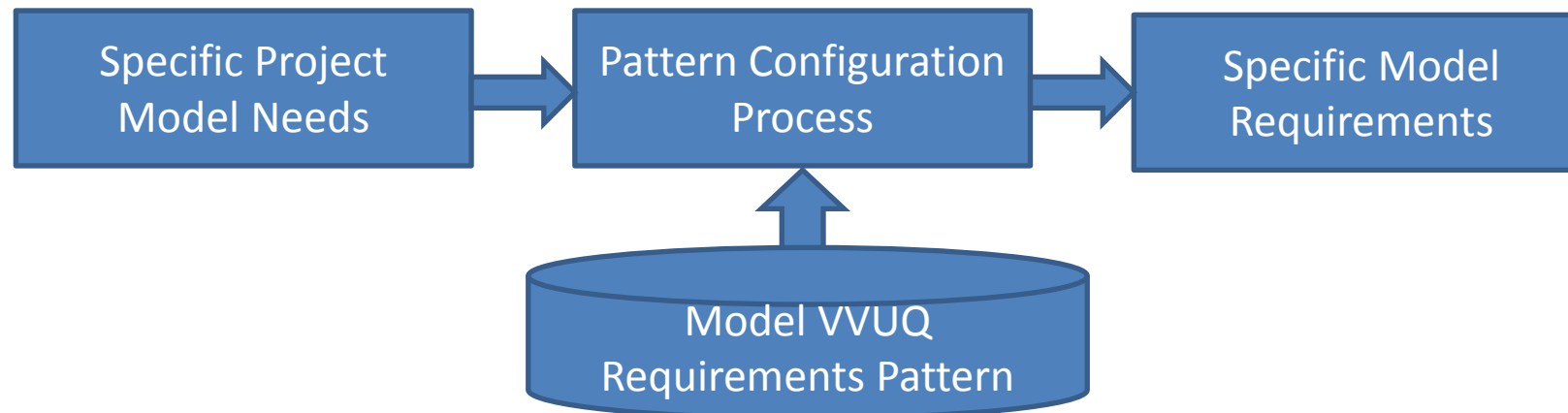

System Reference Boundaries: Computational Modeling Domain

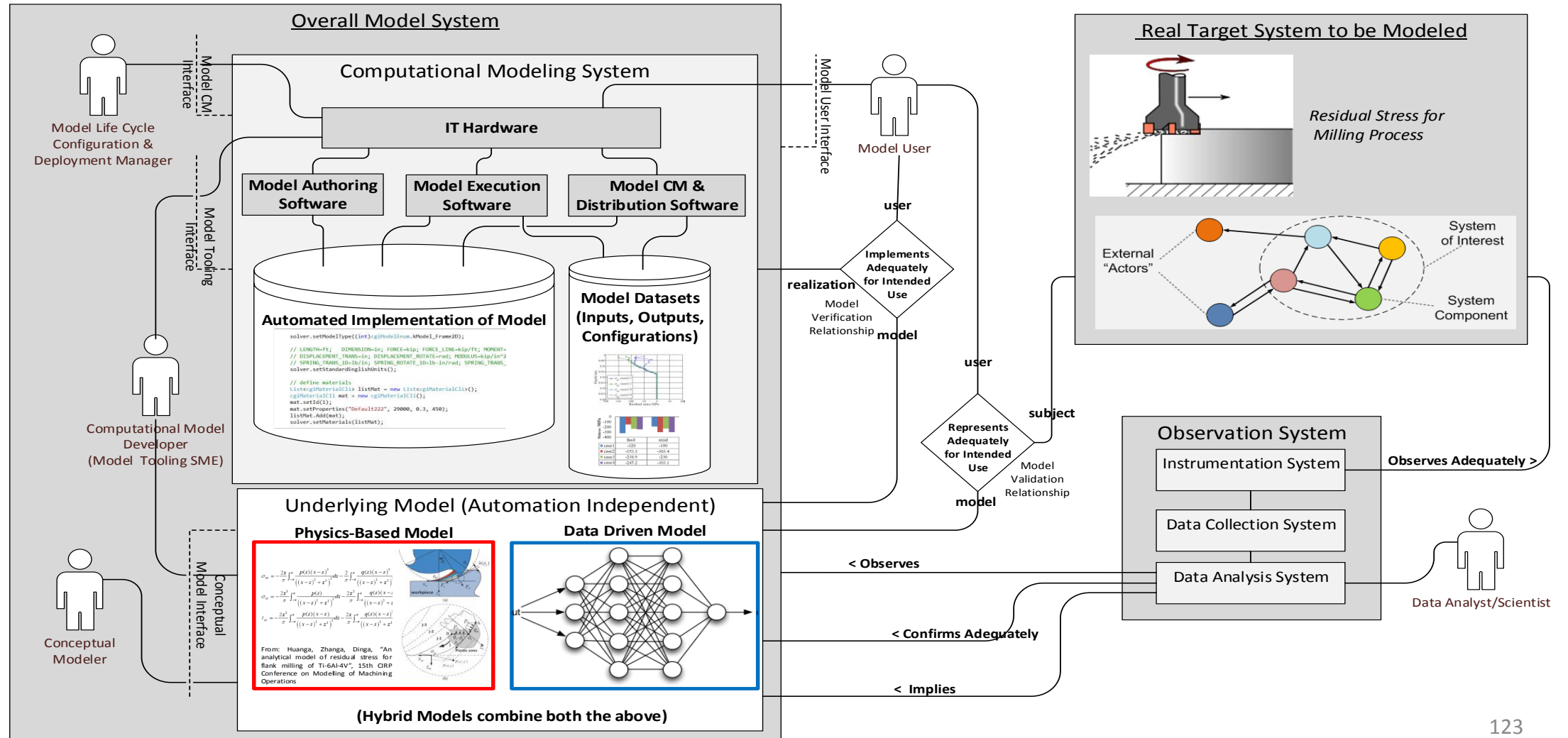

Requirements for Models

- Requirements for a specific computational model are the basis of subsequent validation and verification of the model.
- The Requirements for a computational model are implied by the Stakeholder Features (see above), but with more details configured into them.
- Approximately 75 configurable general Requirements for Models have been identified and traced to the Stakeholder Features, in the current draft of the Model VVUQ Pattern.
- After these have been further vetted and polished in this project, they provide a rapid start way to generate a high quality set of Model Requirements in a production project.

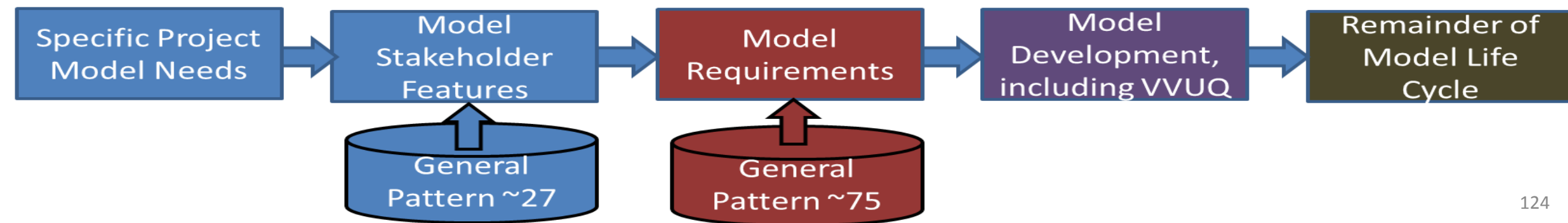

Requirements for Models: Example Extract

Requirement Group	Model Requirement Name	Model Requirement (configure further as needed)	Explanation, discussion
2.2 External Behavior Model			
	External Interfaces	The Model shall represent the external Input-Outputs exchanged during interactions with Domain Actors, and the external Interfaces through which they are exchanged.	Input-Outputs are flows of energy, force, mass, or information, exchanged during the interactions noted above. These flow through Interfaces. Examples of Interfaces include radiating or absorbing surfaces, mechanical connections or fasteners, hydraulic connections, electrical connectors, liquid-liquid or liquid-solid boundaries, keyboards, displays, chemically active interfaces, sensors, actuators, biologically active interfaces, etc.
	External Interactions	The model shall represent all the significant external interactions that the system of interest has with its listed environmental actors, listing which actors are involved in each interaction.	All behavior, and all the laws of the physical sciences, is in the context of Interactions, consisting of the exchange of energy, force, mass flow, or information, leading to state change in the interacting entities. Representing Interactions is accordingly central to Physics-Based Models. In addition, Data-Driven Models represent discovered and compressed description of the external appearance of those interactions, even though no underlying physics-based cause may be included. So, both types of models require that the models include identification of all the <u>external</u> interactions that the subject system has with its environmental actors. "Significant" in this requirement is always evaluated in terms of its impact on the modeled system stakeholder measures of effectiveness. Note that this requirement is not about interactions that are internal to the system of interest. Those are only of interest for certain types of models, and covered in another section later below.
	Parasitics--External	The modeled external interactions shall include any parasitic aspects which arise from choice of internal design, materials, technologies, or solution approach but which were not otherwise required by the primary intended system purpose, where significant from a stakeholder perspective.	These are in principle a subset of the External Interactions referred to in the preceding section, but are noted here so that they are not overlooked. Some interactions that a system has with its environment may be "accidents" of its design, selected technology, or the environment itself. For example, a mechanical structural member (a part) may contribute parasitic or "stray" electrical capacitance that impacts the electronic behavior of the system. In engineered (human designed) systems, these interactions might be considered to fall in the category of "unintended" interactions, but they are just as real as those intended, and may have large technical and stakeholder impacts. Failure modes are a part of this behavior.
	Dynamical Variables--External	For each identified Interaction, the model shall include the dynamically changing quantities significant to the interaction, for both the System of Interest and the External Actors in the Interaction.	The external behavior Interactions identified above are further parameterized by technical Measures of Performance, providing numerical or other measures that quantify the external behavior of the system objectively, without regard to stakeholder-judged "goodness". Typical measures of this type include position, temperature, pressure, rates of change of those variables, mass flow rate, timing, or other technical measures. These parameters include the variables of physics and what technical instrumentation tries to measure. They are further divided into "fast changing dynamic variables" that describe system dynamics, and "slow changing static parameters" such as heat capacity, power ratings, mechanical dimensions or geometry, etc.
	Static Parameters--External	For each identified Interaction, the model shall include the static or slow changing quantities characterizing the system's performance of the interaction, for both the System of Interest and the External Actors in the Interaction.	

Backup, References

- From INCOSE/OMG MBSE Patterns Working Group

<http://www.incose.org/ChaptersGroups/WorkingGroups/transformational/mbse-patterns>

<http://www.omgwiki.org/MBSE/doku.php?id=mbse:patterns:patterns>

An Old Subject, Renewed

- Guidance on generating Requirements for any system is a decades-old subject, with lots of literature, so might seem to be settled.
- However, the rise of Model-Based Engineering (MBE, MBSE, etc.) has dramatically changed our understanding and related practices for the better, as we describe systems with the language of science and mathematics, not just structured prose alone.
- This has reminded us what all models, computational or otherwise, must tell us for purposes of engineering or science.

What Is the Smallest Model of a System?

William D. Schindel
 ICTT System Sciences
schindel@icct.com

Copyright © 2011 by William D. Schindel. Published and used by INCOSE with permission.

Abstract. How we represent systems is fundamental to the history of mathematics, science, and engineering. Model-based engineering methods shift the nature of representation of systems from historical prose forms to explicit data structures more directly comparable to those of science and mathematics. However, using models does not guarantee simpler representation--indeed a typical fear voiced about models is that they may be too complex.

Minimality of system representations is of both theoretical and practical interest. The mathematical and scientific interest is that the size of a system's "minimal representation" is one definition of its complexity. The practical engineering interest is that the size and redundancy of engineering specifications challenge the effectiveness of systems engineering processes. INCOSE thought leaders have asked how systems work can be made 10:1 simpler to attract a 10:1 larger global community of practitioners. And so, we ask: What is the smallest model of a system?

Introduction and Background: Size Matters!

Representation Size, Purpose, Traditions. This paper discusses possible (at least) upper bounds on the sizes of effective representations of systems, for systems engineering. Compared to traditional systems engineering approaches directly on scientific traditions for representing behavior as physical inter engineering is still young, and its connections to supporting sciences is still ex

Language and Compression. This subject may appear to be related to the I describe systems, and an interesting thread in the mathematical study of desc whether minimality is in a sense independent of language (Chaitin, Grunwald. In any case, systems modeling languages such as SysML® and its prede valuable assets for the movement to model-based methods (SysML Partners). is not the machinery of these specific modeling languages, but the systems id models must address. When used for system families (product lines, representation described here is subject to significant compression by the use turns out to provide powerful insights about approaches to major practical r size of SE descriptions and processes, and about ongoing future evolution of d over time. These dynamics also suggest that such patterns can be understood as the interaction rules of the systems engineering process are properly arranged.

Practical representation challenges of traditional systems engineering. Tr documentation of concept of operations (CONOPS), system requir specifications, failure mode and effects analysis (FMEA), test plans, maintenance procedures, and other task-specific system representations over t system can exceed thousands of pages. This does not encourage the enga

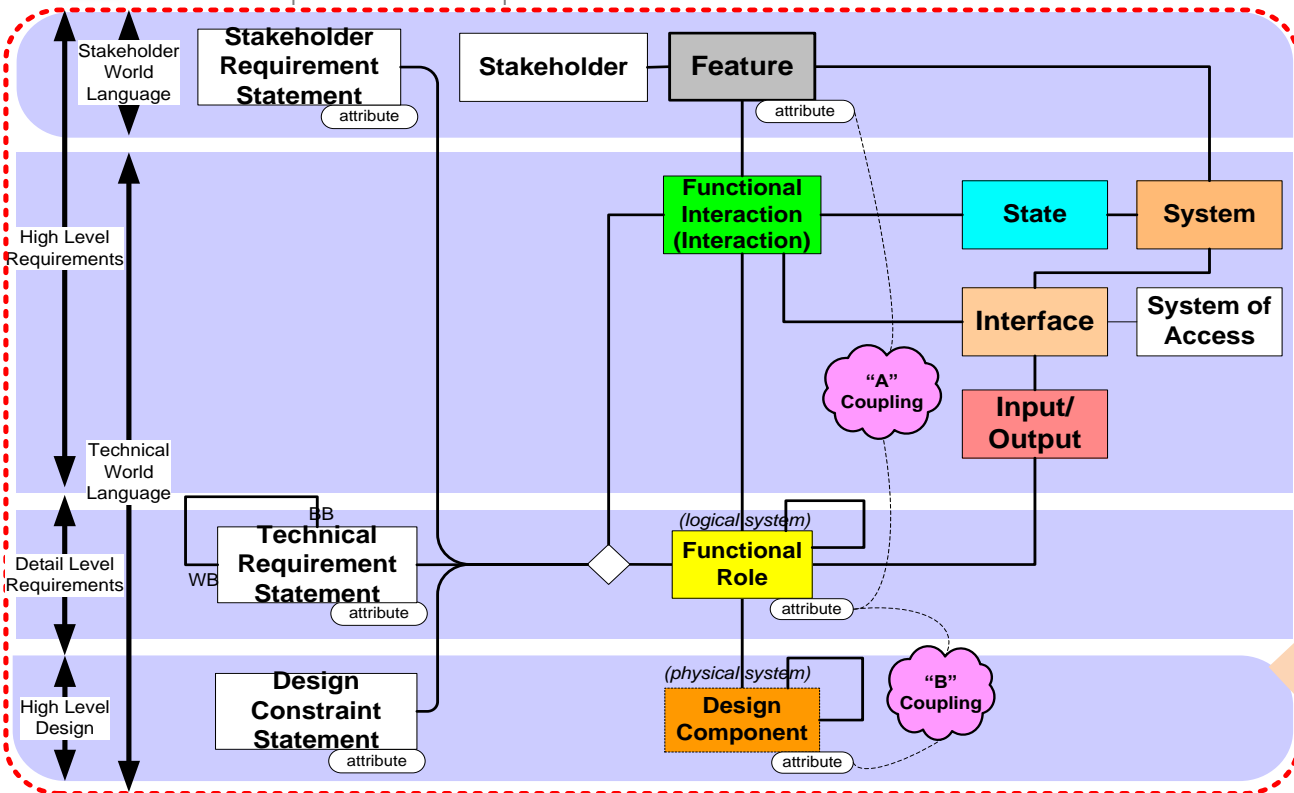

INCOSE 2005 Symposium "Best Paper" Award in Modeling and Tools

Requirements Statements Are Transfer Functions: An Insight from Model-Based Systems Engineering

William D. Schindel
 ICTT, Inc., and System Sciences, LLC
 100 East Campus Drive, Terre Haute, IN 47802
 812-232-2062 schindel@icct.com

Copyright © 2005 by William D. Schindel. Published and used by INCOSE with permission.

S* Metamodel --
 Summary

- A System is a set of interacting components:

- By “interact”, we mean exchanging energy, forces, mass flows, or information, resulting in changes of state:

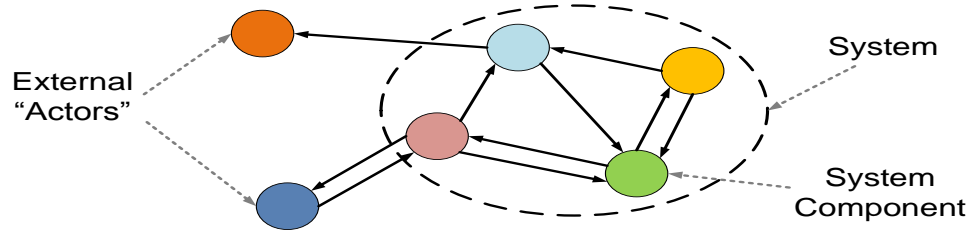

- So, a (Manufacturing or other) Process is a type of System (but not all Systems are such Processes):

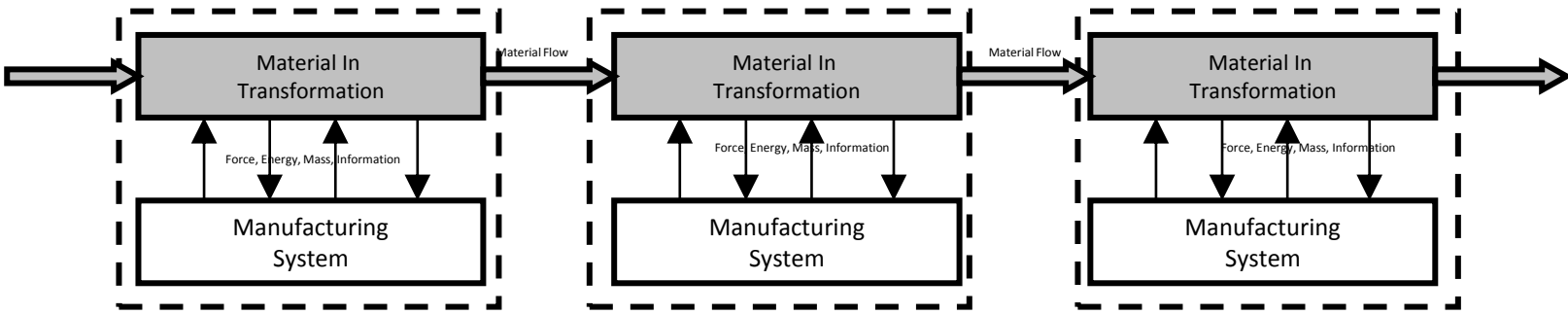

- The “Black Box” view of a system sees only its external behavior
- The “White Box” view of a system sees its internal interactions

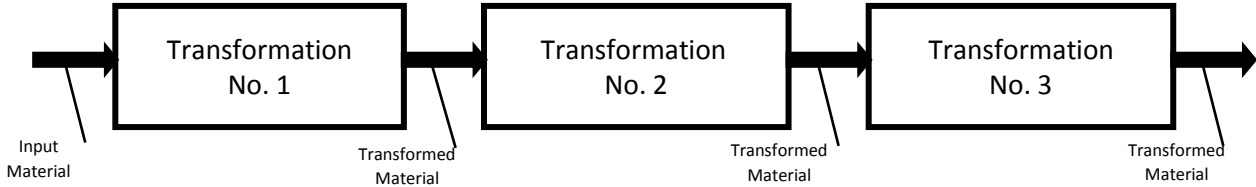

Physics-Based Model

- Predicts the external behavior of the System of Interest, visible externally to the external actors with which it interacts.
- Models internal physical interactions of the System of Interest, and how they combine to cause/explain externally visible behavior.
- Model has both external predictive value and phenomena-based internal-to-external explanatory value.
- Overall model may have high dimensionality.

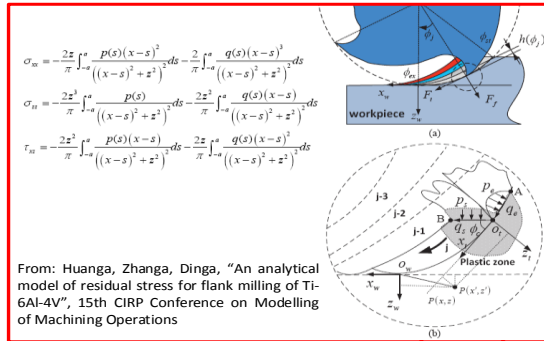

Data Driven Model

- Predicts the external behavior of the System of Interest, visible to the external actors with which it interacts.
- Model intermediate quantities may not correspond to internal or external physical parameters, but combine to adequately predict external behavior, fitting it to compressed relationships.
- Model has external predictive value, but not internal explanatory value.
- Overall model may have reduced dimensionality.

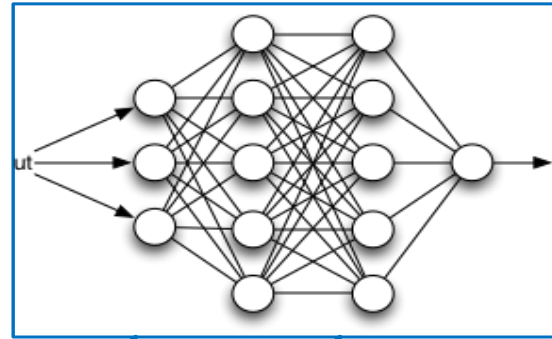

- Physical scientists and phenomena models from their disciplines can apply here.
- The hard sciences physical laws, and how they can be used to explain the externally visible behavior of the system of interest.

- Data scientists and their math/IT tools can apply here (data mining, pattern extraction, cognitive AI tooling).
- Tools and methods for discovery / extraction of recurring patterns of external behavior.

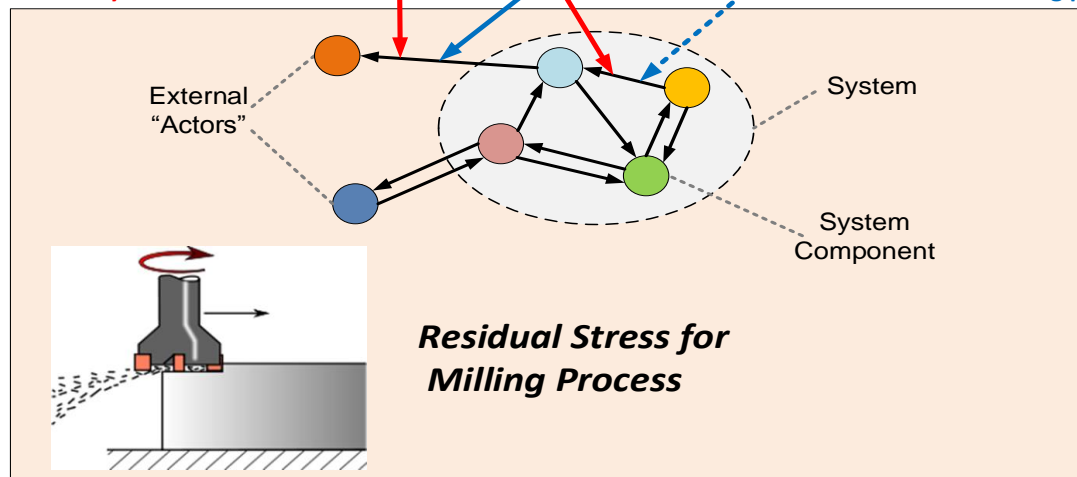

Real System Being Modeled

Hybrid Model: Both Data Driven and Physics-Based

- Predicts the external behavior of the System of Interest, visible externally to the external actors with which it interacts.
- Models (some aspects of) internal physical interactions of the System of Interest, and how they combine to cause/explain (some aspects of) externally visible behavior.
- Model has both external predictive value and (some) phenomena-based internal-to-external explanatory value.
- (Some) model intermediate quantities may not correspond to internal or external physical parameters, but combine to adequately predict external behavior, fitting it to compressed relationships.
- Model has external predictive value, but (for some aspects) not internal explanatory value.

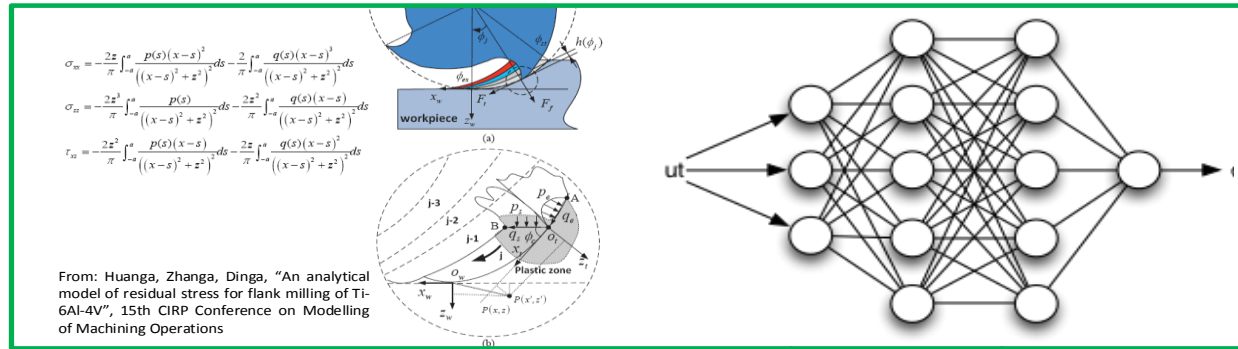

- Physical scientists and phenomena models from their disciplines can apply here.
- The hard sciences physical laws, and how they can be used to explain the externally visible behavior of the system of interest.

- Data scientists and their math/IT tools can apply here (data mining, pattern extraction, cognitive AI tooling).
- Tools and methods for discovery / extraction of recurring patterns of external behavior.

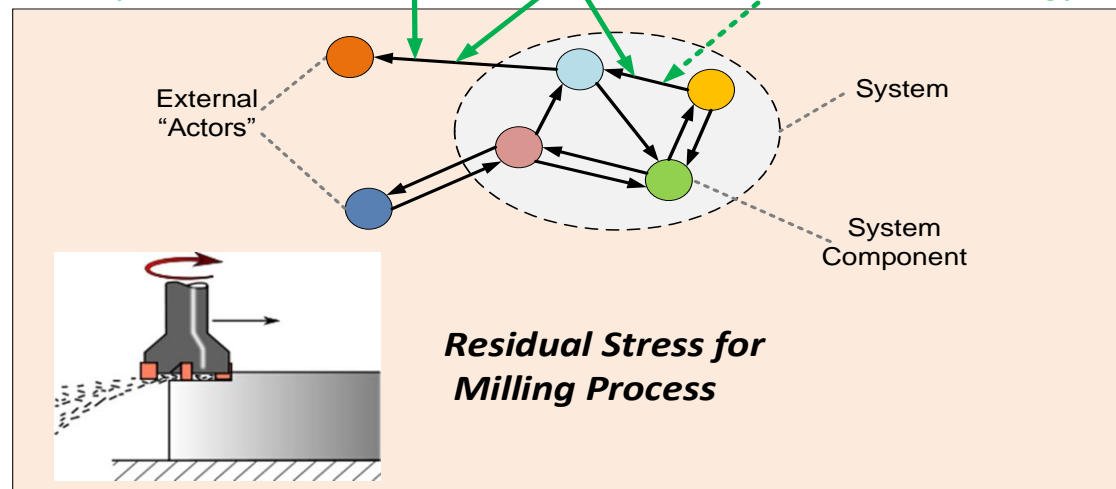

Real System Being Modeled

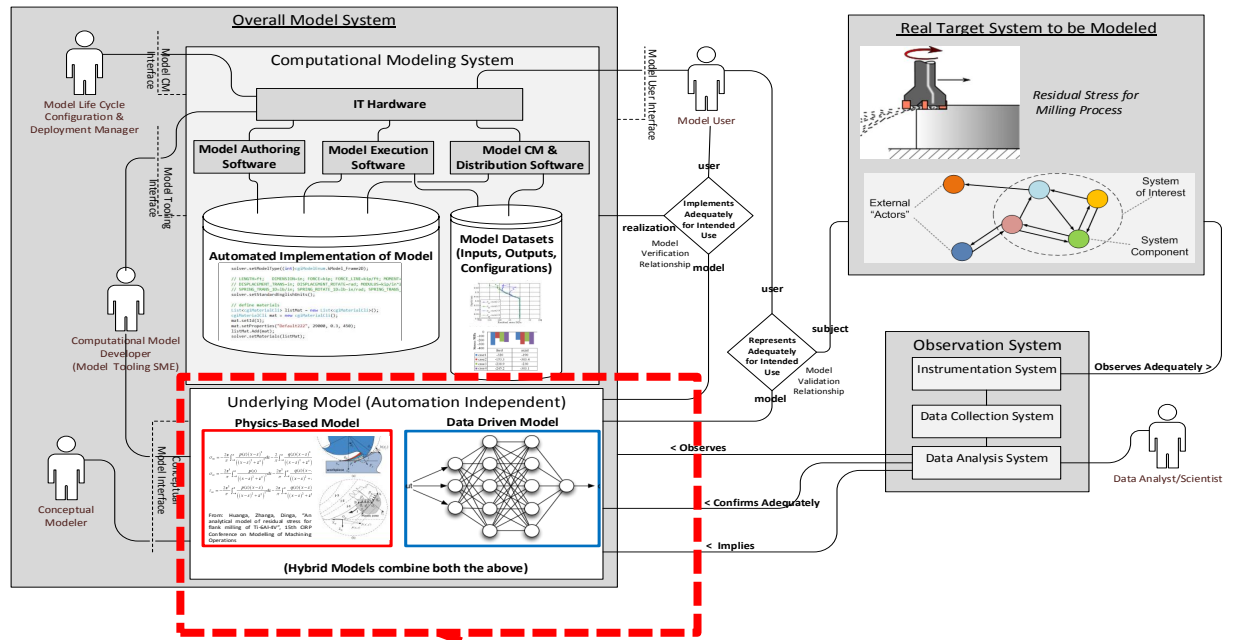

S*Pattern Hierarchy for Pattern-Based Systems Engineering (PBSE)

S*Metamodel for Model-Based Systems Engineering (MBSE)

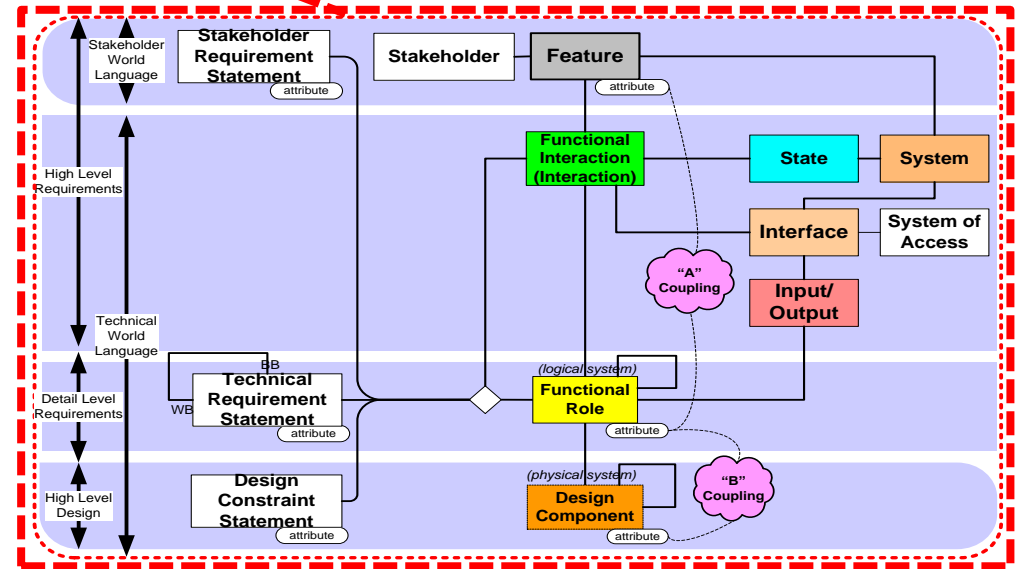
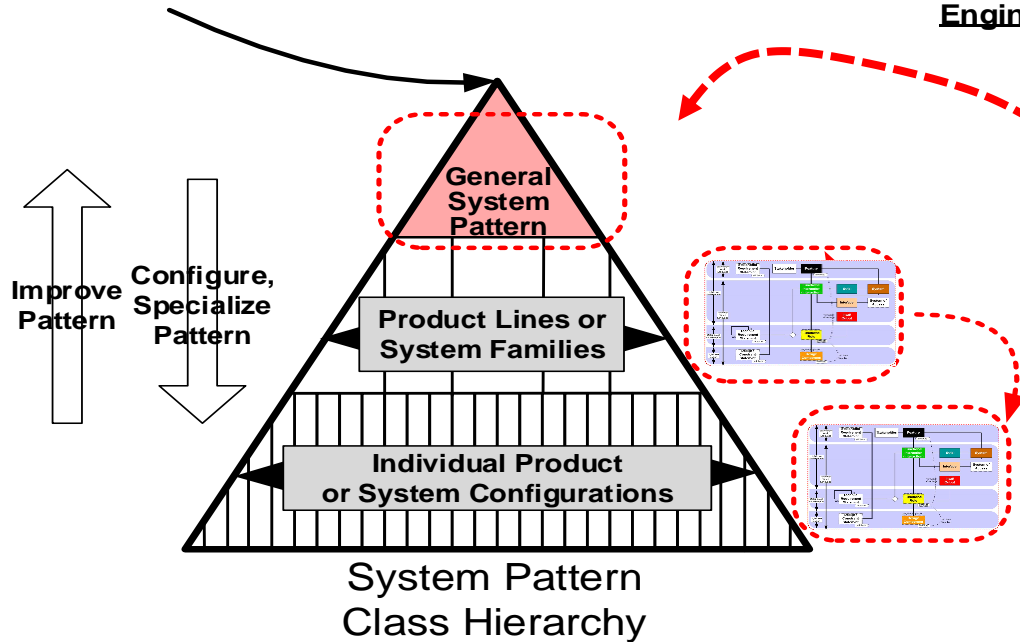



With SoS WG: Joint Activity Materials

- Support of SoS Pattern Library, including build-out of S*Metaclasses

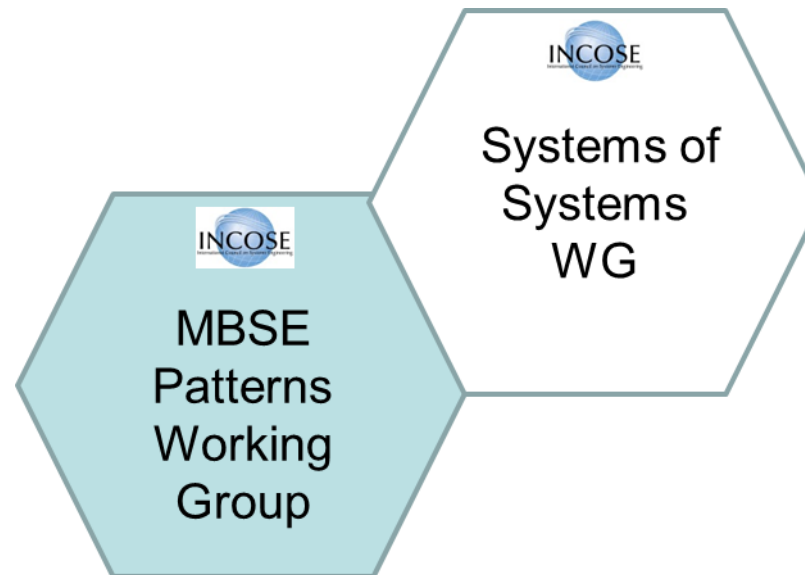

Primary Contact:
*John Fitzgerald,
Newcastle U.*

From the IW2016 Patterns in SoS Workshop



A Joint Workshop by:

- INCOSE Patterns Working Group
- INCOSE Systems of Systems Working Group



Patterns in Systems of Systems

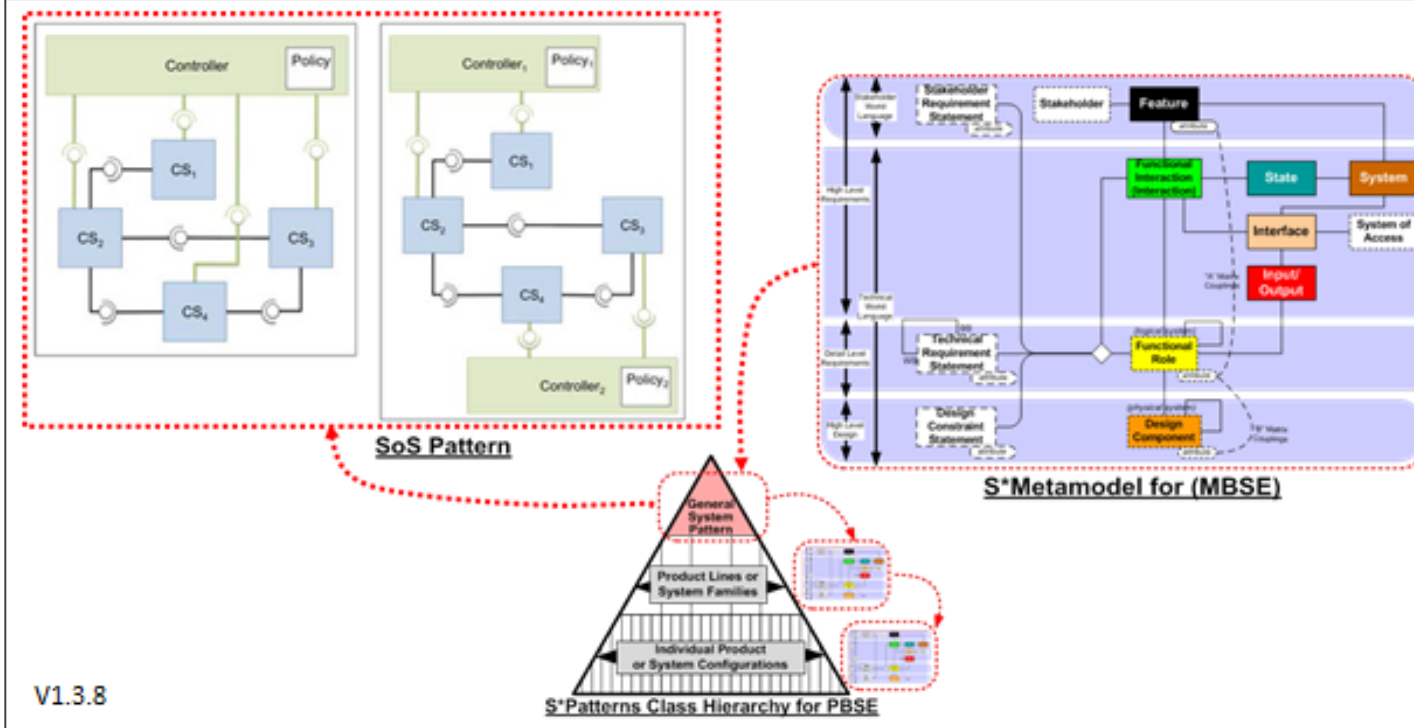



With Health Care WG: Joint Activity Materials

- Supporting the INCOSE Agile Health Care Systems Conference (third year) & the Health Care version of ASELCM Pattern

Primary Contact:
Chris Unger,
GE Health Care

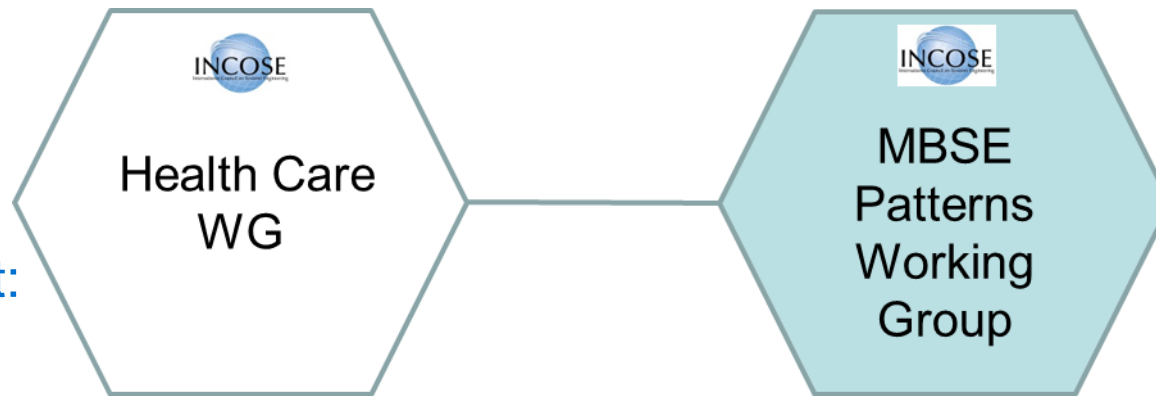

Agile Health Care Systems Conference



- Second conference held May, 2016, Chicago:
 - Presentations and attendance by medical systems enterprises
 - Also included sessions by Rick Dove and Bill Schindel
- Support on behalf of Agile and Patterns WG (Schindel):
 - Service on Conference Planning Committee, 2016 and 2017 conferences
 - Recruited keynote speaker: Operation Iraqi Freedom Command Surgeon, country-wide medical commander, Dr. Donald Dagliano—agile theater medicine keynote (additional help from Kevin Gunn)
 - Administration of conference web sites for PR, registration, submissions
- Now supporting third conference planning (May, 2017, Chicago)
- Primary conference organizer: INCOSE Health Care WG
 - Planning Committee also supported by Crossroads of America Chapter

2016 Agile Health Care Systems Conference



- One session and break out group addressed the application of the ASELCM Pattern to assessing agility opportunities in the Health Care Domain:

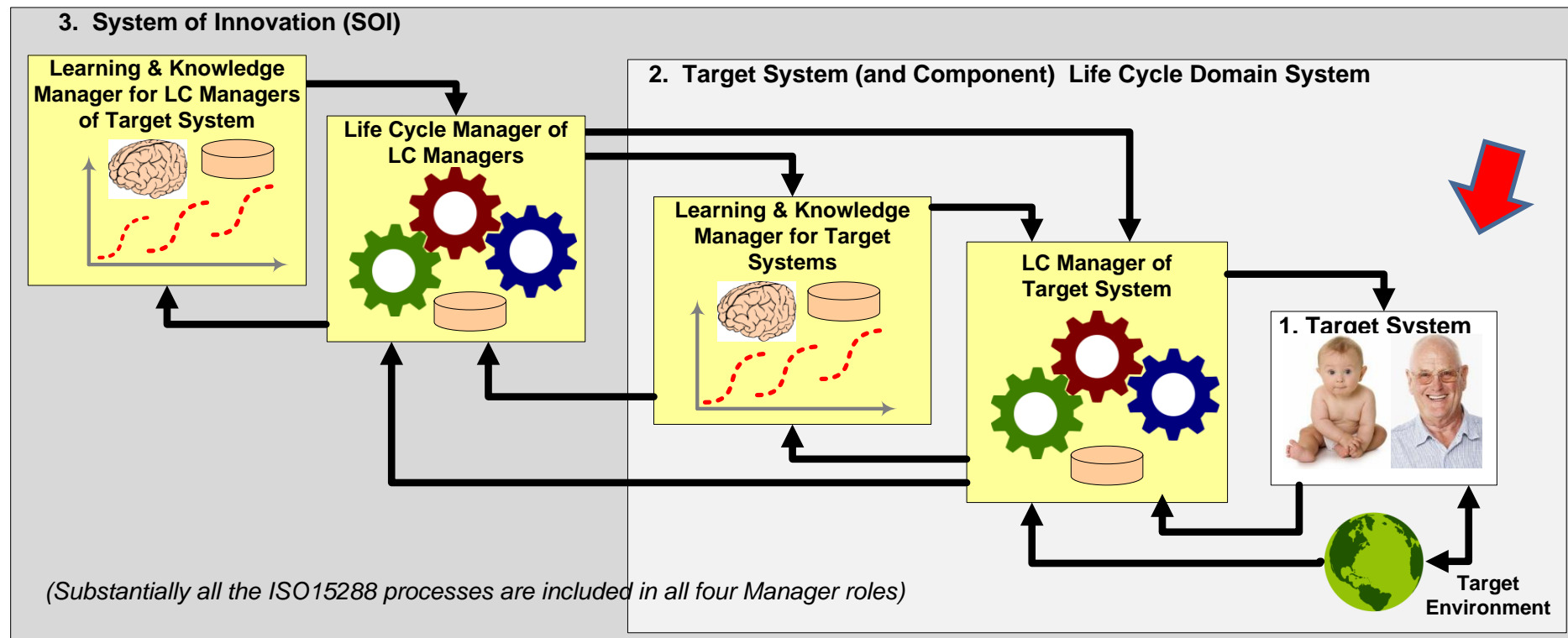

Results of that 2016 break out group use of ASELCM Pattern:

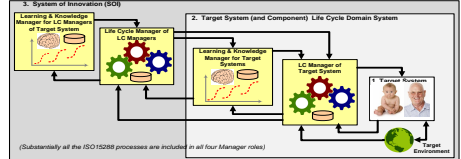

- Sticky Dots**
- Needs for improved future agility (even if most difficult)
 - Opportunities for improved future agility (low-hanging fruit)
 - Already accomplished examples of improved agility progress (e.g., defense theater medicine, device software, etc.)

3. Health Care System of Innovation (SOI)

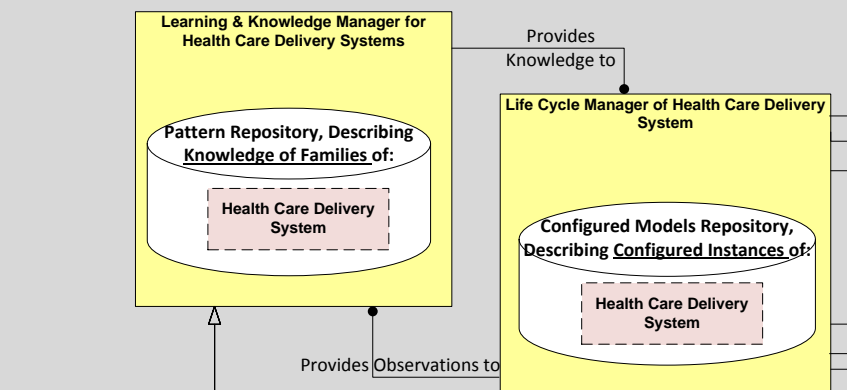

2. Patient Health Life Cycle Domain System

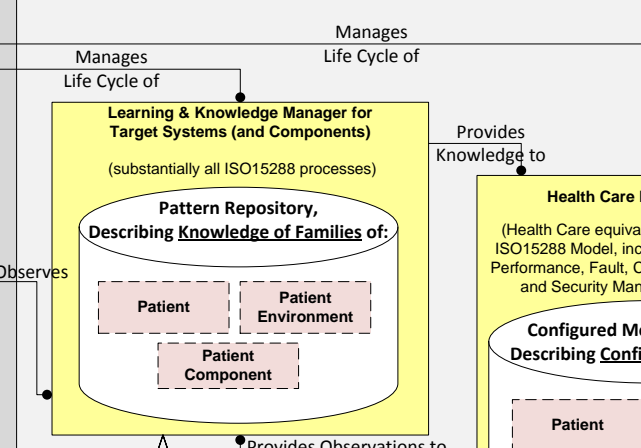

Sticky note In the domain model, identify potential corrections or improvements to the model

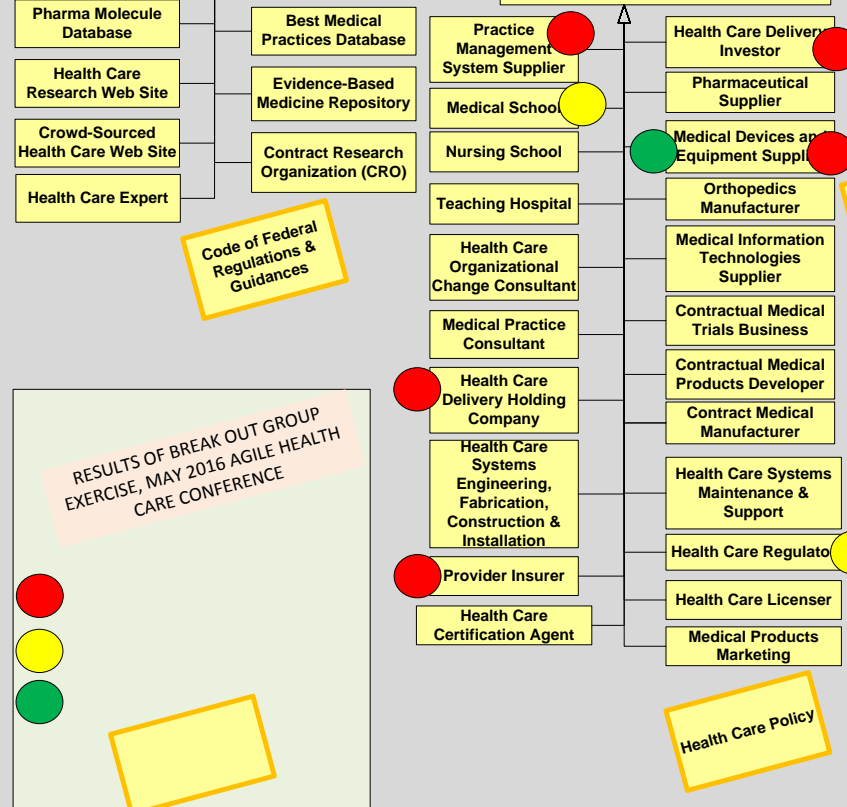

RESULTS OF BREAK OUT GROUP EXERCISE, MAY 2016 AGILE HEALTH CARE CONFERENCE

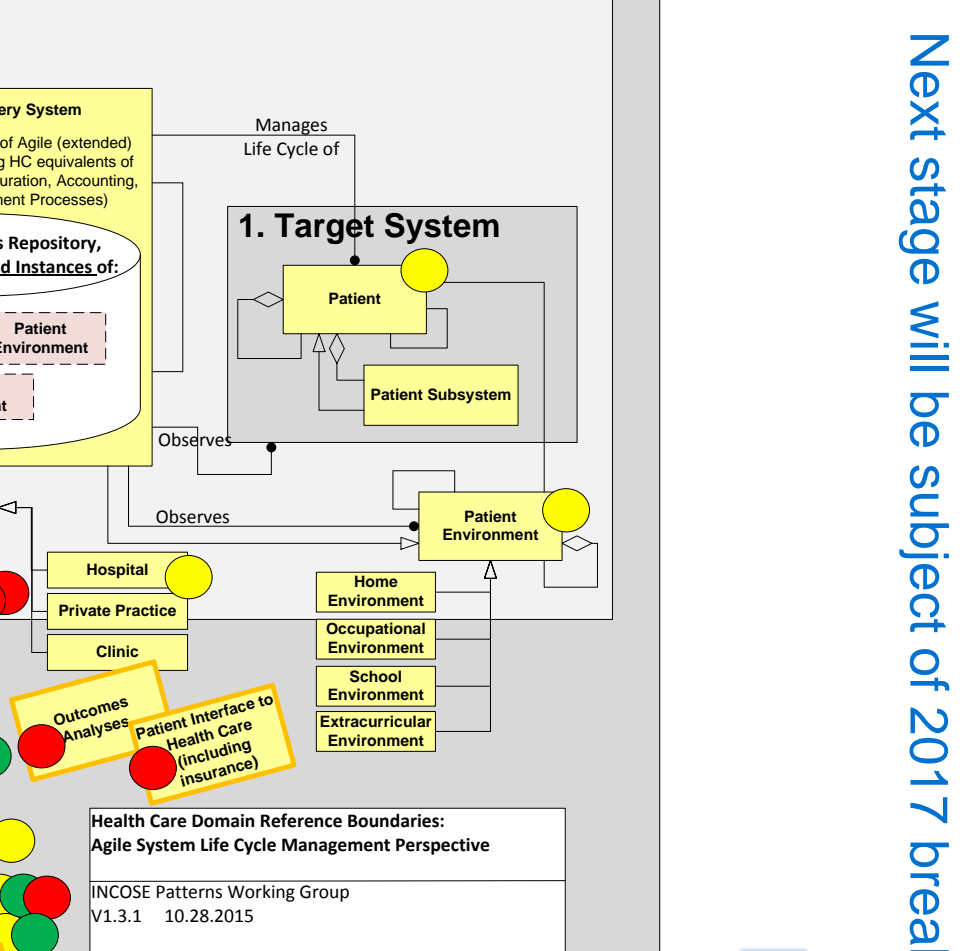
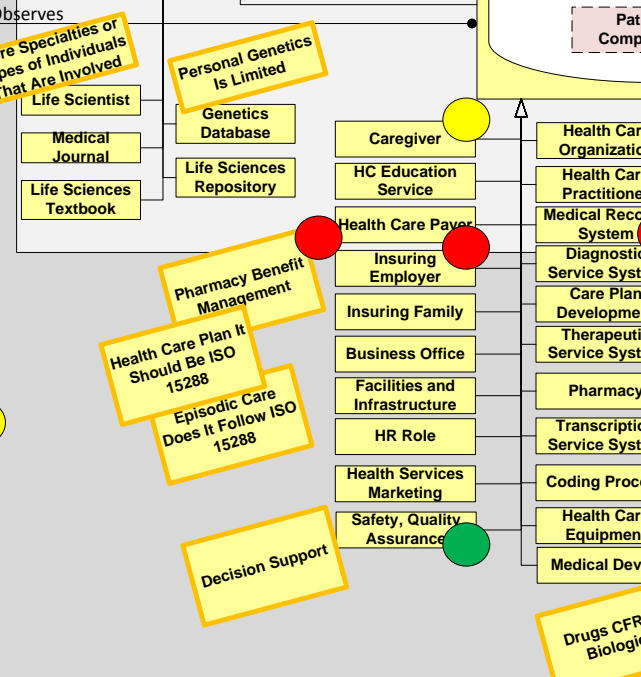

Health Care Domain Reference Boundaries: Agile System Life Cycle Management Perspective
INCOSE Patterns Working Group
V1.3.1 10.28.2015

Next stage will be subject of 2017 break out

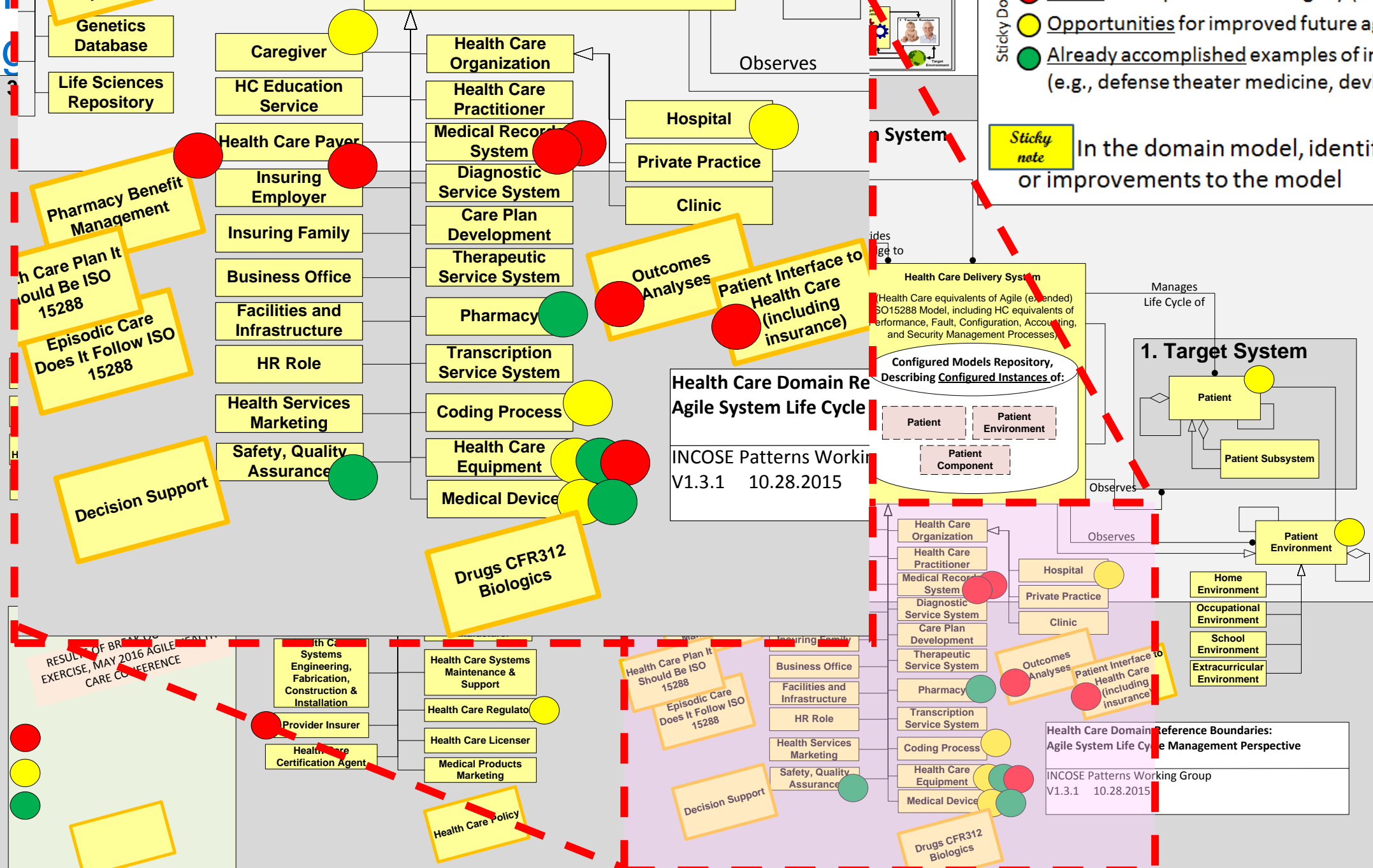

Sticky Dots

- Needs for improved future agility (even if most difficult)
- Opportunities for improved future agility (low-hanging fruit)
- Already accomplished examples of improved agility progress (e.g., defense theater medicine, device software, etc.)

Sticky note In the domain model, identify potential corrections or improvements to the model

Next stage will be subject of 2017 breakout

RESULTS OF BREAKOUT EXERCISE, MAY 2016 AGILE HEALTH CARE CONFERENCE

Health Care Domain Reference Boundaries: Agile System Life Cycle Management Perspective
 INCOSE Patterns Working Group
 V1.3.1 10.28.2015

With Critical Infrastructure Protection, and Recovery WG: Joint Activity Materials



- S*Patterns for Critical Infrastructure, Electrical Power, Common Recovery Model: including ASELCM Systems 1, 2, 3

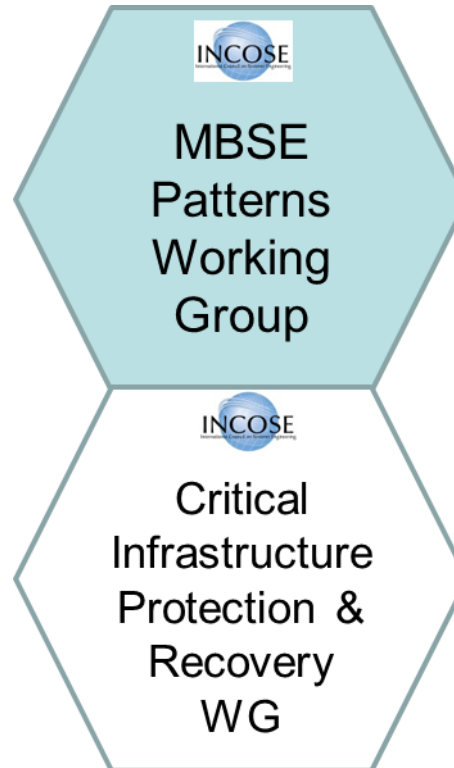

Primary Contact:
Mike DeLamar, Bechtel
Mark Walker, BCT



IEEE / INCOSE / NASA Energy Tech 2016 Conference

- Held November, 2016, Cleveland
- Electrical Power Grid + Critical Infrastructure Protection, Recovery
- Utilized ASELCM Pattern as framework to develop initial domain pattern content for this conference and its discussion
- Model-Based Facilitation used to solicit, capture, and understand conference sessions and group discussion, in system context.
- Conference proceedings being generated by organizers, supported by explanatory S*Patterns.
- Follow on plans include continued ASELCM MBSE Pattern support for Common Recover Model (CRM) research by Purdue U doctoral student, power industry expert.
- Discussion of similar activity being held by Patterns WG with CIPR WG at IW 2017.



ASELCM Pattern Logical Architecture

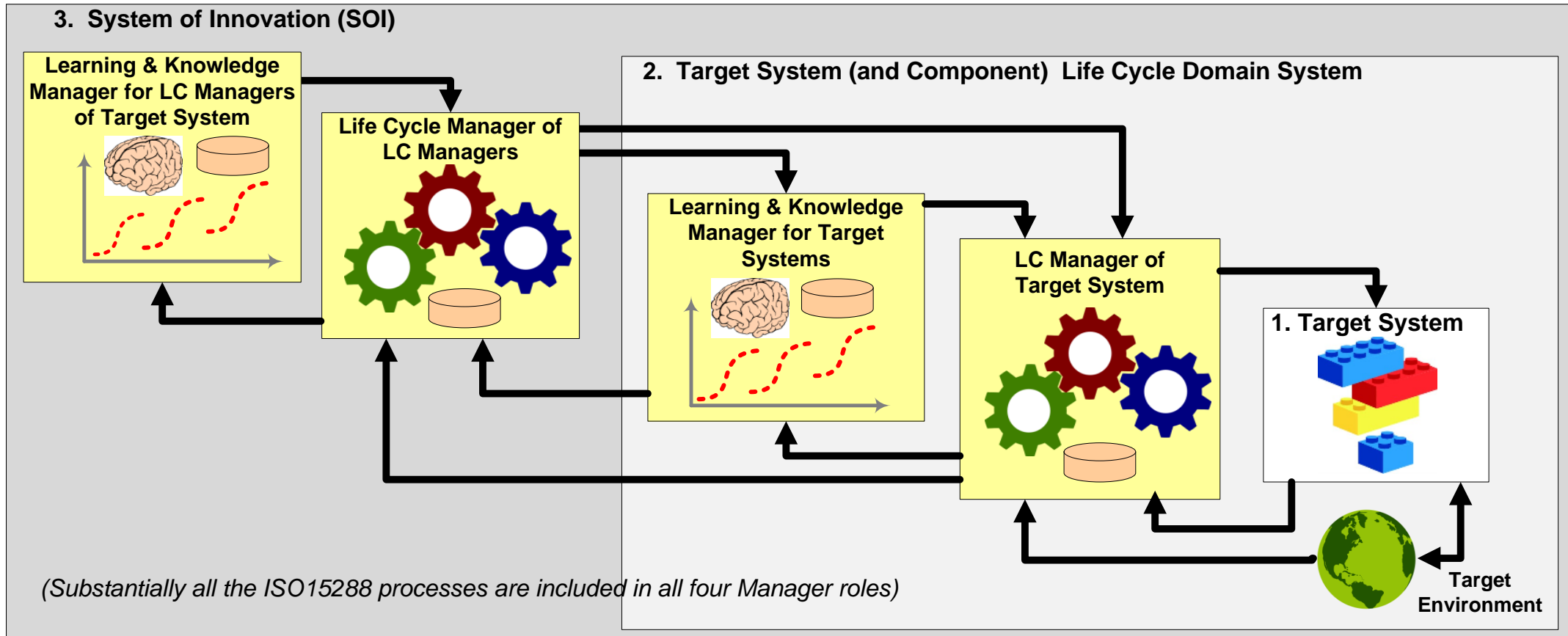

- System 1: Target system of interest, to be engineered or improved.
- System 2: The environment of (interacting with) S1, including all the life cycle management systems of S1, including learning about S1.
- System 3: The life cycle management systems for S2, including learning about S2.

System 3: Electrical Power System of Innovation (SOI)

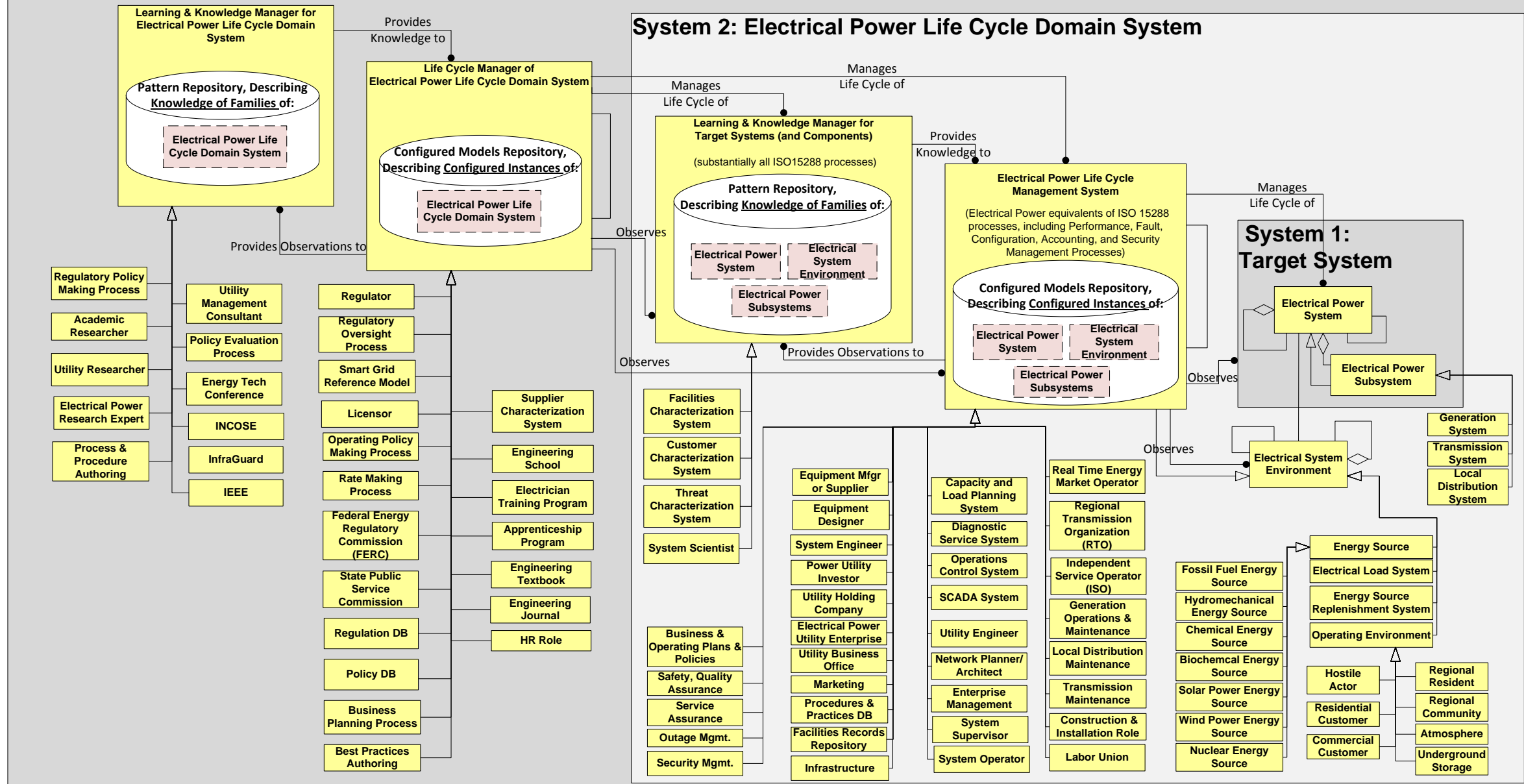

System 2, 3 framework for Electrical Power Grid

Use of ASELCM Pattern to capture Track 1 participants' discussion at Energy Tech 2016 Conference:



System 3: Electrical Power System of Innovation (SOI)

Show as SoS

System 2: Electrical Power Life Cycle Domain System

Show as SoS

System 1: Target System

Show as SoS

- What improved agility or MBSE use "results"?
 - In the domain models, marked the highest cases of:
 - Needs for improved future results (even if most difficult)
 - Opportunities for improved future results (low-hanging fruit)
 - Already accomplished examples of improved results progress (e.g., requirements engineering, simulation, etc.)
- Sticky note: In the domain model, identify potential corrections or improvements to the model / framework.

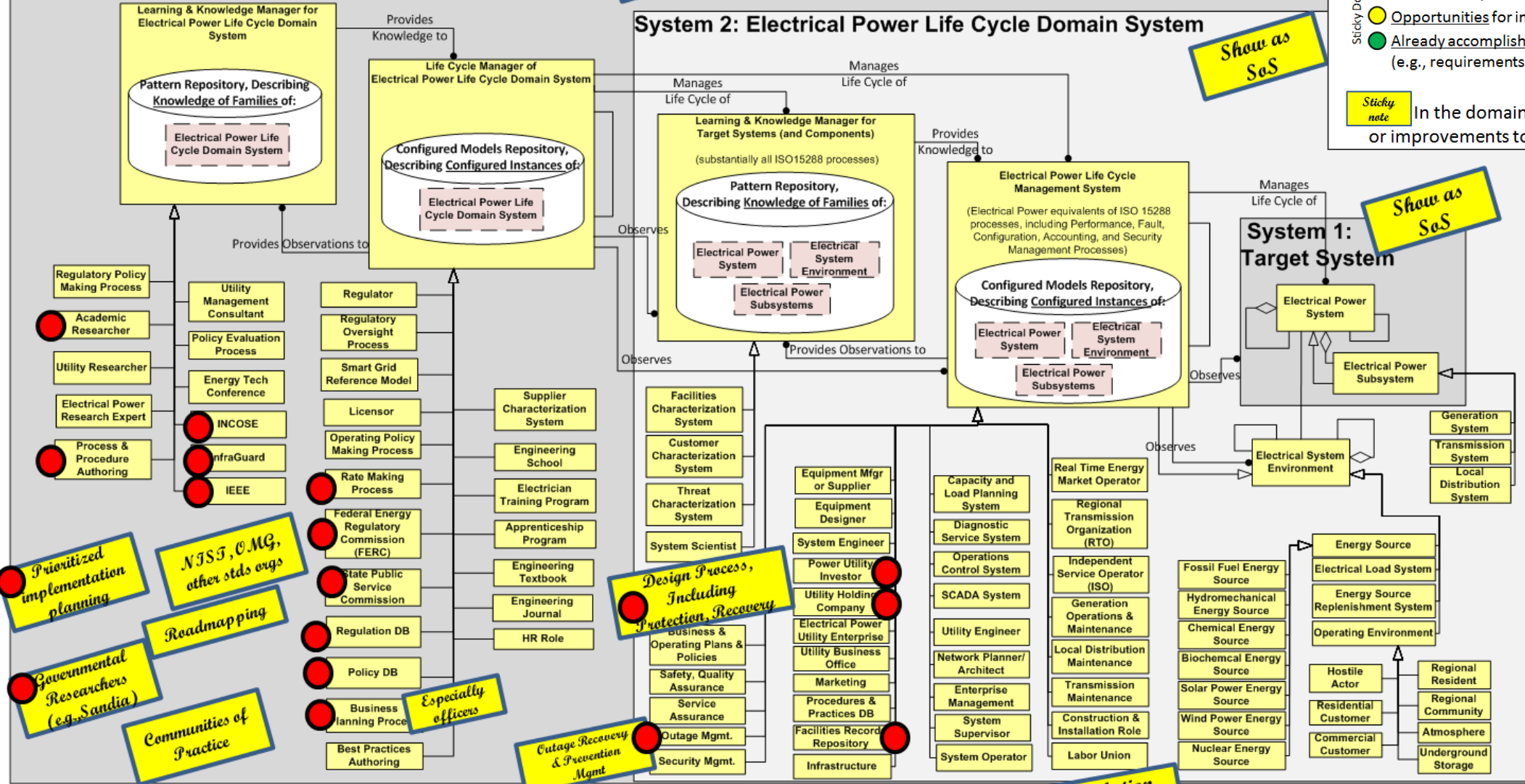

Prioritized implementation planning
 Governmental Researchers (e.g., Sandia)
 Roadmapping
 Communities of Practice

Design Process, Including Protection, Recovery

Outage Recovery & Prevention Mgmt

Resilience Model

Group related roles

Simulation Tools

Insurers

Especially officers

INCOSE Agile System Life Cycle Management Perspective: System 1, 2, 3 Framework for Electrical Power Domain
 INCOSE Patterns Working Group
 Bill Schindel
 V1.3.1 12.04.2016

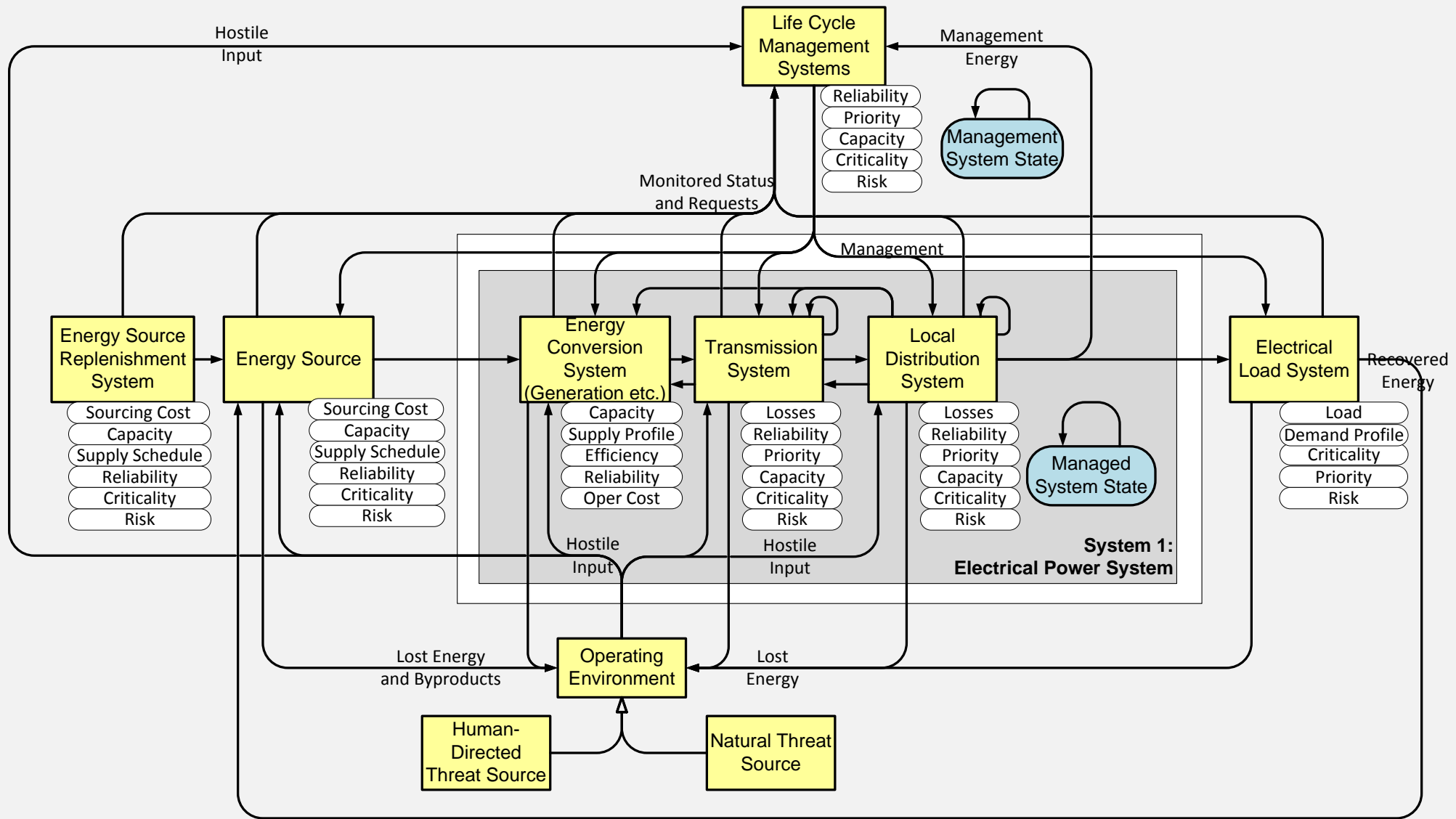

System 2: Electrical Power Life Cycle Domain System

System 1 framework for Electrical Power Grid

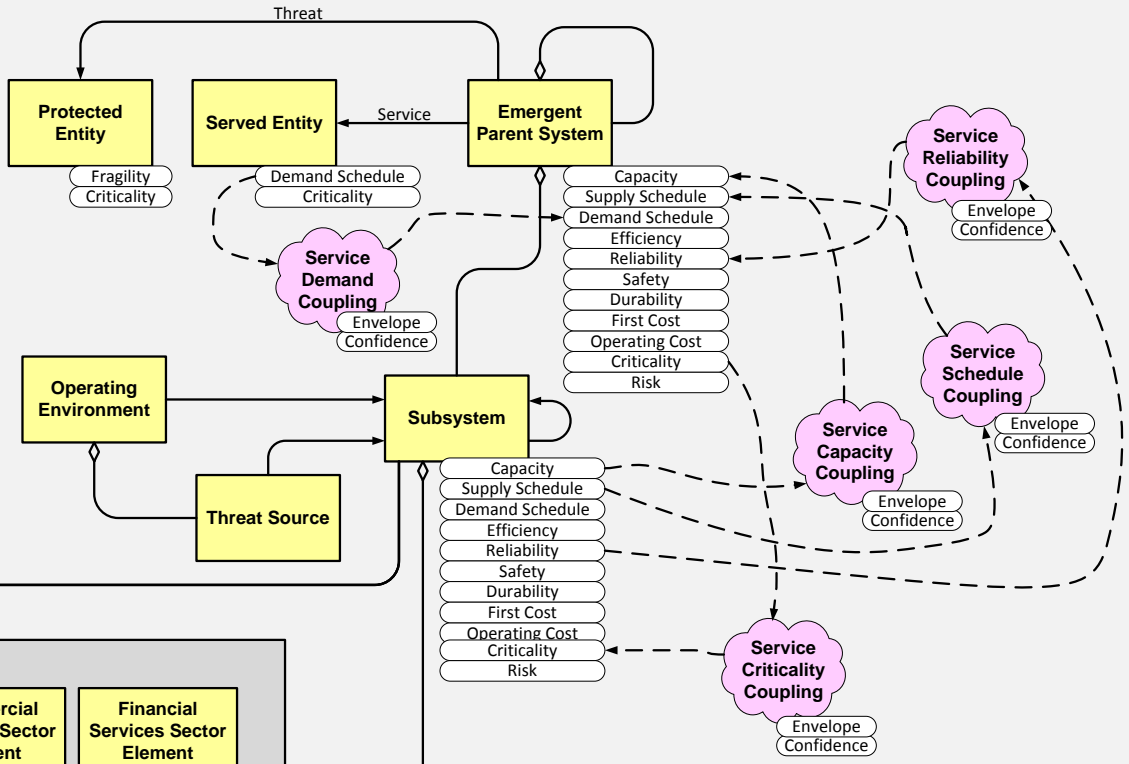
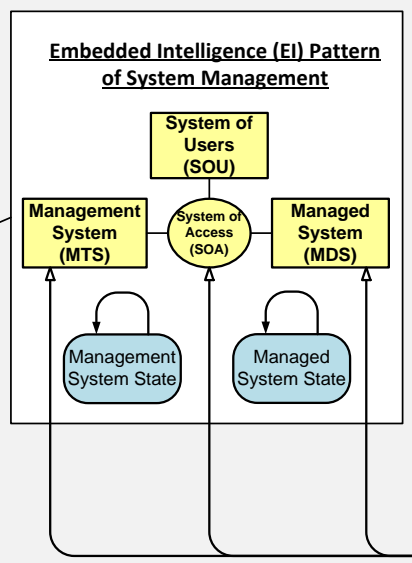
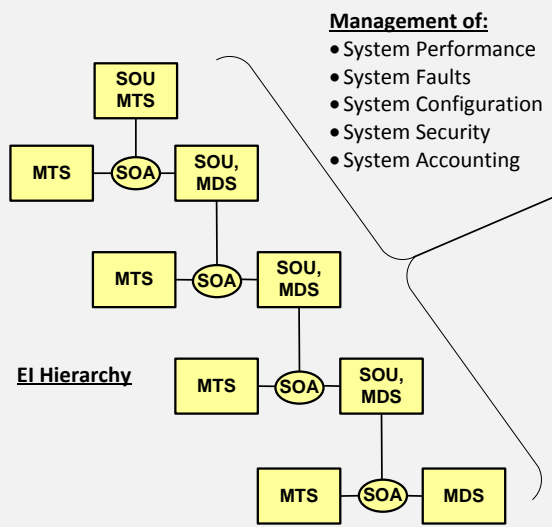

System 1: Critical Infrastructure System
(Per DHS and PPD-21)

Information Technology Sector Element	Chemical Sector Element	Commercial Facilities Sector Element	Financial Services Sector Element
Nuclear Reactors, Materials, Waste Sector Element	Critical Manufacturing Sector Element	Communications Sector Element	Food and Agricultural Sector Element
Transportation Systems Sector Element	Dams Sector Element	Defense Industrial Base Sector Element	Government Facilities Sector Element
Water and Wastewater Systems Sector Element	Emergency Services Sector Element	Energy Sector Element	Healthcare and Public Health Sector Element

System 2: Application Life Cycle Domain System

System 1 framework for Critical Infrastructure, per US DHS CIPR categories

System of Innovation (SOI) Pattern Logical Architecture

(Adapted from ISO/IEC 15288:2015)

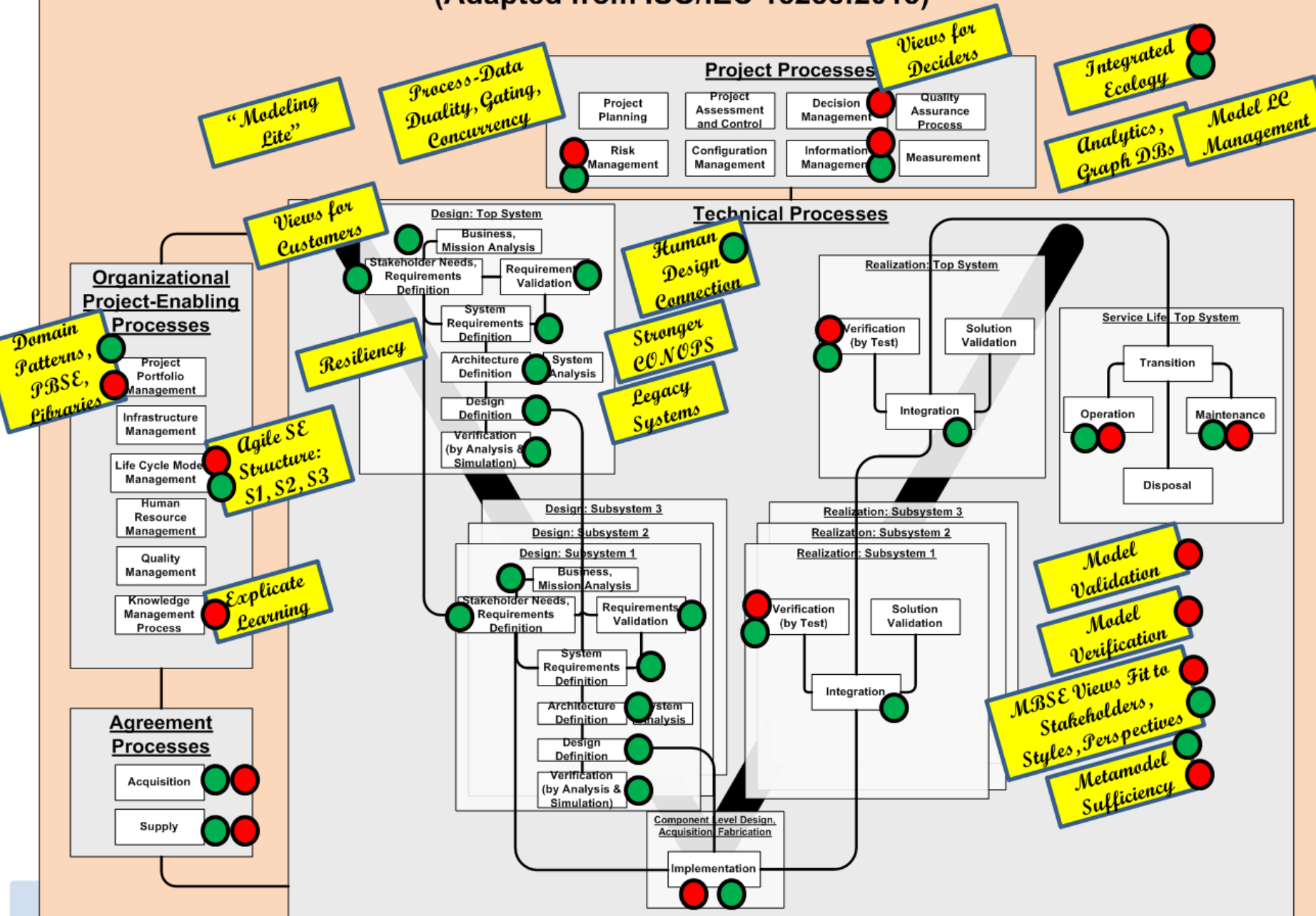

- What improved agility or MBSE use “results”?
- In the domain models, marked the highest cases of:
 - Needs for improved future results (even if most difficult)
 - Opportunities for improved future results (low-hanging fruit)
 - Already accomplished examples of improved results progress (e.g., requirements engineering, simulation, etc.)
- Sticky note** In the domain model, identify potential corrections or improvements to the model / framework.

Use of ASELCM Pattern to capture Track 1 participants’ discussion at Energy Tech 2016 Conference (MBSE Focus)

With Systems Science WG: Joint Activity Materials



- S*Interactions & S*Patterns as a basis for a hard science of systems

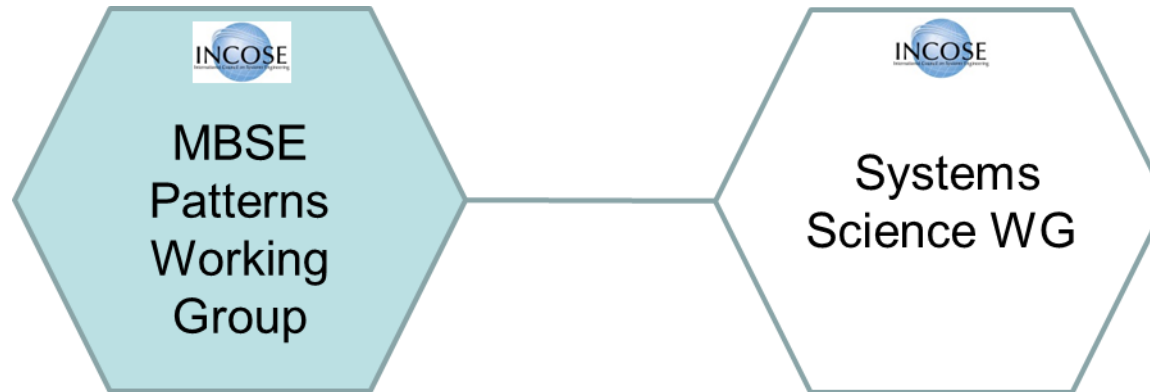

Primary Contact:
*David Rousseau, Centre
for Systems Philosophy*



Questions posed by SSWG: Patterns WG to present against these in Jan 30 SSWG Workshop

1. What are [S*Patterns & S*PBSE]? Basic description or definition.
2. Why are we interested in [S*Patterns & S*PBSE]? Why are they important? What could/do they reveal about systems?
3. How can/do we use [S*Patterns & S*PBSE] in the context of SE? What SE practices could leverage knowledge about [S*Patterns & S*PBSE]? How would SE be different/stronger if we had some/more/better [S*Patterns & S*PBSE]?
4. How can we discover/develop/improve [S*Patterns & S*PBSE]?
5. What do you see as the most important next step for SysSci/SE to make advances in [S*Patterns & S*PBSE]?

Quick summary of answers, details follow in Pres1 (IS 2016) and Pres2 (ISSS 2016) and Doc3 (INCOSE 2015)



1. What are [S*Patterns & S*PBSE]? Basic description or definition.
 - *Answered in Doc 3. S*Models are MBSE models conforming to the S*Metamodel. S*Patterns are configurable, reusable general S*Models of families of systems. A configured S*Pattern is itself an S*Model of a more specific system.*
2. Why are we interested in [S*Patterns & S*PBSE]? Why are they important? What could/do they reveal about systems?
 - *When “we” are engineers, the answer is that they provide a more effective way (PBSE) to perform (MB) systems engineering (e.g., ISO 15288), leveraged by revealed S*Patterns. When we are engineers or scientists, S*Models provide predictive and explanatory representations of systems and system phenomena. See Pres1, 2.*
3. How can/do we use [S*Patterns & S*PBSE] in the context of SE? What SE practices could leverage knowledge about [S*Patterns & S*PBSE]? How would SE be different/stronger if we had some/more/better [S*Patterns & S*PBSE]?
 - *They are already used for many years to perform SE across many domains. “Leverage” is the very essence of PBSE, using S*Pattern assets. For MBSE practitioners not using PBSE, their work would be reduced, speed increased, and early stage quality/completeness improved. See Doc3.*
4. How can we discover/develop/improve [S*Patterns & S*PBSE]?
 - *The Uncover the Pattern (UTP) process is a good introduction to pattern discovery, a part of Pattern Management. The larger picture of ongoing pattern improvement is described by the INCOSE ASELCM Pattern. See Pres2.*
5. What do you see as the most important next step for SysSci/SE to make advances in [S*Patterns & S*PBSE]?
 - *First step for anyone interested is to practice their use personally—this is a contact/practice, not spectator, sport.*
 - *As to advances in patterns, the essence of the ASELCM Pattern is that improvement.*
 - *See Pres2.*



Pres1 (IS 2016)

Energy per unit volume before = Energy per unit volume after
 $P_1 + \frac{1}{2}\rho v_1^2 + \rho gh_1 = P_2 + \frac{1}{2}\rho v_2^2 + \rho gh_2$

Flow velocity $v_2 > v_1$
 $P_2 < P_1$

Forces in a Climb
 climb angle = α
 Lift L
 Drag D
 Weight W
 Thrust F

Equations:
 $L \cos(\alpha) + F \sin(\alpha) - D \sin(\alpha) - W \sin(\alpha) = m a$ (vertical)
 $F \cos(\alpha) - L \sin(\alpha) - D \cos(\alpha) = m a$ (horizontal)
 Definition of Excess Thrust: $F - D = F_{ex}$
 $L \cos(\alpha) = F_{ex} \sin(\alpha) = W \sin(\alpha)$
 $F_{ex} \cos(\alpha) = L \sin(\alpha)$

26th Annual INCOSE International Symposium
 Edinburgh, UK
 July 18 - 21, 2016

Got Phenomena? Science-Based Disciplines for Emerging Systems Challenges

Bill Schindel, ICTT System Sciences
schindel@icct.com

Copyright © 2016 by William D. Schindel
Published and used by INCOSE with permission

V1.4.2

26th Annual INCOSE International Symposium (IS 2016)
 Edinburgh, Scotland, UK, July 18-21, 2016

Got Phenomena? Science-Based Disciplines for Emerging Systems Challenges

Bill Schindel
 ICTT System Sciences
www.icct.com

Abstract: Engineering disciplines (ME, EE, CS, etc.) originate from their fields' own "natural phenomena." The "science" based laws, and their principles, concepts, theories, and phenomena, have emerged from phenomenological observations. We argue that the "science" based phenomena-based knowledge is the foundation for the emergence of engineering disciplines and challenges. We argue that the "science" based phenomena-based knowledge is the foundation for the emergence of engineering disciplines and challenges. We argue that the "science" based phenomena-based knowledge is the foundation for the emergence of engineering disciplines and challenges.

1. Introduction
 We argue that laws and phenomena of natural phenomena are the foundation for the emergence of engineering disciplines and challenges. We argue that the "science" based phenomena-based knowledge is the foundation for the emergence of engineering disciplines and challenges.

Figure 1: En garde! Not what you may be expecting

Pres2 (ISSS 2016)



Where Do Systems Come From, and Where Do They Go?

*Patterns in Model-Based Systems Engineering:
Emergence of Purpose, Fitness, Value, Resilience



ISSS2016 Plenary VIII Panel:
Prospects for Scientific Systemic Synthesis

1.2.4



Bill Schindel
schindel@icct.com



Doc 3 (2015)

1 Title: Pattern-Based Systems Engineering (PBSE), Based On S*MBSE Models 2 Overview 2.1 Executive Summary

This document summarizes Pattern-Based Systems Engineering (PBSE) Methodology, a form of MBSE based on use of the S*Metamodel. In this approach, re-usable, configurable S*Models (which are MBSE models conforming to the S*Metamodel) are created, then used and re-used across a range of different system configurations or family members, and improved over time as the point of distillation of learning. These re-usable, configurable S*Models are called S*Patterns to emphasize their recurring use, and are model-based substantial extensions of earlier, pre-MBSE engineering patterns.

As shown in Figure 1, methodologies for systems engineering are concerned with both (1) the engineering process and (2) the information that is consumed and produced by that process. In comparison to a strong historical systems engineering emphasis on process, this methodology increases the relative emphasis on the information passing through that process, with favorable impacts on process outcomes. That information is in the form of explicit MBSE system models of stakeholder value, requirements, design, risk, and other aspects, comparable in many aspects to other MBSE methodologies (Estefan 2008), but also strengthened (by the S*Metamodel) in certain areas, and compatible with contemporary modeling languages and tools. The emphasis on that information is on description of the engineered system, not the system of engineering.

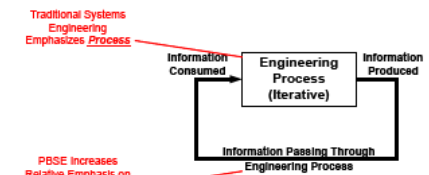

Figure 1: The Engineering Process Consumes and Produces Information, Iteratively
PBSE builds on historical work in patterns, through introduction of MBSE models (many historical engineering patterns were not explicit MBSE models), expansion of pattern scope to whole system families, platforms, and domains (as opposed to smaller-scale localized patterns), and foundation on a stronger MBSE metamodel to express systemic phenomena critical to engineering applications with clearer connection to scientific understanding of systems phenomena.

PBSE Extension of MBSE—Methodology Summary V1.5.AA

1

Additional references:

Many additional references on Patterns WG web site: <http://www.omgwiki.org/MBSE/doku.php?id=mbse:patterns:patterns>

With Tools Interoperability & Model Life Cycle Management WG: Joint Activity



- Patterns of collaboration in future innovation ecosystems, including illustrative content

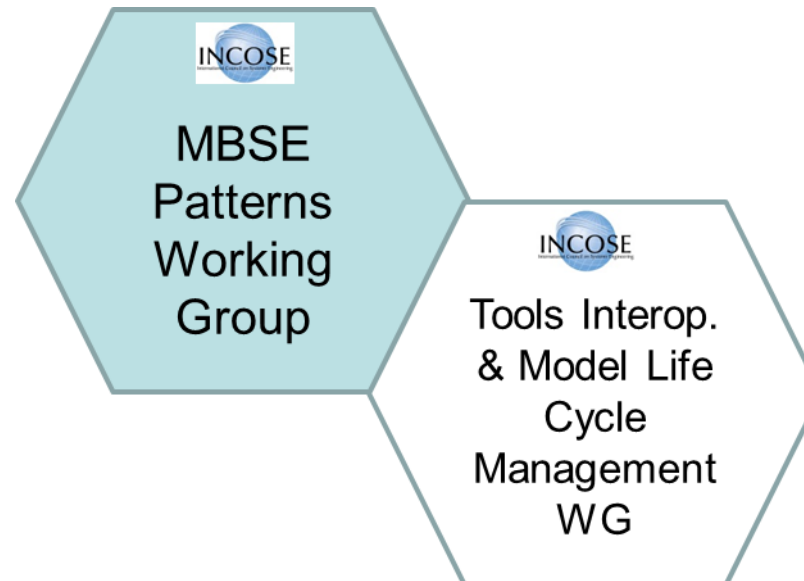

Primary Contact:
Lonnie VanZandt,
Sodius

With Tools Interoperability & Model Life Cycle Management WG: Joint Activity



INCOSE MBSE Patterns Working Group

Contributions to Reference Ecosystem
for Collaborative Innovation

For Product Line Life Cycle
Patterns & Configurations

INCOSE
International Council on Systems Engineering

MBSE Patterns Working Group

V1.2.9

- More WG and other partners to be added.



Patterns WG Planning and Support

- Roles as an INCOSE/OMG MBSE Challenge Team:
 - Support for MBSE Initiative, and for its lead team
 - Support for MBSE Transformation, and for its lead team
- Roles as an INCOSE WG:
 - New Patterns WG web site, in INCOSE main web:
<http://www.incose.org/ChaptersGroups/WorkingGroups/Transformational/mbse-patterns>
 - Existing (main) Patterns WG web site maintained within INCOSE-OMG joint MBSE Initiative “MBSE wiki”:
<http://www.omgwiki.org/MBSE/doku.php?id=mbse:patterns:patterns>



Patterns WG Planning and Support

- Future potential PWG Projects:

- Depends on your interest to work on them
- Existing projects with partners
- Others that our members have mentioned in the past:

- Support for deliverables of the INCOSE MBSE Transformation Lead Team
- Additional targeted system application domain patterns
- Targeted science domain patterns
- ISO 15288 Implications of PBSE
- PBSE support for COTS Tools and Information Systems
- Visualization
- PBSE Implementation strategies & roadmaps, scenarios
- PBSE contribution to SEBoK

- Interest in these or other projects

- Open Discussion

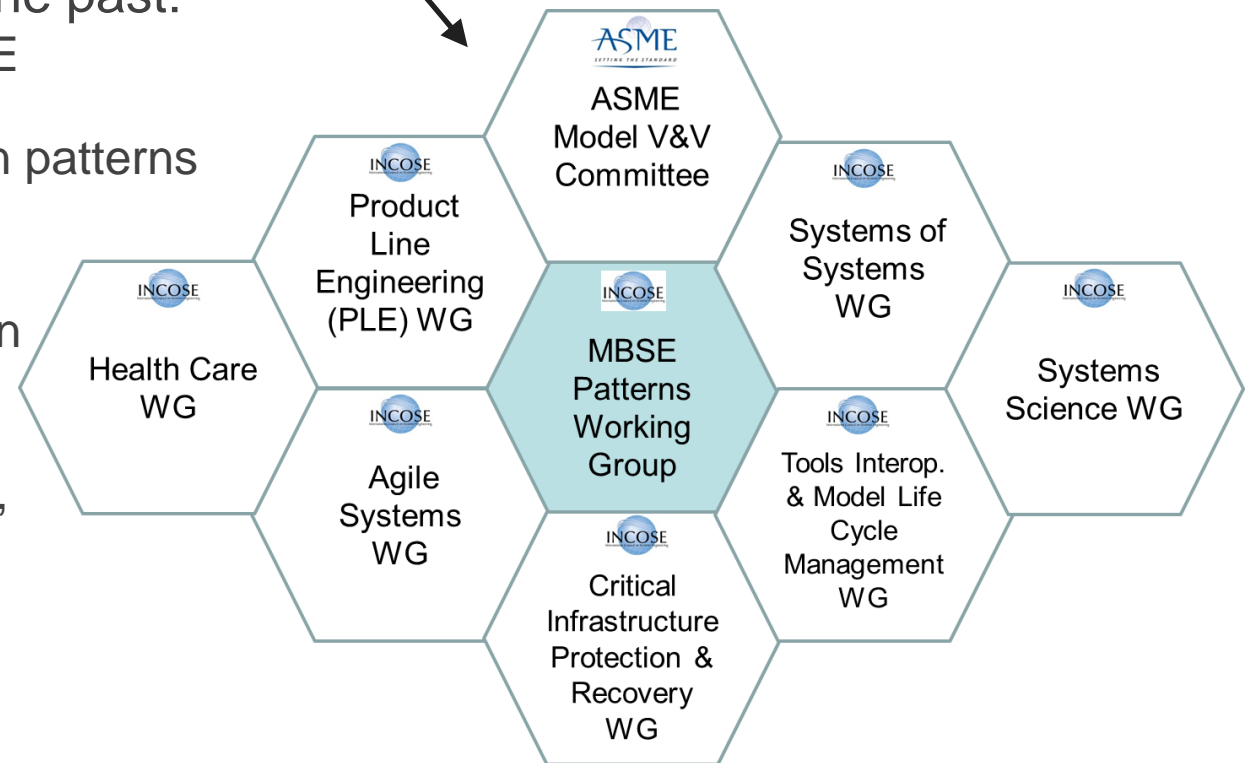



Example S*Pattern Content

- INCOSE PBSE Tutorial:
 - http://www.omgwiki.org/MBSE/lib/exe/fetch.php?media=mbse:patterns:pbse_tutorial_glrc_2013_v1.6.3_reduced_pdf.pdf
- More examples and materials on WG web wiki site:
 - <http://www.omgwiki.org/MBSE/doku.php?id=mbse:patterns:patterns>



27th annual **INCOSE**
international symposium

Adelaide, Australia
July 15 - 20, 2017

