

William Rowan Hamilton



2018
Annual **INCOSE**
international workshop
Jacksonville, FL, USA
January 20 - 23, 2018



Emmy Noether

System Patterns: The System Phenomenon, Hamilton's Principle, and Noether's Theorem as a Basis for System Science

IW2018 System Science Working Group Meeting, 01.23.2018

Bill Schindel

ICTT System Sciences

schindel@icct.com

V1.2.1 Copyright © 2018 by William D. Schindel
Published and used by INCOSE with permission

Abstract



Each of the traditional engineering disciplines (EE, CE, ME, ChE, etc.) are concerned with certain physical phenomena, and founded on related explanatory theories and math-physics models of those phenomena, strengthening ability to perform the engineering practices of the discipline. However, it is sometimes suggested that Systems Engineering so far lacks, and is still seeking, some equivalent underlying theory that is grounded in base phenomena and described by explanatory model content, on an impactful par with those of the other engineering disciplines. Here we argue that (1) that there is such an underlying System Phenomenon, (2) that its explanatory, model-based theory already exists in the form of Hamilton's Principle, (3) that this phenomena and theory are the more general parent cases of the more familiar phenomena and model-based theories of each of the traditional engineering disciplines, and (4) that for the emerging larger-scale systems of practical interest to systems engineering and society, new larger-scale phenomena, explanatory model-based theories, and engineering disciplines may be derived from this same general parent.

A traditional view

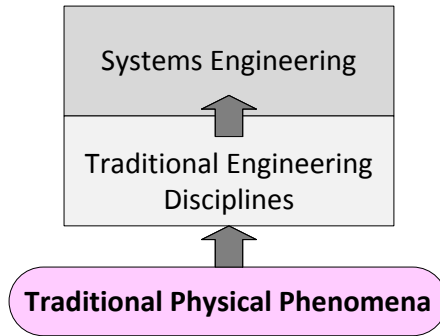

Contents

Our view

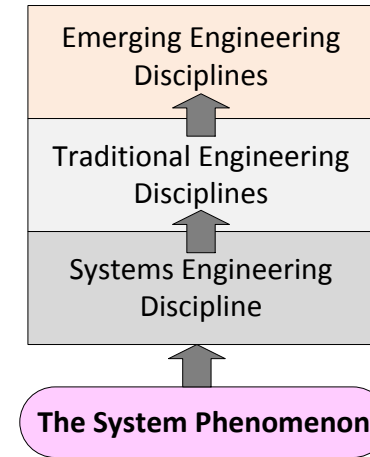

- Phenomena-based Engineering Disciplines
- The Traditional Perspective
- MBSE, PBSE: A Phase Change in Systems Engineering
- The System Phenomenon
- Hamilton's Principle and Noether's Theorem
- The New Perspective
- More Recent Examples
- Future Applications
- Where Do Systems Come From, and Where Do They Go?
- What You Can Do
- References

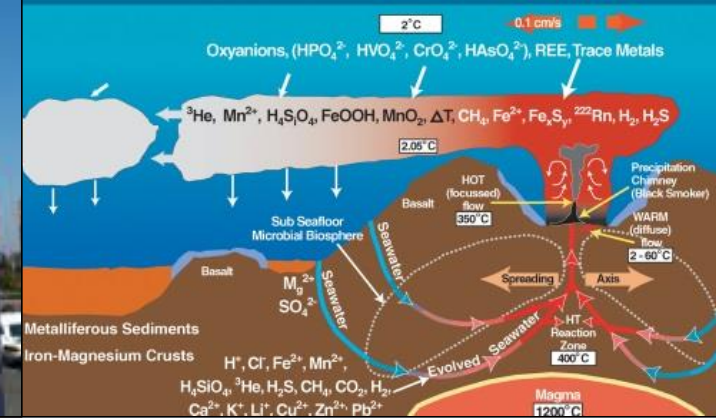

Systems: Big, Complex, and Challenging

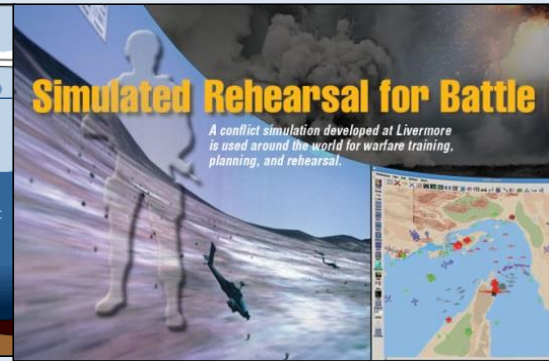
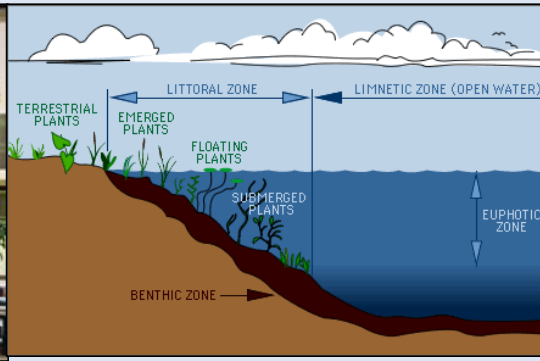

- Engineers and scientists are increasingly concerned with understanding or designing large, complex systems.
- Is current Systems Engineering up to this challenge?

Two “Phase Changes” in Technical Disciplines

1. Phase change leading to traditional STEM disciplines:
 - Beginning around 300 years ago (Newton’s time)
 - Evidence argued from efficacy step impact on human life

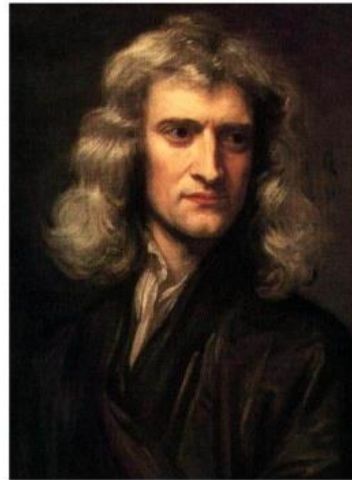

2. Phase change leading to future systems disciplines:
 - Beginning around our own time
 - Evidence argued from foundations of STEM disciplines

Phase Change 1 Evidence: Efficacy of Phenomena-Based STEM Disciplines



In a matter of a 300 years . . .

- the accelerating emergence of Science, Technology, Engineering, and Mathematics (STEM) . . .
- has lifted the possibility, quality, and length of life for a large portion of humanity . . .
- while dramatically increasing human future potential.
- By 20th Century close, strong STEM capability was recognized as a critical ingredient to individual and collective prosperity.

The length of human life has been dramatically extended:

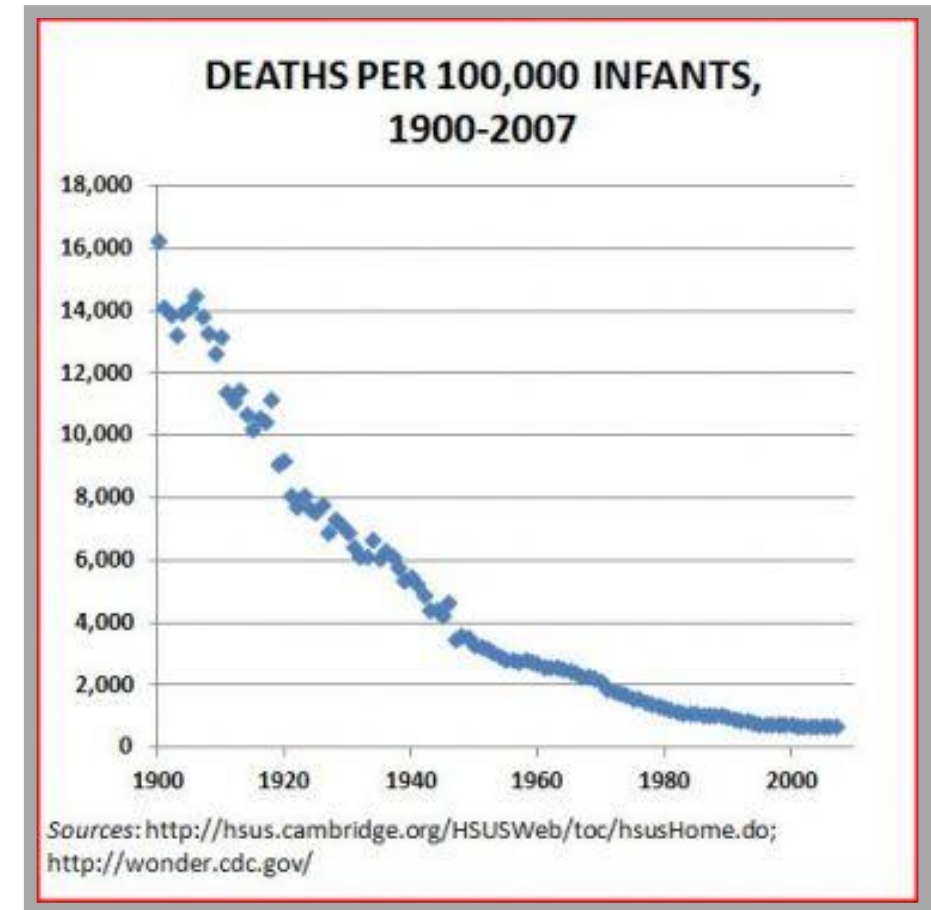
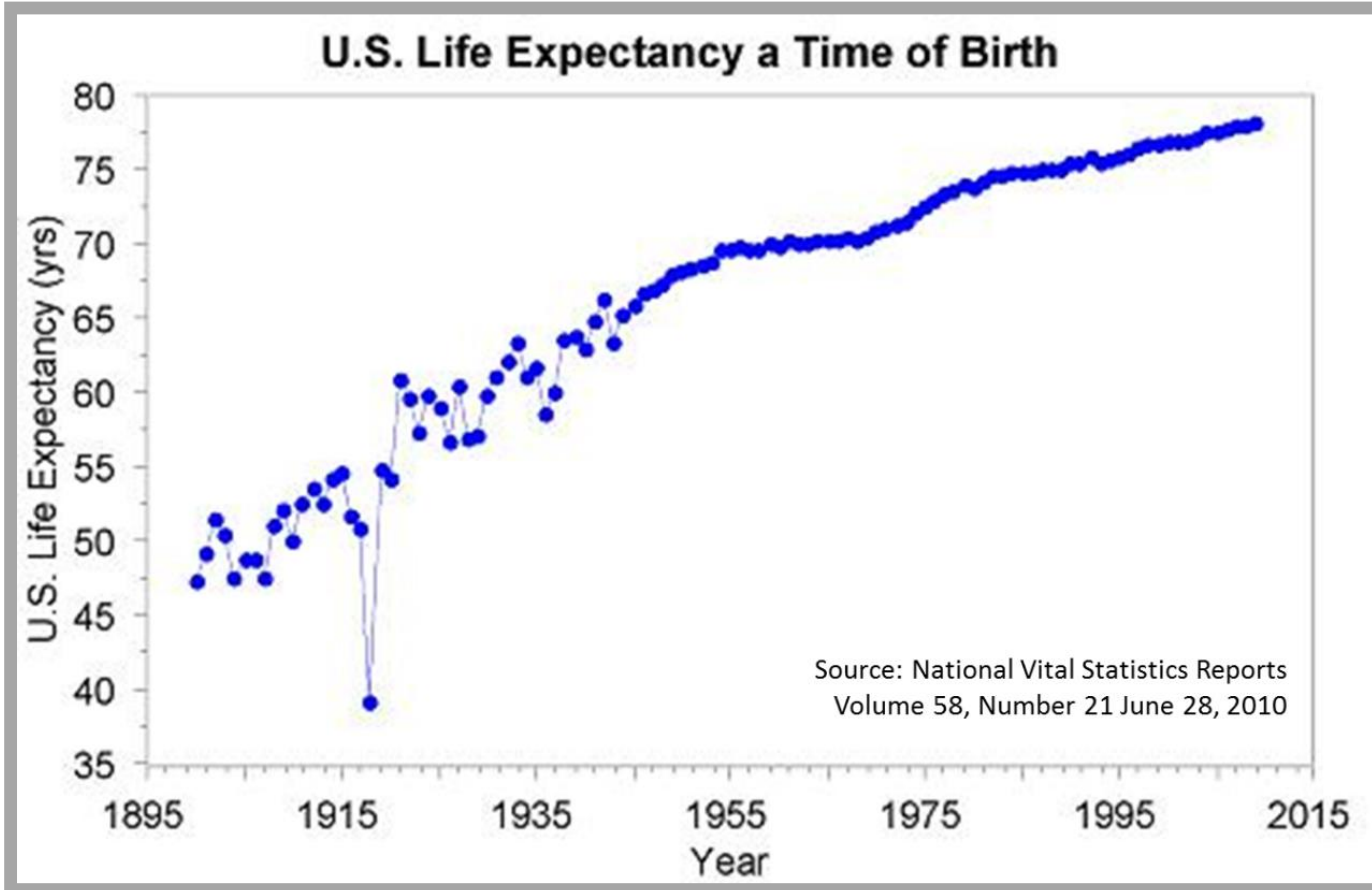

Simply feeding ourselves consumes less labor and time:

Food Expenditures Share of Disposable Personal Income 1929 - 2009

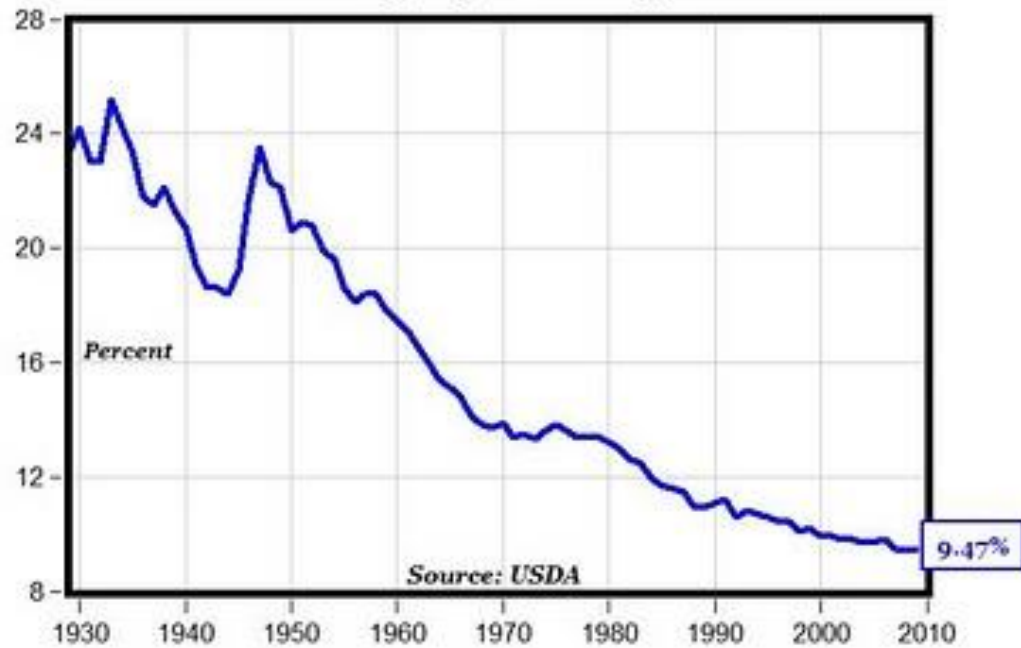

GDP per Capita of the US 1870 to 2011

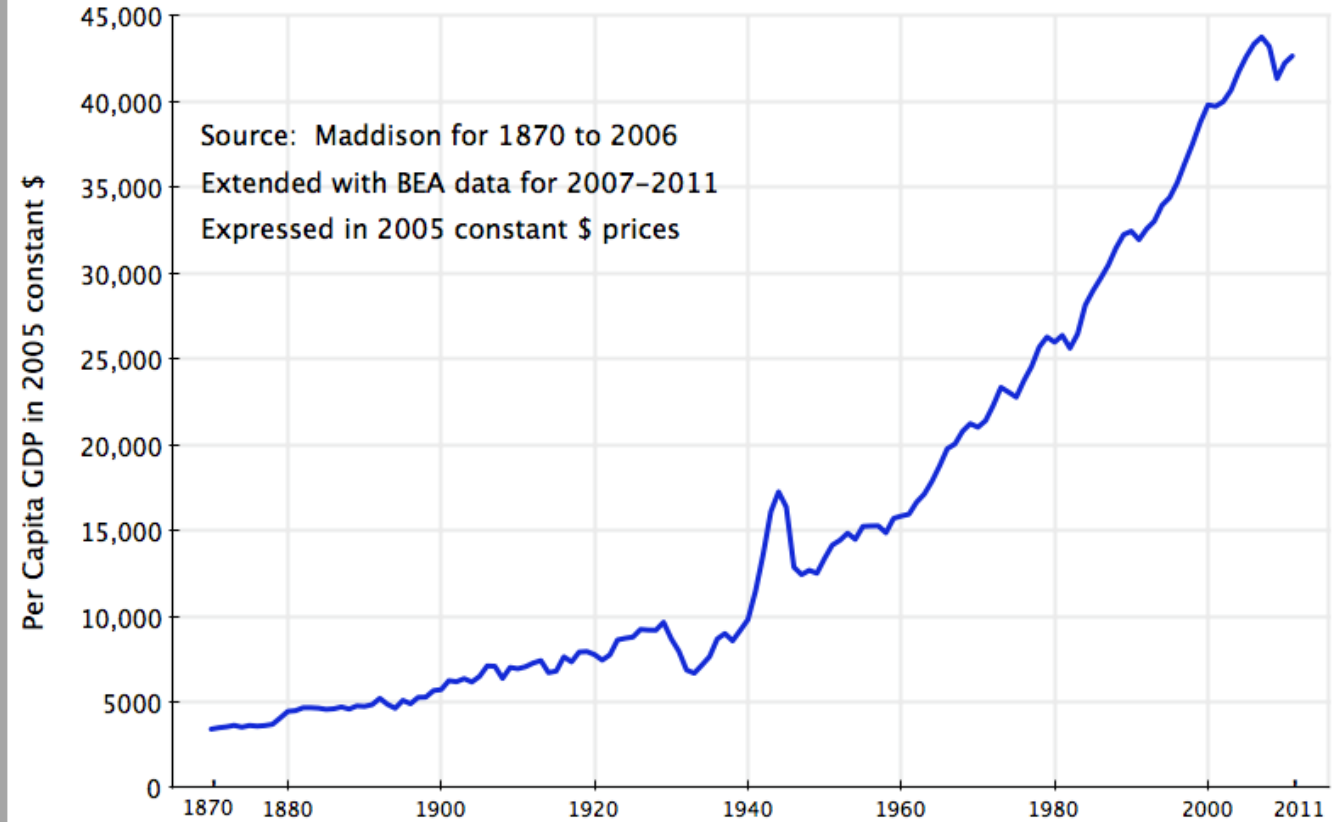

The range of individual human travel has vastly extended:

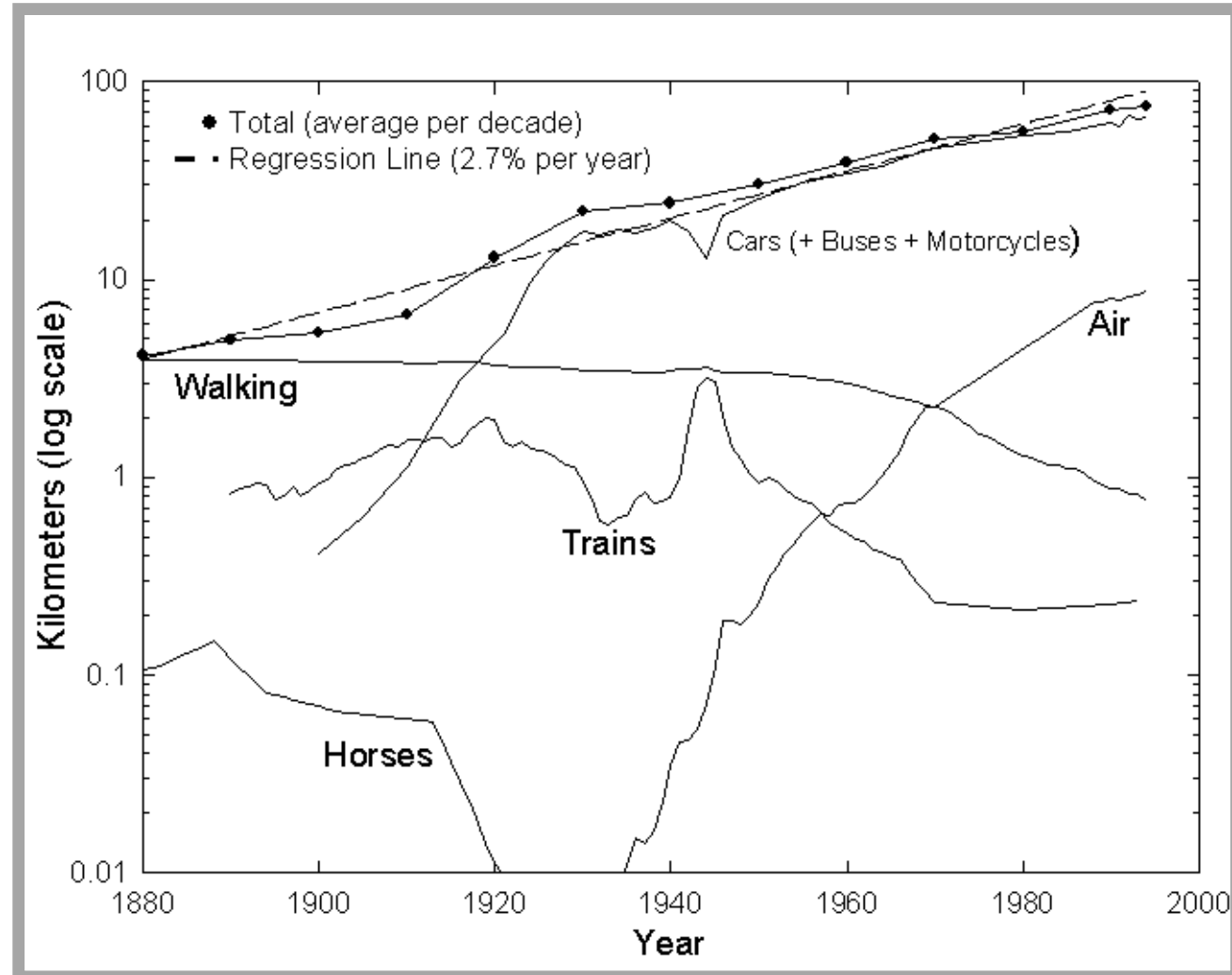

US passenger travel per capita per day by all modes.

Sources of data: Grubler , US Bureau of the Census , US Department of Transportation

Challenges Have Likewise Emerged



- In recent decades, the human-populated world has become vastly more interconnected, complex, and challenging . . .
- Offering both expanding opportunities and threats.
- From the smallest known constituents of matter and life, to the largest-scale complexities of networks, economies, the natural environment, and living systems . . .
- Understanding and harnessing the possibilities have become even more important than before.

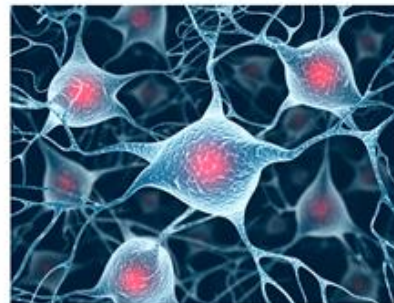

Systems progress has come with challenging side effects:

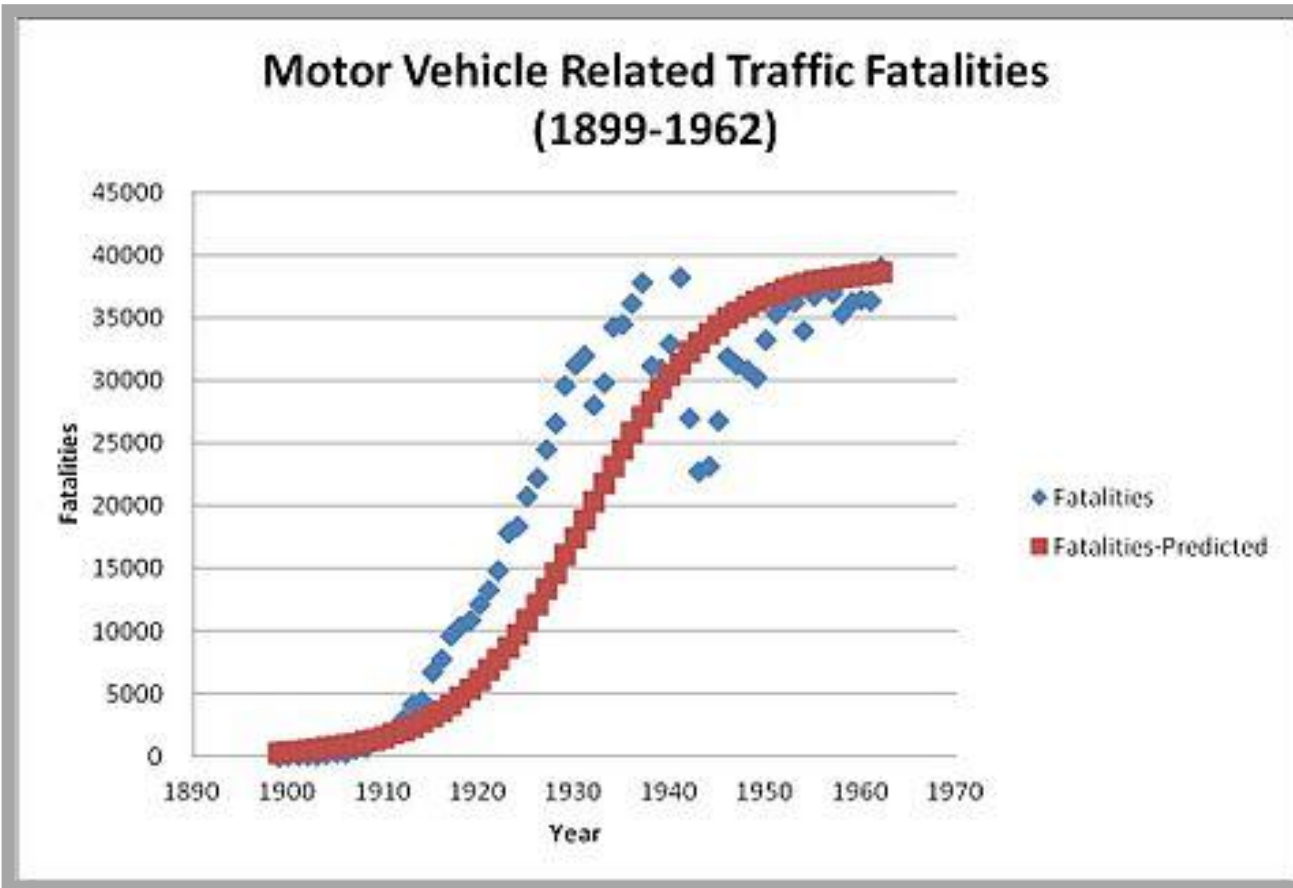

NHTSA and FHWA data

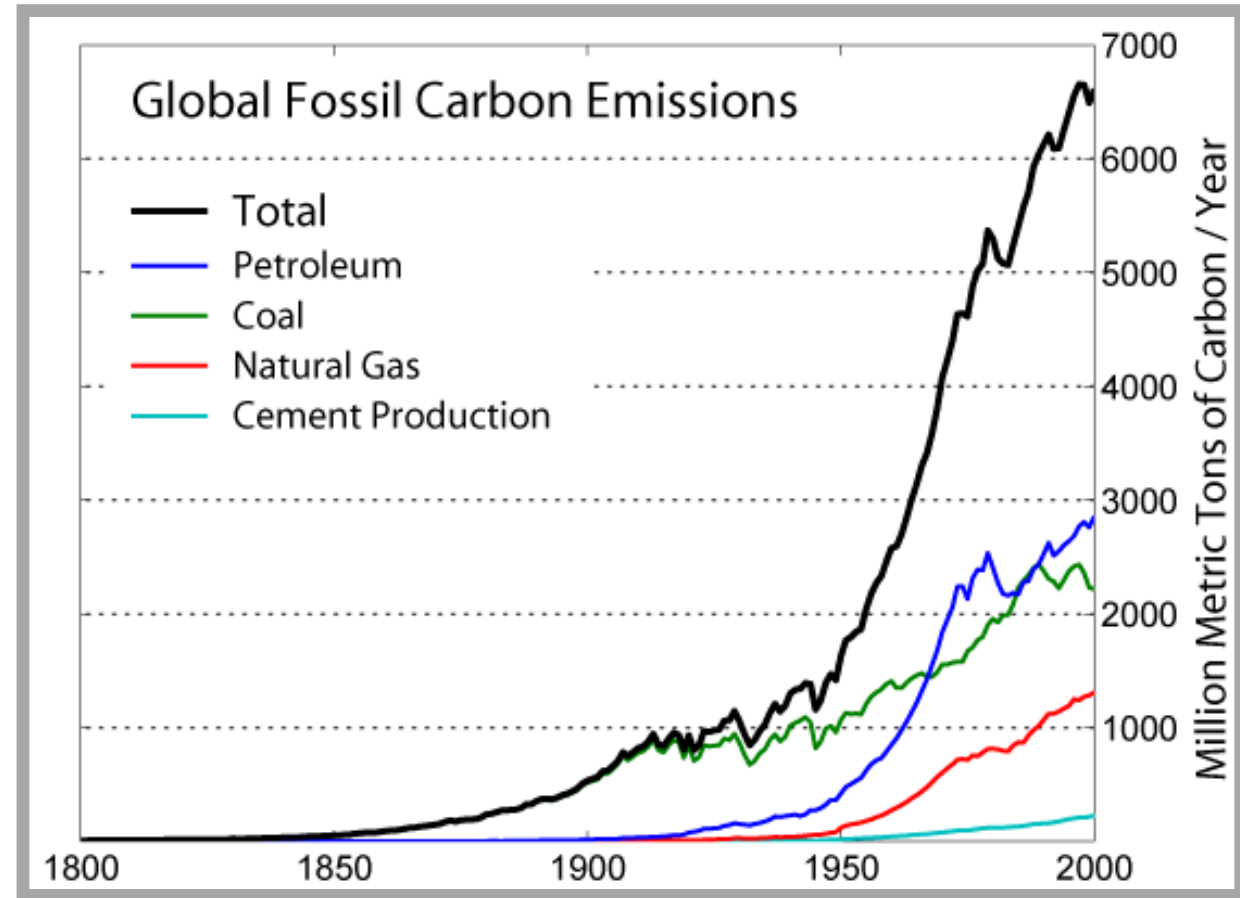

In Trends: A Compendium of Data on Global Change. [Carbon Dioxide Information Analysis Center](#), Oak Ridge National Laboratory, [United States Department of Energy](#), Oak Ridge, Tenn., U.S.A

Not all human progress has been STEM-driven

- For example, the spread of market capitalism can be argued to have also lifted human life.
- Nevertheless STEM has been a major contributor:

Impact	Notable STEM Drivers (samples)
Increased life expectancy	Life sciences, nutritional science
Reduced infant mortality	
Reduced food production cost	Agronomy, herbicides, fertilizers, mechanization
Increased GDP per capita	Mechanized production, mechanized distribution
Increased range of travel	Vehicular, civil, and aerospace engineering
Increased traffic fatalities	Vehicular engineering, civil engineering
Increased carbon emissions	Vehicular engineering; mechanized production

Emergence of Science and Engineering

- The “hard sciences”, along with the “traditional” engineering disciplines and technologies based on those sciences, may be credited with much of this amazing progress, as well as challenges.
- How should Systems Engineering be compared to engineering disciplines based on the “hard sciences”?

Phenomena-Base Engineering Disciplines

- The traditional engineering disciplines have their technical bases and quantitative foundations in the hard sciences:

Engineering Discipline	Phenomena	Scientific Basis	Representative Scientific Laws
Mechanical Engineering	Mechanical Phenomena	Physics, Mechanics, Mathematics, . . .	Newton's Laws
Chemical Engineering	Chemical Phenomena	Chemistry, Mathematics. . . .	Periodic Table
Electrical Engineering	Electromagnetic Phenomena	Electromagnetic Theory	Maxwell's Equations, etc.
Civil Engineering	Structural Phenomena	Materials Science, . . .	Hooke's Law, etc.

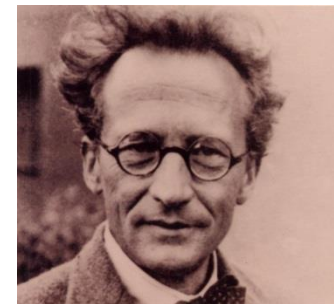
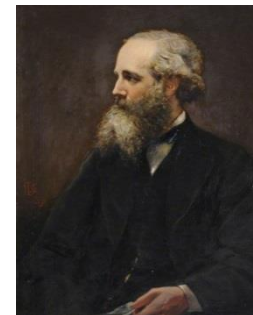
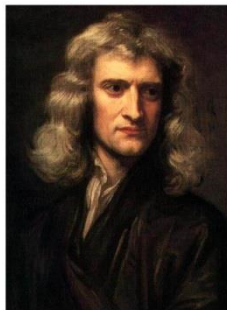

The Traditional Perspective

- Specialists in individual engineering disciplines (ME, EE, CE, ChE, etc.) sometimes argue that their fields are based on:
 - “real physical phenomena”,
 - physical laws based in the “hard sciences”, and first principles,
- sometimes claiming that Systems Engineering lacks the equivalent phenomena based theoretical foundation.

$$\begin{aligned}\nabla \cdot \mathbf{D} &= \rho \\ \nabla \cdot \mathbf{B} &= 0 \\ \nabla \times \mathbf{E} &= -\frac{\partial \mathbf{B}}{\partial t} \\ \nabla \times \mathbf{H} &= \mathbf{J} + \frac{\partial \mathbf{D}}{\partial t}\end{aligned}$$

$$\frac{N_b}{N_a} = \left(\frac{g_b}{g_a}\right) e^{-(E_b - E_a)/kT}$$

$$H(t)|\psi(t)\rangle = i\hbar \frac{\partial}{\partial t} |\psi(t)\rangle$$

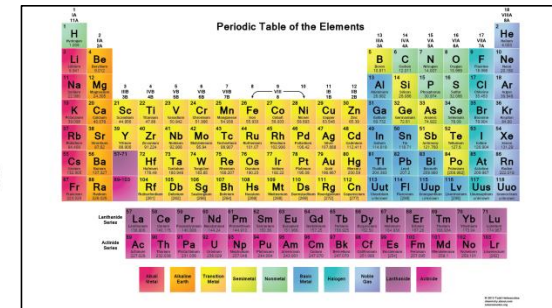

Periodic Table of the Elements

A standard periodic table of elements, color-coded by groups. The table includes all elements from Hydrogen (H) to Oganesson (Og), with the Lanthanide and Actinide series shown below the main table.

- Instead, Systems Engineering is sometimes viewed as:
 - Emphasizing process and procedure
 - Critical thinking and good writing skills
 - Organizing and accounting for information
- But not based on an underlying “hard science”

Traditional Perspective, continued

- That view is perhaps understandable, given the first 50 years of Systems Engineering
- “Science” or “phenomenon” of generalized systems have for the most part been described on an intuitive basis, with limited reference to a “physical phenomenon” that might be called the basis of systems science and systems engineering:
 - For example, emergence of patterns out of agent interactions in complex systems
 - Fascinating, but not yet the basis of generations of life-changing human progress such as has marked the last 300 years

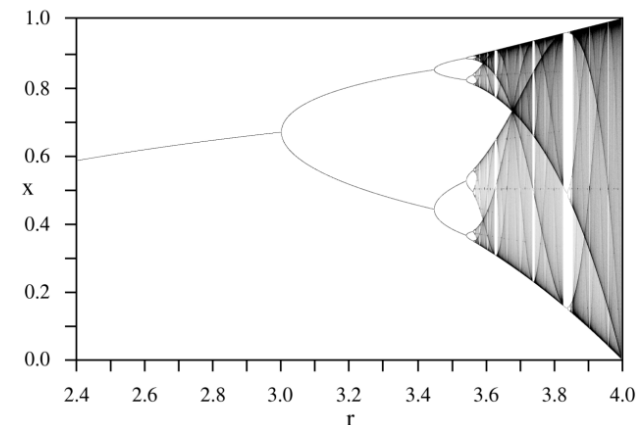

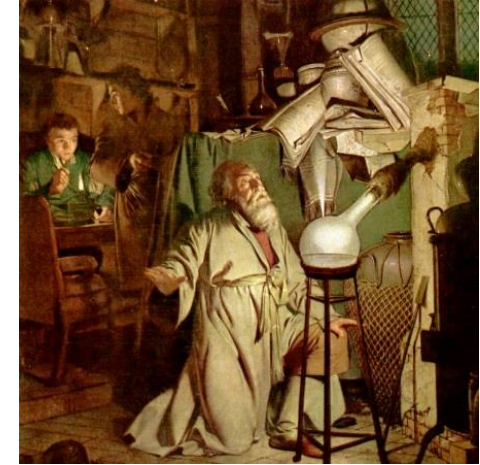
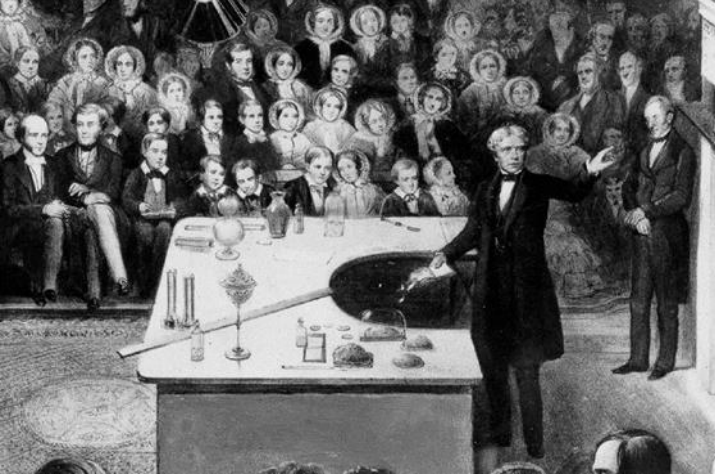

However . . .

- The same might be said of physics before Newton, chemistry before Lavoisier & Mendeleev, electrical science before Faraday & Maxwell, etc.
- Moreover, Systems Engineering is also undergoing a “phase change” that might be compared to the emergence of phenomena understanding in the other engineering disciplines . . .

MBSE, PBSE: A Phase Change in Systems Engineering

While models are not new to STEM . . .

- Model- Based Systems Engineering (MBSE): We increasingly represent our understanding of systems aspects using explicit models.
- Pattern-Based Systems Engineering (PBSE): We are beginning to express parameterized family System Models capable of representing recurring patterns.
- This is a much more significant change than just the emergence of modeling languages and IT toolsets, provided the underlying model structures are strong enough:
 - Remember physics before Newtonian calculus
 - We assert here the need to use mathematical patterns known 100 years

The System Phenomenon

- In the perspective described here, by system we mean a collection of interacting components:

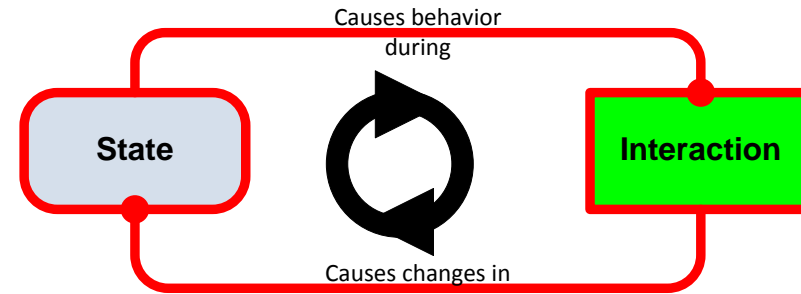
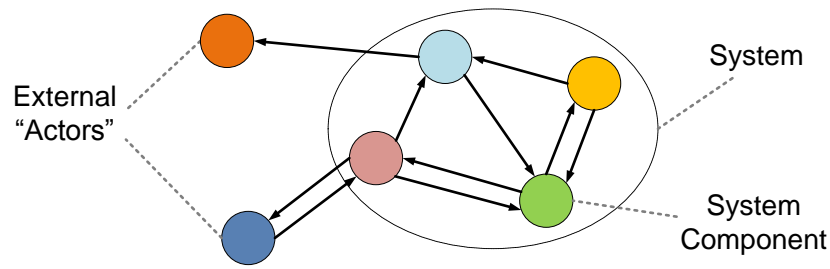

- Where interaction involves the exchange of energy, force, mass, or information, . . .
- Through which one component impacts the state of another component, . . .
- And in which the state of a component impacts its behavior in future interactions.

The System Phenomenon

- Phenomena of the hard sciences are in each case instances of the following “System Phenomenon”:
 - *behavior emergent from the interaction of behaviors (phenomena themselves) a level of decomposition lower.*
- In each such case, the emergent interaction-based behavior of the larger system is a stationary path of the action integral:

$$S = \int_{t_1}^{t_2} L(x, \dot{x}, t) dt$$

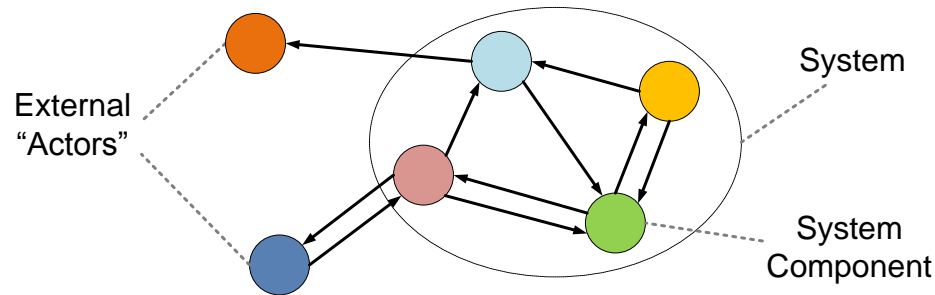

←

(Hamilton's Principle)

- Reduced to simplest forms, the resulting equations of motion (or if not solvable, empirically observed paths) provide “physical laws” subject to scientific verification.

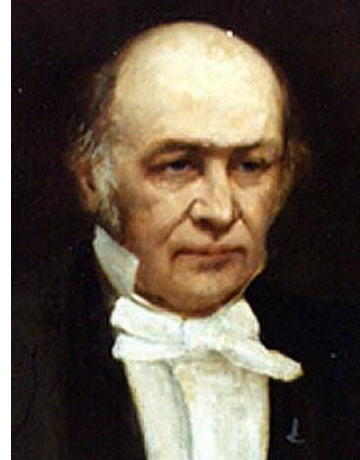

Hamilton's Principle: Root of Equations of Motion for All Interactive Phenomena (Dynamics)

- Hamilton's Principle: Stated in language of mathematics (calculus of variations, not just prose heuristics or philosophy):
 - Basis of equations of motion (dynamical configuration change) in system state configuration phase space.
 - The source of derivation of the “specific phenomena” mathematics, such as Maxwell's Equations, Newton's Laws/Mechanics, Quantum Mechanics (i.e., Path Integral formulation), etc.
 - Even when we cannot solve the resulting equations (laws), they are the basis of simulations, in particular HPC computational models (e.g., computational chemistry based on Schrödinger eqn., etc.)

Emmy Noether
Germany and USA
1882-1935



Noether's Theorem: Symmetries, Emergent Invariants and Conservation Laws

- Noether's Theorem: Shows us that . . .
 - In the presence of continuous symmetry (e.g., time translation, spatial translation, rotational translation, etc.), . . .
 - Hamilton's Principle will apply and . . .
 - There will be invariant (conserved) emergent quantities (integrals of motion), e.g., energy, momentum (linear and rotational), etc.

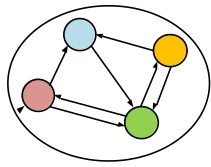

The System Phenomenon

- Instead of Systems Engineering lacking the kind of theoretical foundation that the “hard sciences” bring to other engineering disciplines, . . .
 - It turns out that all those other engineering disciplines’ foundations are themselves dependent upon the System Phenomenon.
 - The underlying math and science of systems provides the theoretical basis already used by all the hard sciences and their respective engineering disciplines.
 - It is not Systems Engineering that lacks its own foundation—instead, it has been providing the foundation for the other disciplines!

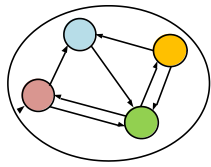

The System Phenomenon

A traditional view:

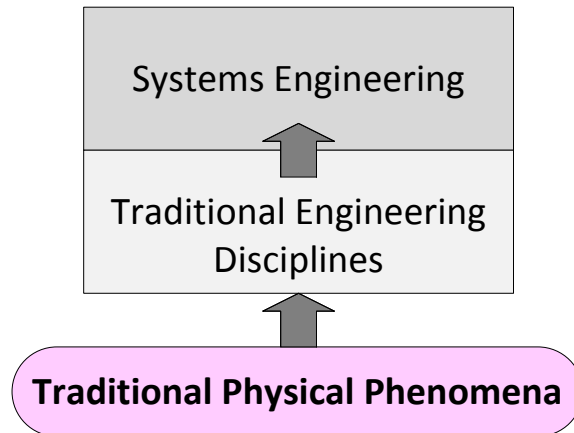

Our view:

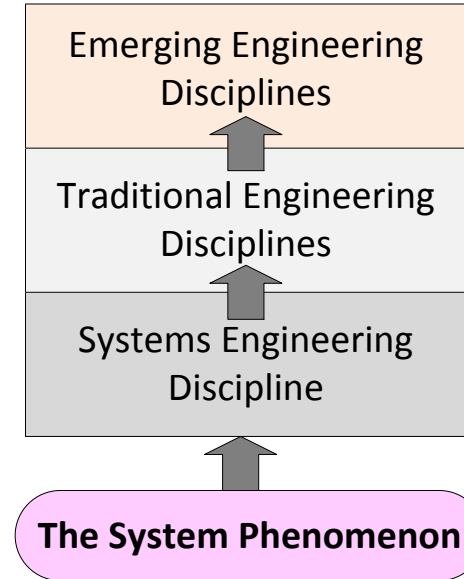

- It is not Systems Engineering that lacks its own foundation—instead, it has been providing the foundation for the other disciplines!

Historical Example 1: Chemistry



Priestley : Oxygen

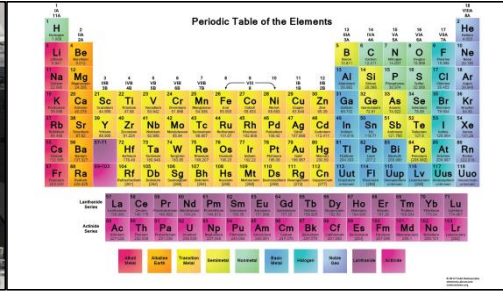

Modern Chemist

A standard periodic table of elements, color-coded by groups. The title "Periodic Table of the Elements" is at the top. The table includes elements from Hydrogen (H) to Oganesson (Og), with Lanthanide and Actinide series shown below the main table.

Periodic Table of the Elements

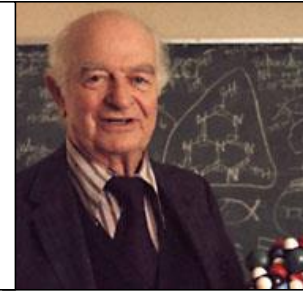

Pauling: Chemical Bond



Mendeleev: Periodic Table

- Chemists, and Chemical Engineers, justifiably consider their disciplines to be based on the “hard phenomena” of Chemistry:
 - A view that emerged from the scientific discovery and verification of laws of Chemistry.
 - Chemical Elements and their Chemical Properties, organized by the discovered patterns of the Periodic Table.
 - Chemical Bonds, Chemical Reactions, Reaction Rates, Chemical Energy, Conservation of Mass and Energy.
 - Chemical Compounds and their Properties.

Chemistry, continued

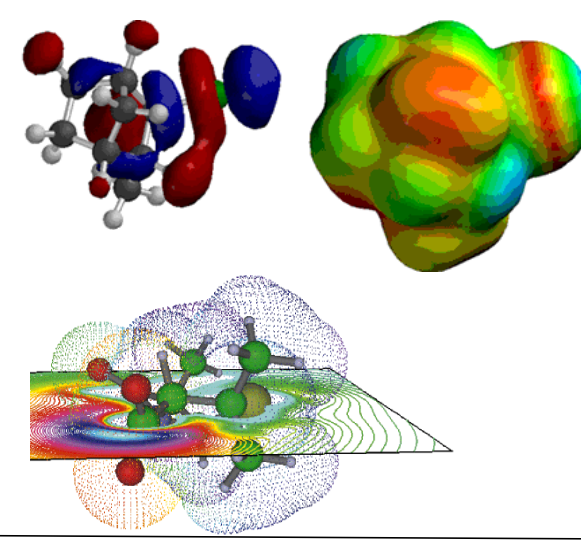
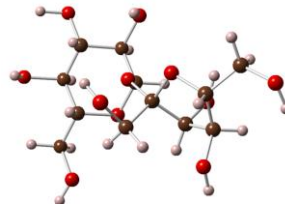
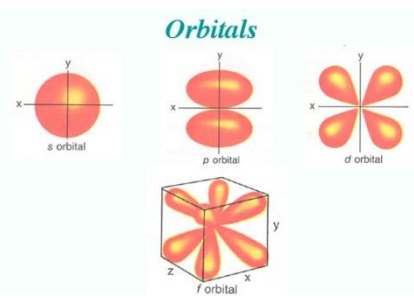
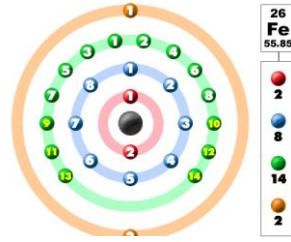
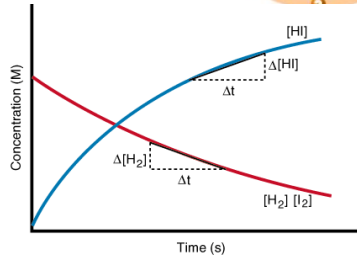
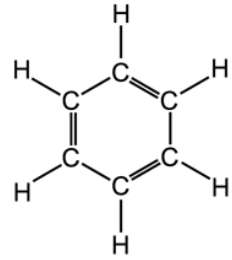

However . . .

- All those chemical properties and behaviors are emergent consequences of interactions that occur between atoms' orbiting electrons (or their quantum equivalents), along with the rest of the atoms they orbit.
- These lower level interactions give rise to patterns that have their own higher level properties and relationships, expressed as "hard science" laws.

Chemistry, continued

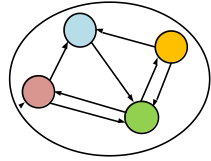

So . . .



- The “fundamental phenomena” of Chemistry, along with the scientifically-discovered / verified “fundamental laws / first principles” are in fact . . .
- Higher level emergent system patterns and . . .
- Chemistry and Chemical Engineering study and apply those system patterns.



Boyle

Historical Example 2: The Gas Laws and Fluid Flow



Daniel Bernoulli

- The discovered and verified laws of gases and of compressible and incompressible fluid flow by Boyle, Avogadro, Charles, Gay-Lussac, Bernoulli, and others are rightly viewed as fundamental to science and engineering disciplines.

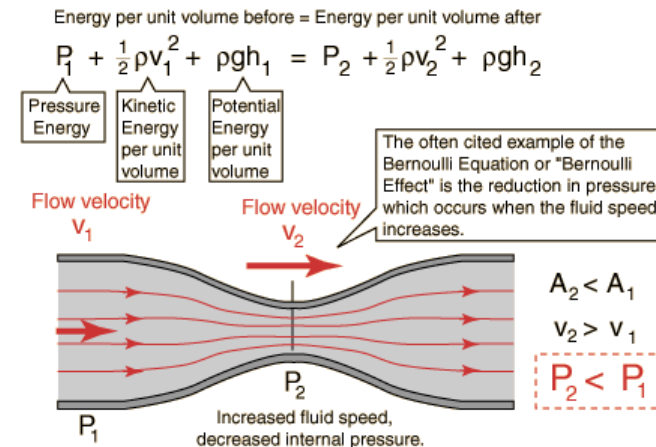
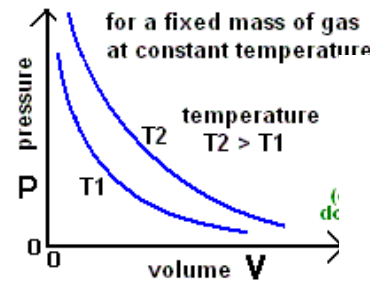
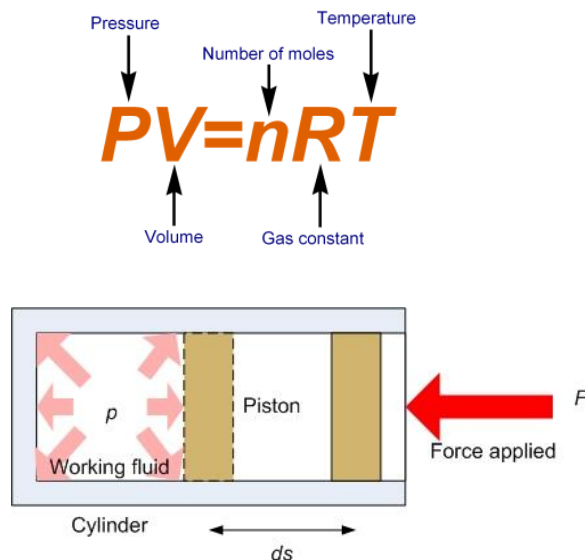

Gas Laws, continued

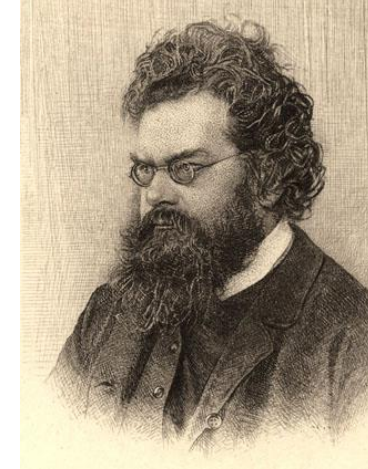
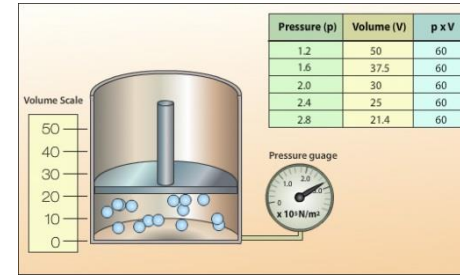
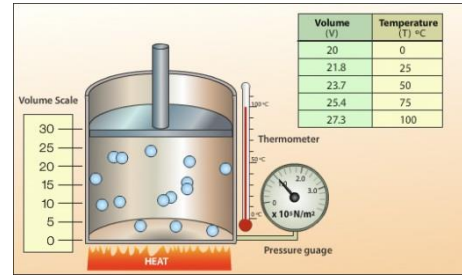
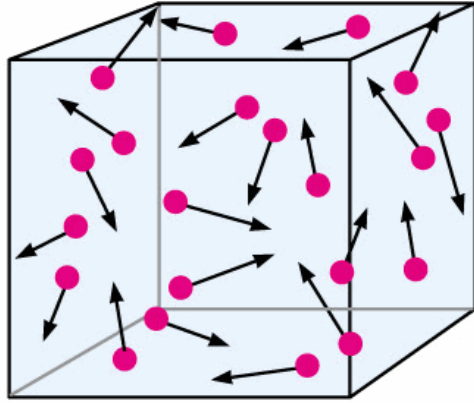

Boltzmann

$$\frac{N_b}{N_a} = \left(\frac{g_b}{g_a}\right) \left(e^{-(E_b - E_a)/kT}\right)$$

However . . .

- All those gaseous properties and behaviors are emergent consequences of interactions that occur between atoms or molecules, and the containers they occupy, and the external thermal environment
- These lower level interactions give rise to patterns that have their own higher level properties and relationships, expressed as “hard sciences” laws.

Gas Laws, continued

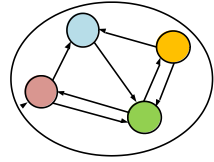

So . . .

- The “fundamental phenomena” of gases, along with the scientifically-discovered / verified “fundamental laws and first principles” are in fact . . .
- higher level emergent system patterns so that . . .
- Mechanical Engineers, Thermodynamicists, and Aerospace Engineers can study and apply those system patterns.

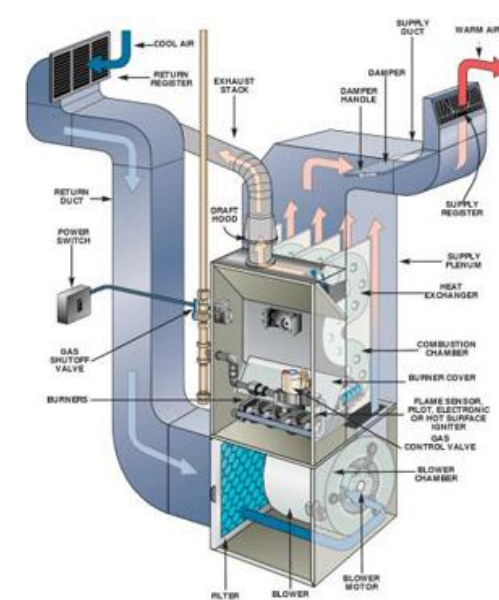

More Recent Historical Examples

- Ground Vehicles
- Aircraft
- Marine Vessels
- Biological Regulatory Networks

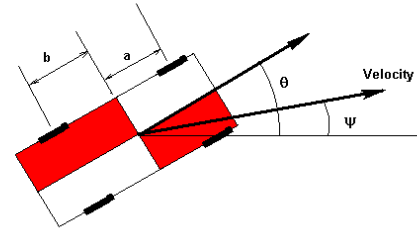

Dynamics of Road Vehicle

Denoting the angular velocity ω , the equations of motion are:

$$\frac{d\omega}{dt} = 2k \frac{(a-b)}{I} (\theta - \psi) - 2k \frac{(a^2 + b^2)}{VI} \omega$$

$$\frac{d\theta}{dt} = \omega$$

$$\frac{d\psi}{dt} = \frac{4k}{MV} (\theta - \psi) + 2k \frac{(b-a)}{MV^2} \omega$$

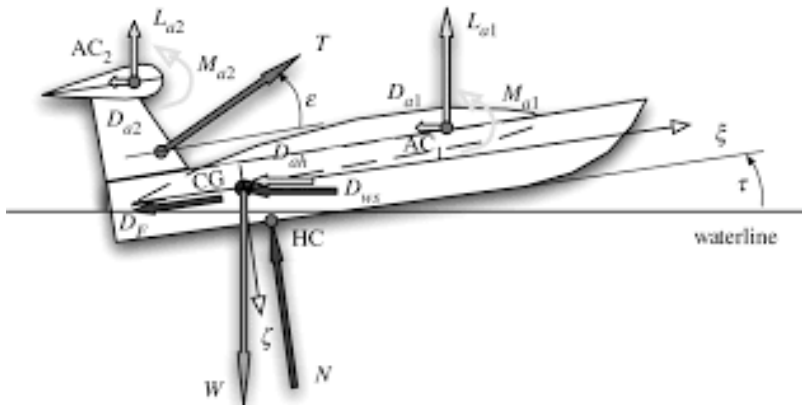

NASA Glenn Research Center

Forces in a Climb

climb angle = c

m = aircraft mass
 a = acceleration

L = Lift
 D = Drag
 W = Weight
 F = Thrust

Equations:

$$L \cos(c) + F \sin(c) - D \sin(c) - W = m a_{\text{Vertical}}$$

$$F \cos(c) - L \sin(c) - D \cos(c) = m a_{\text{Horizontal}}$$

Definition of Excess Thrust: $F - D = F_{\text{ex}}$

$$L \cos(c) + F_{\text{ex}} \sin(c) - W = m a_{\text{Vertical}}$$

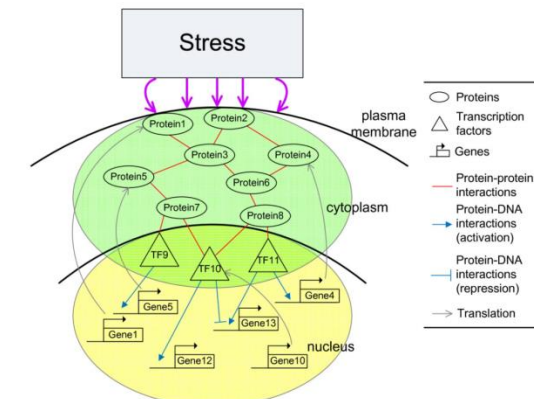
$$F_{\text{ex}} \cos(c) - L \sin(c) = m a_{\text{Horizontal}}$$

Future Applications

- Utility and other distribution networks
- Biological organisms and ecologies
- Market systems and economies
- Health care delivery, other societal services
- Systems of conflict
- Agile innovation

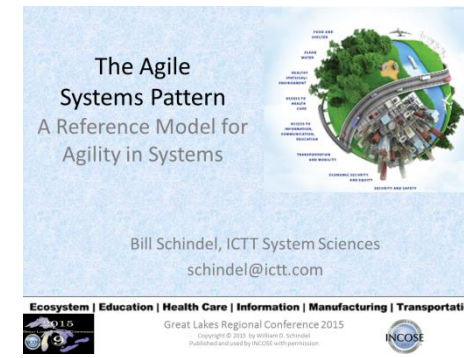
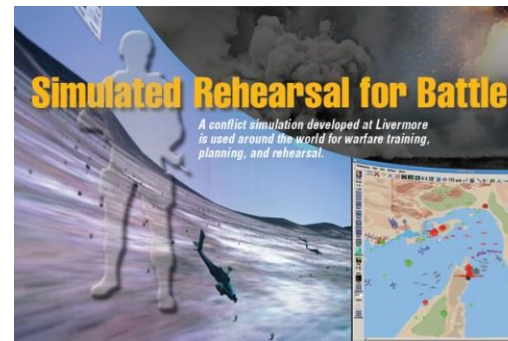
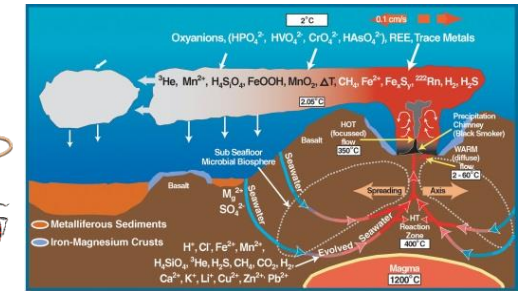
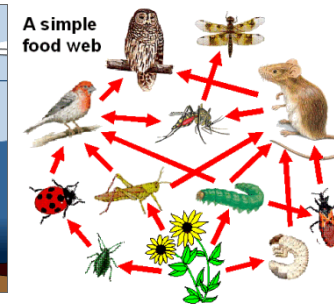
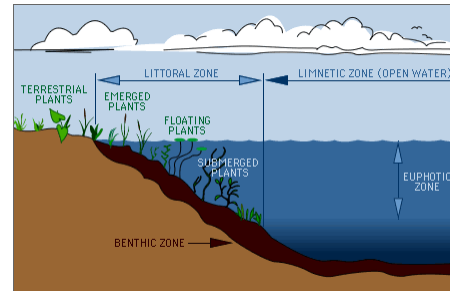

Strengthening the Foundations of MBSE

- Model-Based Systems Engineering requires a strong enough underlying Metamodel and Systems Science to equip it for the challenges and opportunities of these higher level systems.
- Example: The model framework of behavior emerging from interactions is at the center of the S*Metamodel framework:

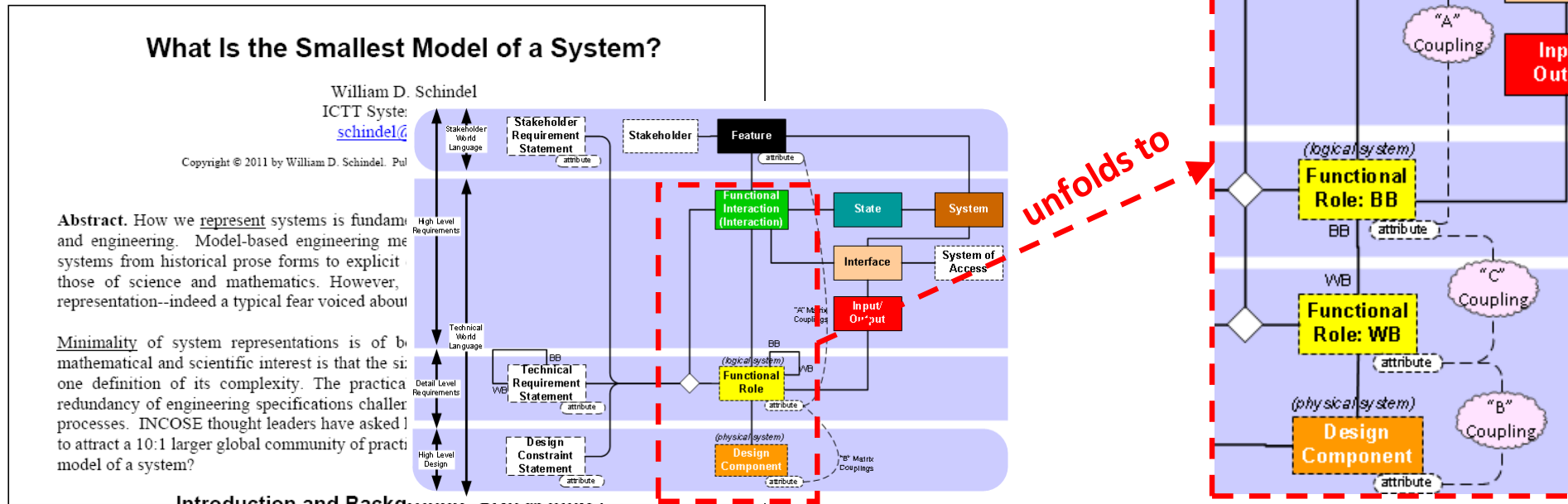

An illustration of Related SE Impact: Design Review

- Model-Based Design Review:
 - An example of beneficial impact of the System Phenomenon viewpoint
- Poses six key questions for any Design Review
 - To determine if a candidate design is likely to satisfy system requirements
- Note Question 2, comparing Black Box behavior that emerges from White Box interactions.
- Whether viewed as composition (bottoms up) or decomposition (top down) . . .

Six Questions for Design Review:

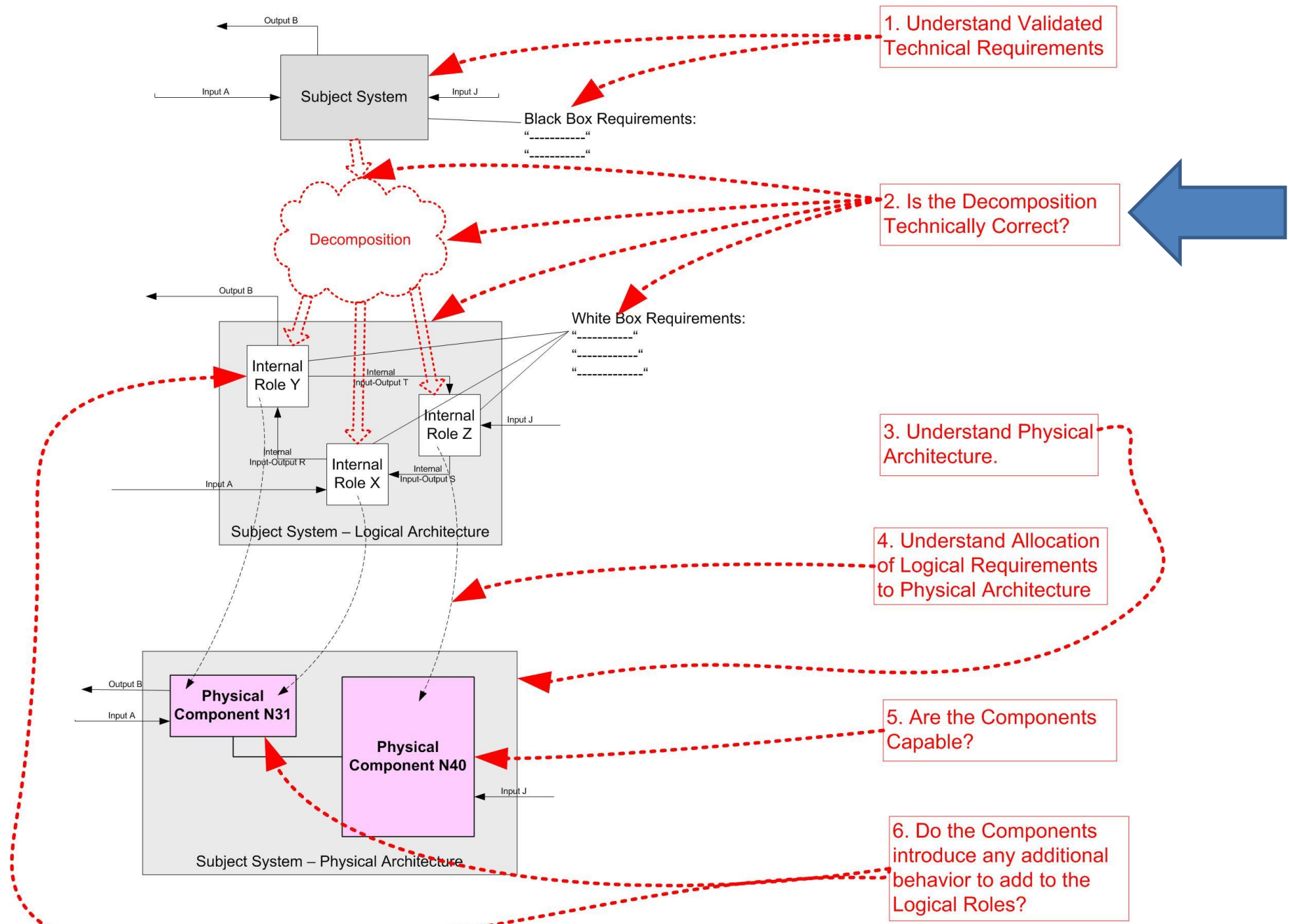

S* Metamodel

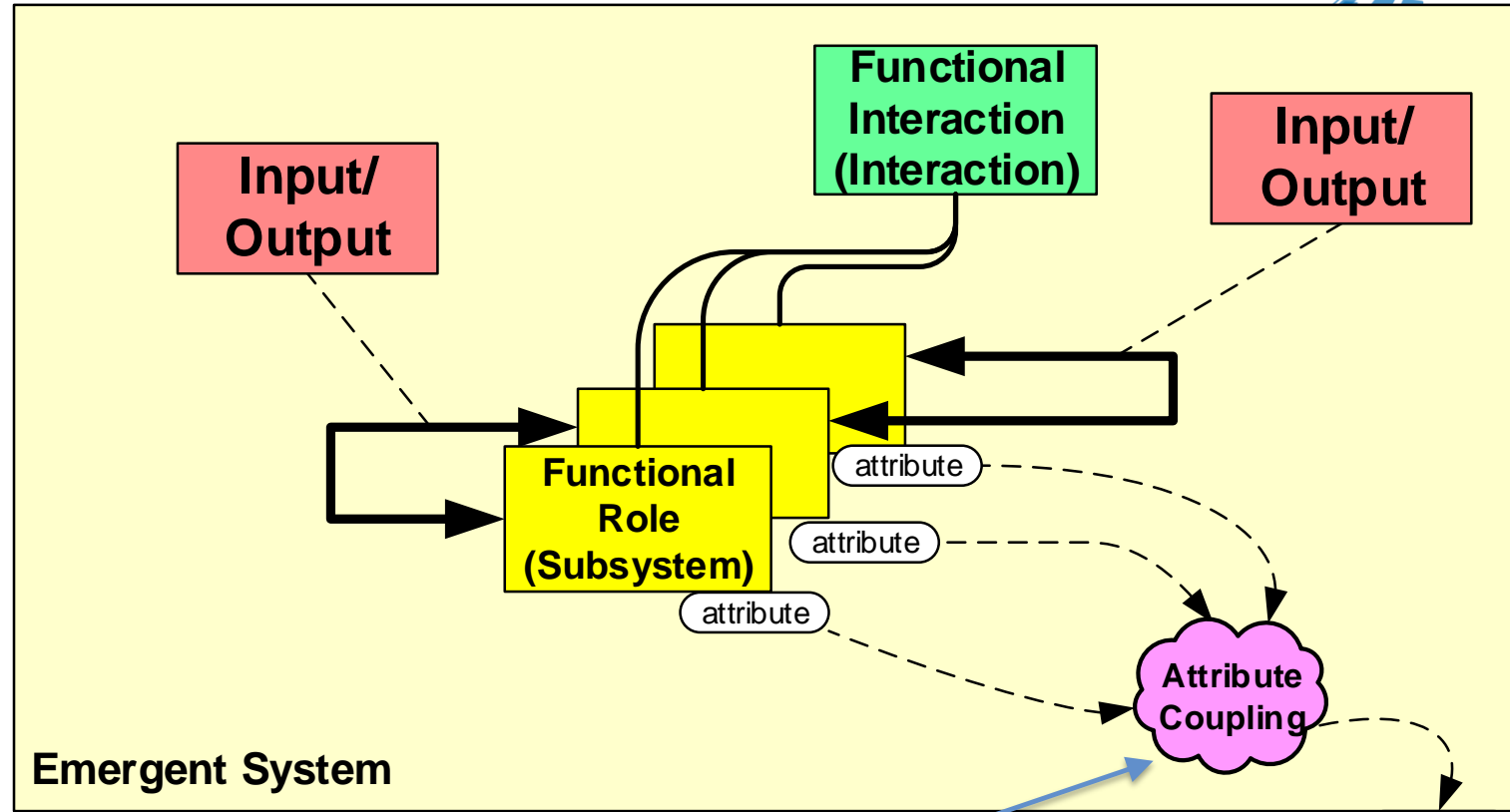
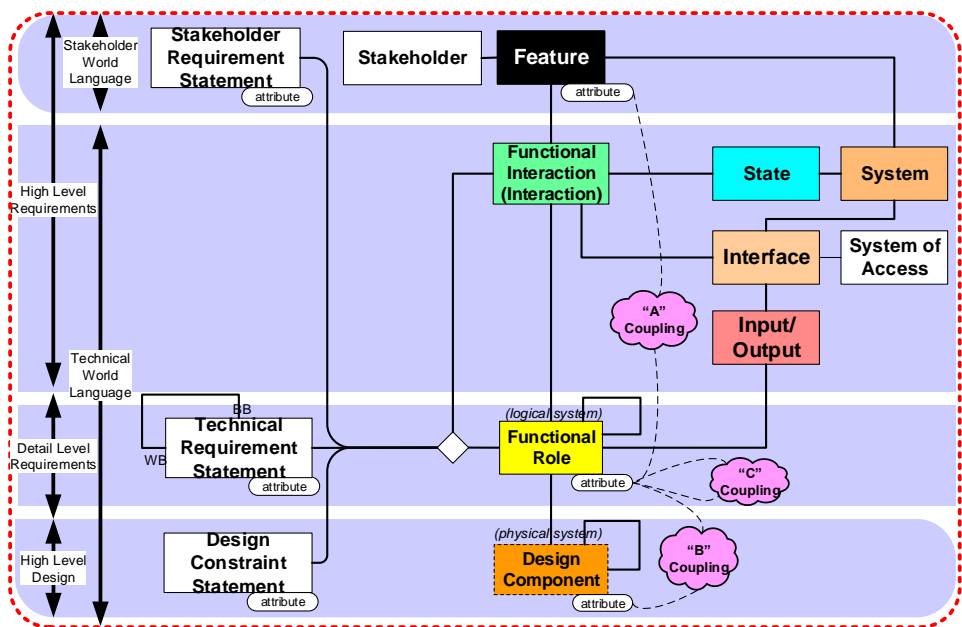

Governed by Hamilton's Principle

Emergent, in some cases conserved, properties—Noether's Theorem



Not only the basis for symbolic equations, but also practical simulations, when not solvable by symbolic means:

energytech 2017

A Lagrangian Approach to Modeling, Simulating and Controlling Dynamics of Turboelectric Distributed Propulsion (TeDP)

Dr. Marija Ilic

Senior Staff, Energy Systems Group 73, Lincoln Laboratory,
Massachusetts Institute of Technology ilic@mit.edu

Professor Emeritus, Carnegie Mellon University milic@andrew.cmu.edu



The foregoing was about dynamics of a given system.
But, where do systems come from, and where to they go?

	<p>27th annual INCOSE International Symposium Adelaide, Australia July 15 - 20, 2017</p>	
<p>Innovation, Risk, and Agility, Viewed as Optimal Control & Estimation</p>		
<p>Bill Schindel ICTT System Sciences schindel@icct.com</p>		
<p>Copyright © 2017 by William D. Schindel. Published and used by INCOSE with permission 1.7.2</p>		

Universal systems nomenclature, domain-independent.

Emergence of Patterns from Patterns: S*Pattern Class Hierarchy

More General
↓
More Specific

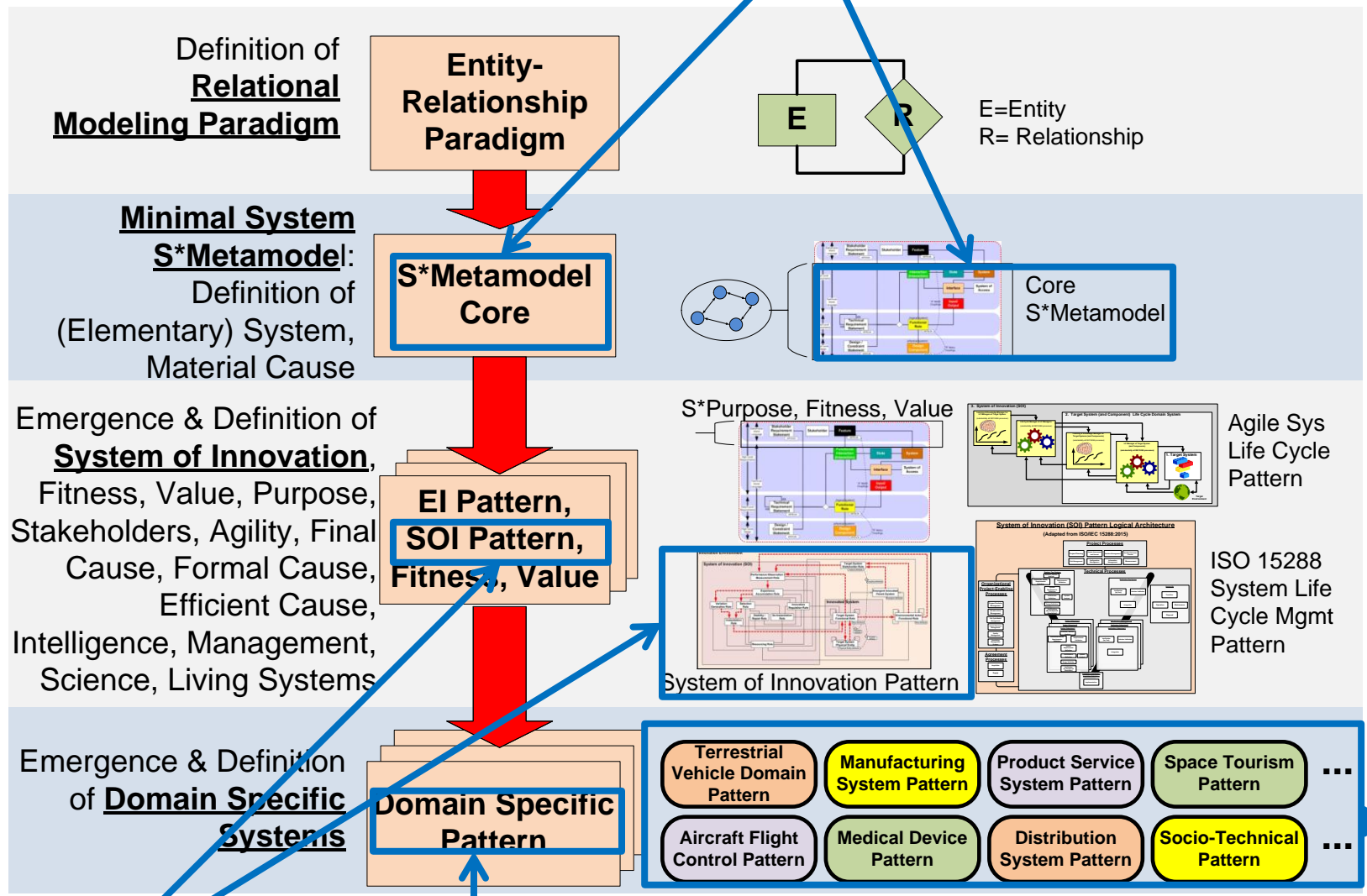

Domain-specific languages, frameworks, ontologies.

Generator of “new systems”; also maintainer, destroyer

ISO15288 and INCOSE SE Handbook describe a framework of ~32 roles of system Life Cycle (LC) Management.

System of Innovation (SOI) Pattern Logical Architecture

(Adapted from ISO/IEC 15288:2015)

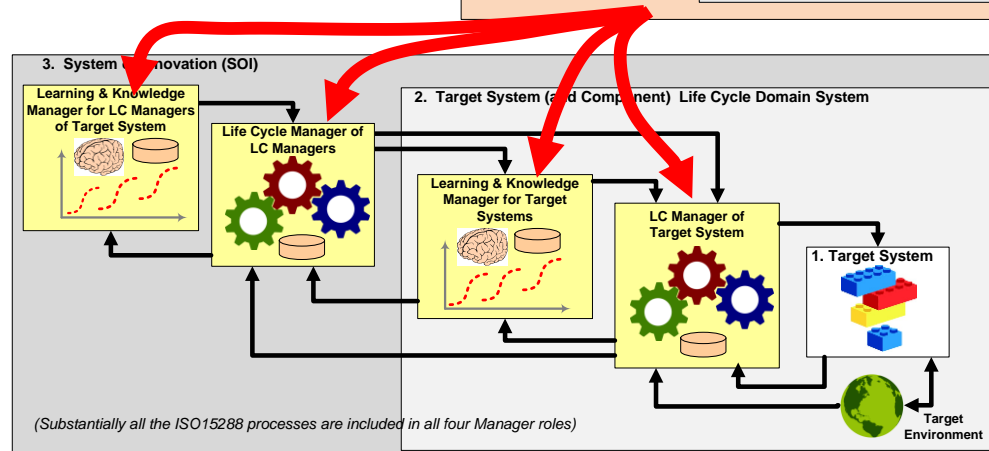
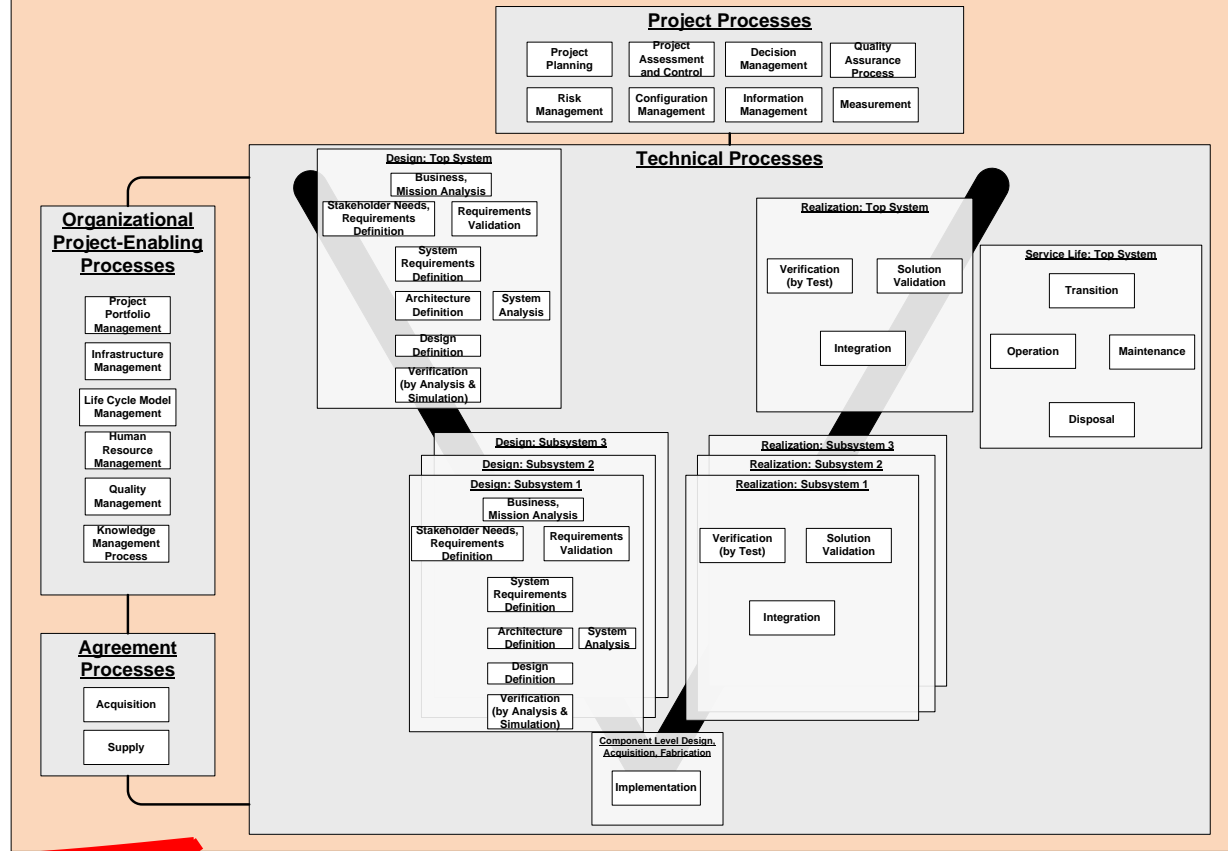

They appear repeatedly, in different ways in the SOI & ASELCM Patterns .

• • • • •

INCOSE Agile System Life Cycle Pattern: Application of System of Innovation (SOI) Pattern

- A complex adaptive system reference model for system innovation, adaptation, sustainment, retirement.
- Whether 100% human-performed or automation aided.
- Whether performed with agility or not, 15288 compliant or not, informal, scrum...
- Whether performed well or poorly.
- Includes representation of pro-active, anticipatory systems.

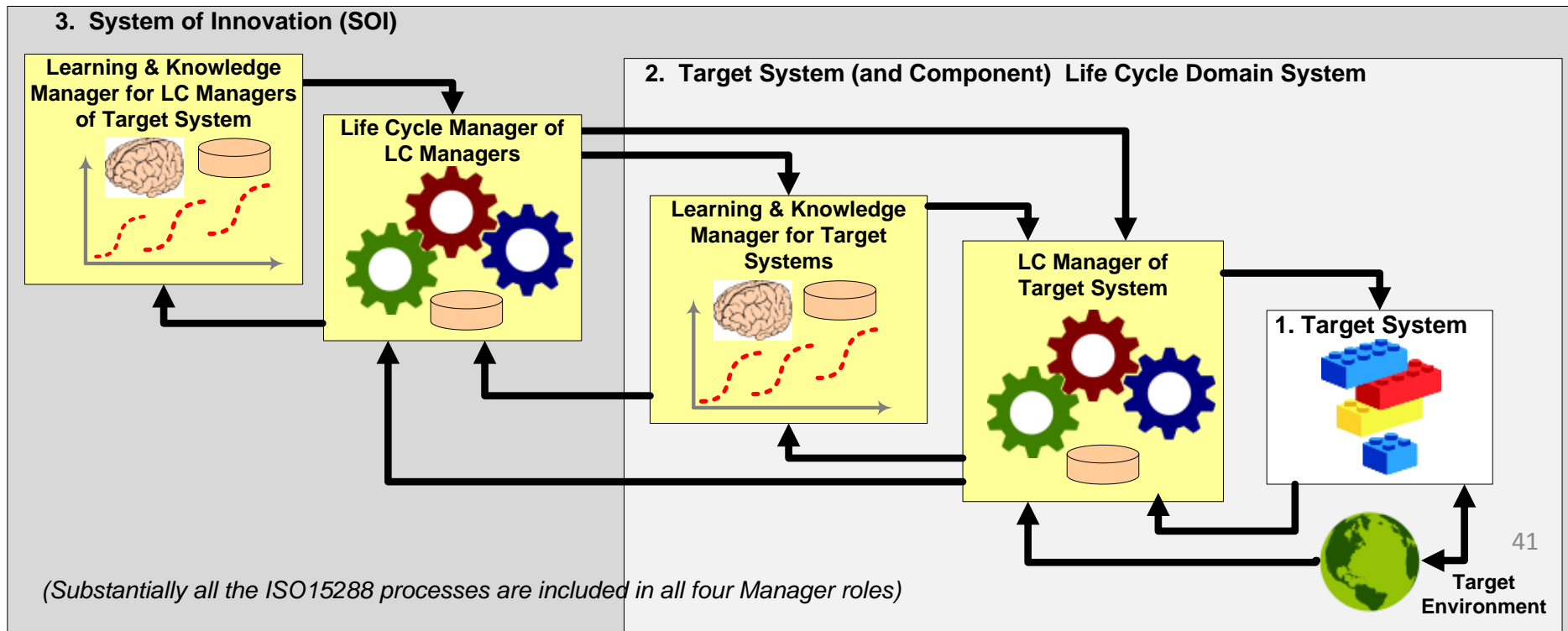

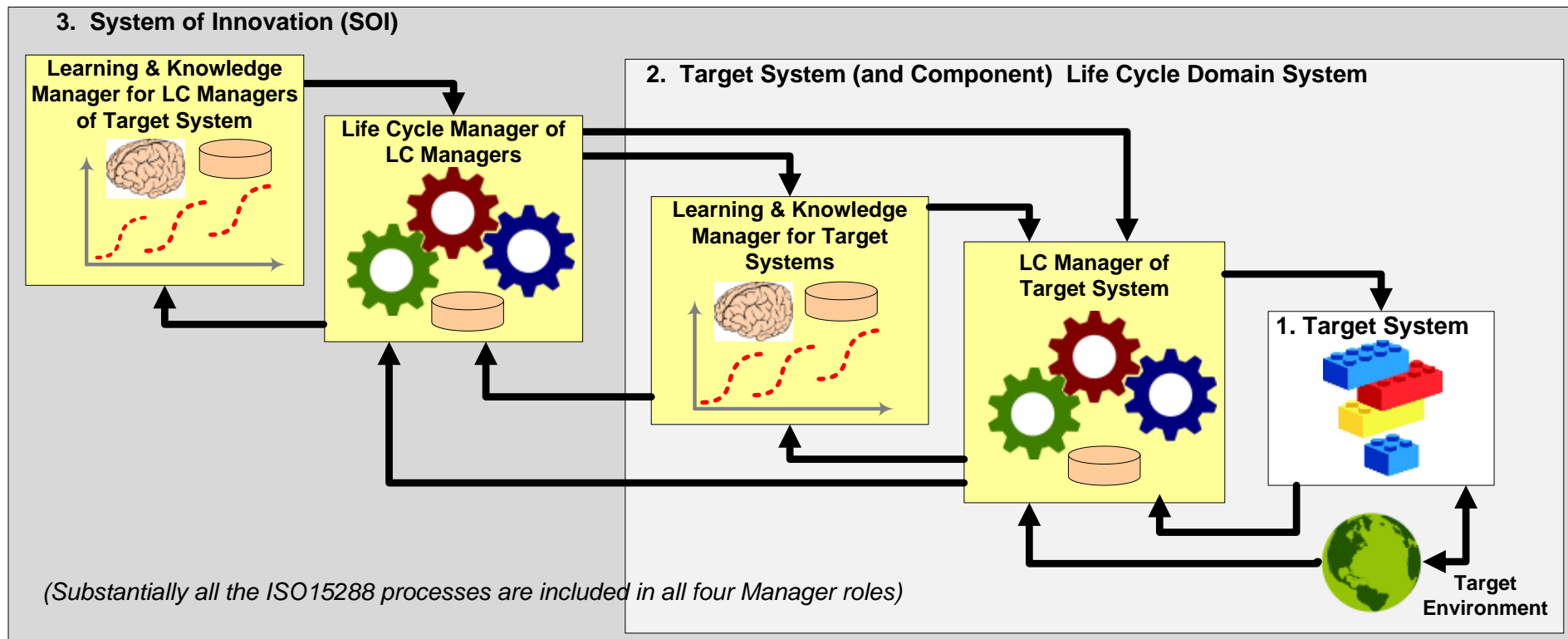

System 1: Target system of interest, to be engineered or improved.

System 2: The environment of (interacting with) S1, including all the life cycle management systems of S1, including learning about S1.

System 3: The life cycle management systems for S2, including learning about S2.

Most of the challenges discussed in INCOSE are System 2 and System 3 problems, not System 1 problems.

Where Do Systems Come From and Go?

System Life Cycle Trajectories in S*Space

- Configurations change over life cycles, during development and subsequently
- Trajectories (configuration paths) in S*Space
- Effective tracking of trajectories
- History of dynamical paths in science and math
- Differential path representation: compression, equations of motion

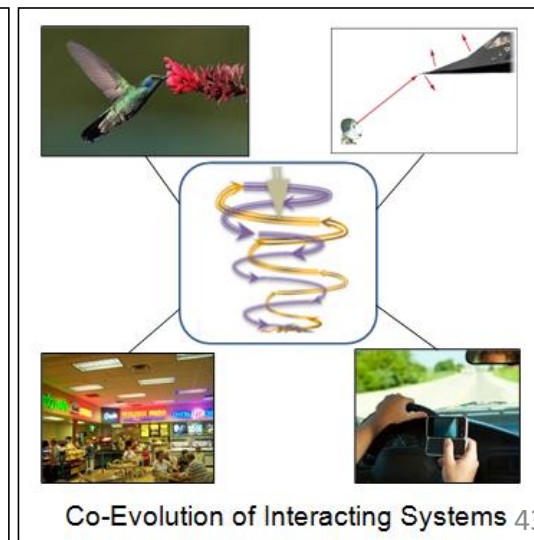
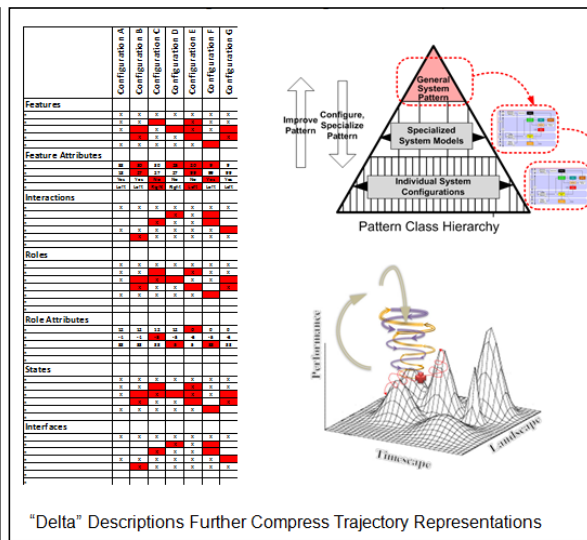
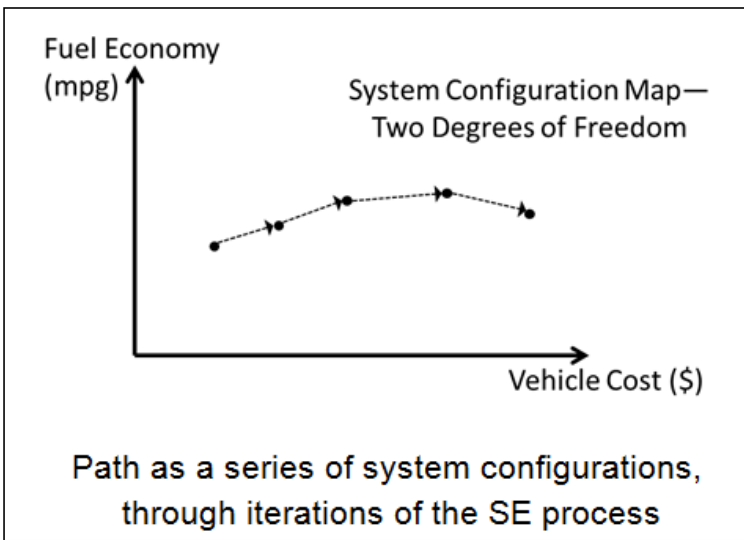

Maps vs. Itineraries -- SE Information vs. SE Process



Itinerary \neq Map!
(What am I doing?) (Where am I?)



When they eventually did emerge, maps represented a newer idea of the nature of "where".

- The SE Process consumes and produces information.
- But, SE historically emphasizes process over information. (Evidence: Ink & effort spent describing standard process versus standard information.)
- Ever happen?-- Junior staff completes all the process steps, all the boxes are checked, but outcome is not okay.
- Recent discoveries about ancient navigators: Maps vs. Itineraries.
- The geometrization of Algebra and Function spaces (Descartes, Hilbert)
- Knowing where you "really" are, not just what "step" you are doing.
- Knowing where you are "really" going, not just what "step" you are doing next.
- Distance metrics, inner products, projections in system configuration S^* Space.

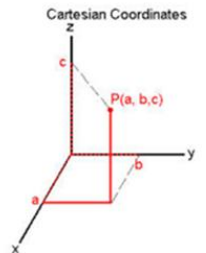

Rene Descartes
1596 - 1650

Geometrization of Algebra, by Rene Descartes

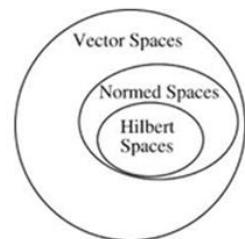

David Hilbert
1862 - 1943

Geometrization of Function Space, by David Hilbert

Maps vs. Itineraries -- SE Information vs. SE Process

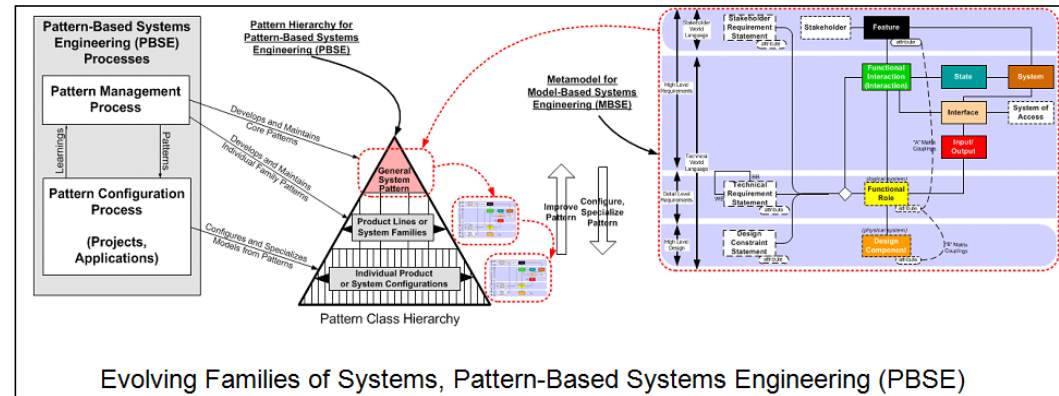
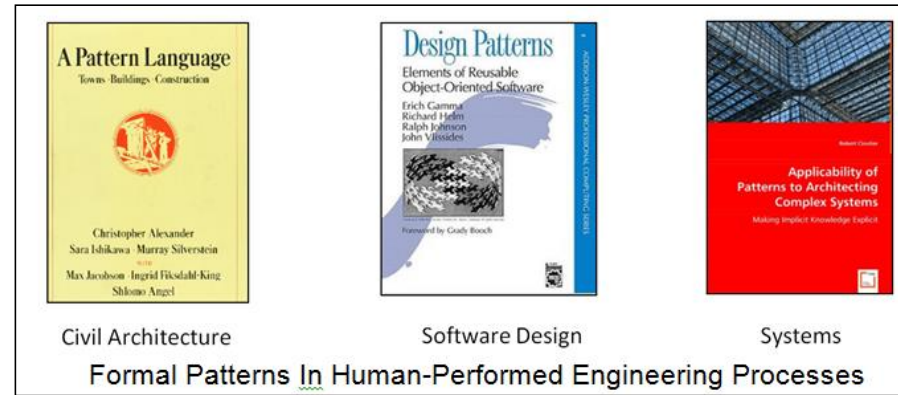
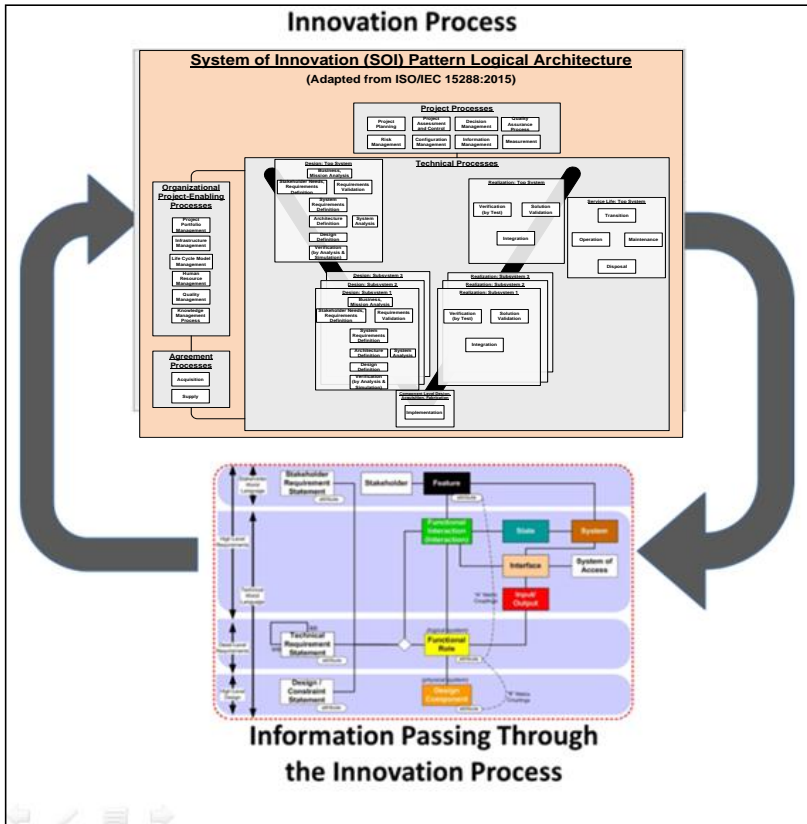

- Model-based Patterns in S*Space.
- Interactions as the basis of all laws of physical sciences.
- Relationships, not procedures, are the fruits of science used by engineers: Newton's laws, Maxwell's Equations.
- Immediate connection to Agility: knowing where you are--starting with better definition of what "where" means. There is a minimal "genome" (S*Metamodel) that provides a practical way to capture, record, and understand—the "smallest model of a system".
- Not giving up process: MBSE/PBSE version of ISO/IEC 15288.

Simple Geometric/Mathematical Idea: Subspace

Projections

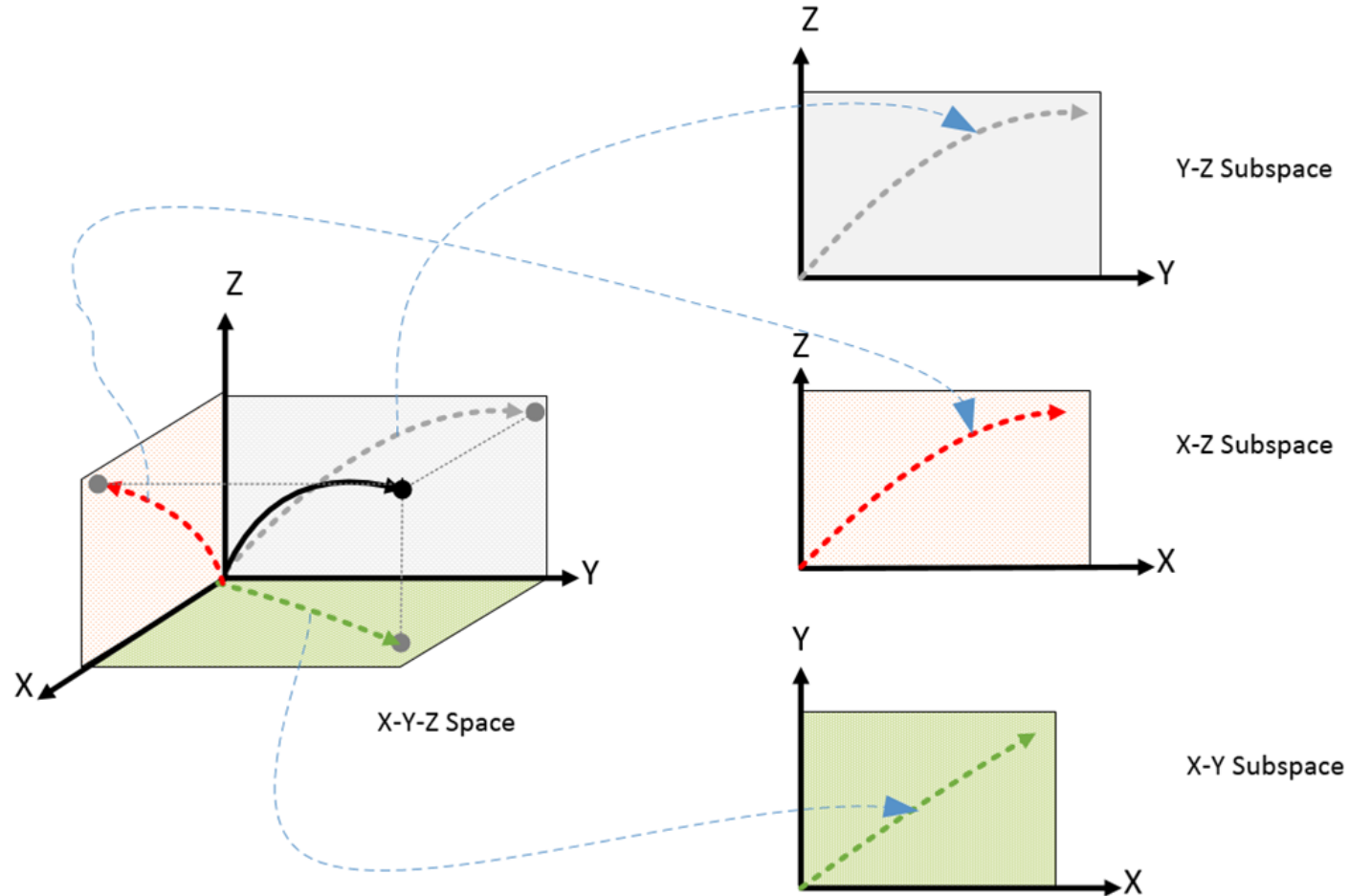

System Life Cycle Trajectories in S*Space, and S*Subspaces

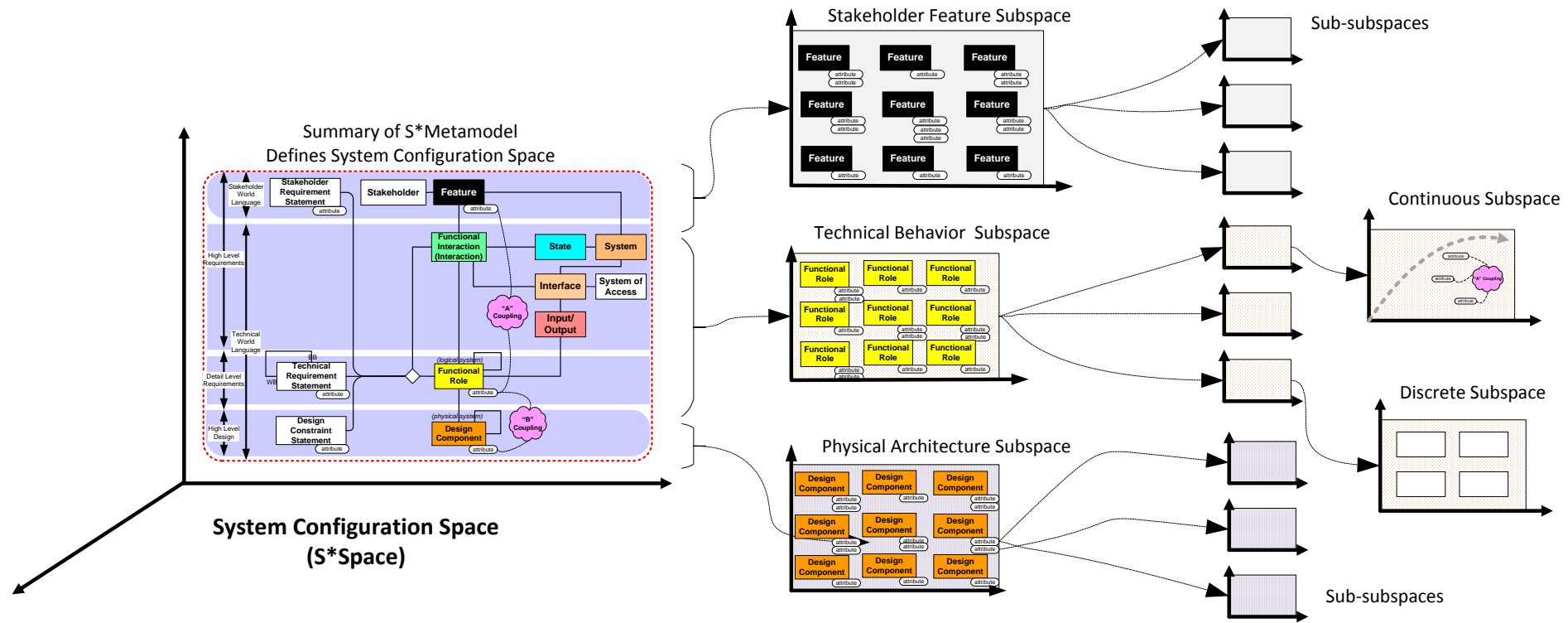

Agility as Optimal Trajectory Control in S*Space: Finding the Best Next Increment “Direction”

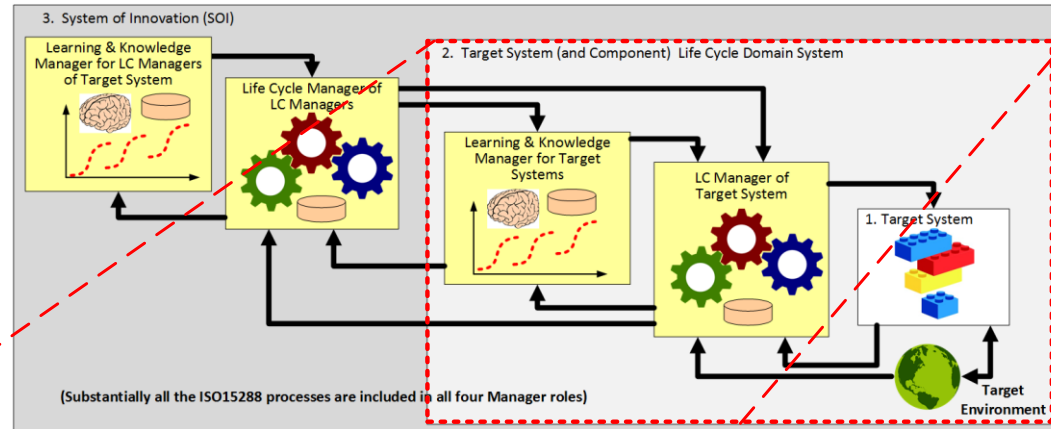

Stakeholder Feature Subspace

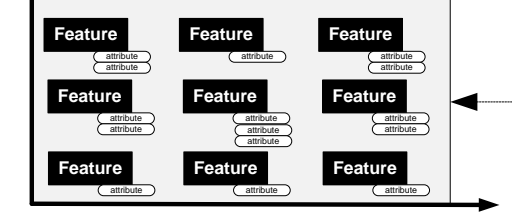

Technical Behavior Subspace

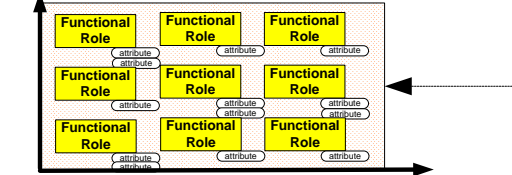

Physical Architecture Subspace

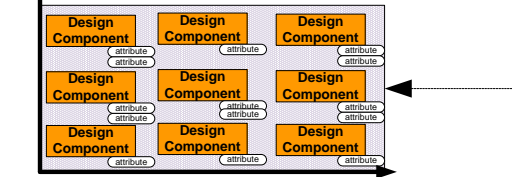

2. Target System (and Component) Life Cycle Domain System

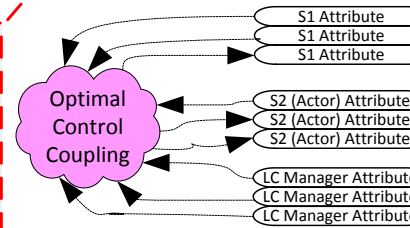
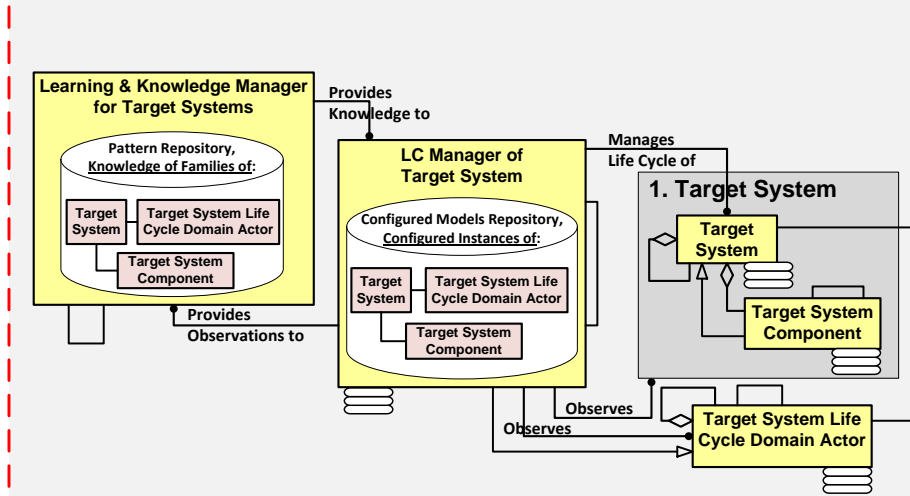

- Invisible Hand** →
- Visible Hand** →
- Clumsy Hand** →
- Optimal Hand** →
- Balanced Hand** →

System Configuration Subspace for Target System

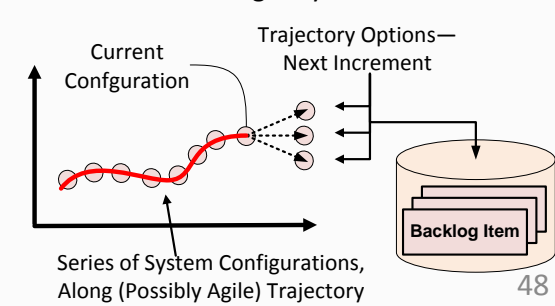

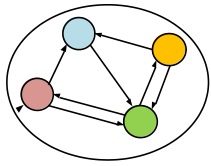

What You Can Do

- Practice expressing your systems' requirements and designs using models that explicitly represent their interactions:
 - The S*Metamodel provides a framework; see examples and references
- For the higher level systems challenging your efforts, look for opportunities to discover, express, and verify hard system patterns (repeatable parameterized models) of their higher level “phenomena”:
 - See the S*Patterns examples and references
- Help INCOSE make progress: Participate in the INCOSE Patterns Working Group on a related project on this subject:
<http://www.omgwiki.org/MBSE/doku.php?id=mbse:patterns:patterns>

1. INCOSE MBSE Initiative Patterns Working Group web site, at <http://www.omgwiki.org/MBSE/doku.php?id=mbse:patterns:patterns>
2. “Pattern-Based Systems Engineering (PBSE), Based On S*MBSE Models”, INCOSE PBSE Working Group, 2015: http://www.omgwiki.org/MBSE/doku.php?id=mbse:patterns:patterns_challenge_team_mtg_06.16.15
3. Pauling, L., *The Nature of the Chemical Bond and the Structure of Molecules and Crystals: An Introduction to Modern Structural Chemistry*, 3rd edition, Cornell University Press; 1960.
4. Cardwell, D.S.L. *From Watt to Clausius: The Rise of Thermodynamics in the Early Industrial Age*. London: Heinemann, 1971.
5. Sussman, G, Wisdom, J., *Structure and Interpretation of Classical Mechanics*, Cambridge, MA: MIT Press, 2001.
6. Levi, M., *Classical Mechanics with Calculus of Variations and Optimal Control*, American Mathematical Society, Providence, Rhode Island, 2014.
7. Kosmann-Schwarzbach, Y., *The Noether Theorems: Invariance and Conservation Laws in the Twentieth Century*, trans. by B. E. Schwarzbach, Springer, 2011.
8. Schindel, W., “What Is the Smallest Model of a System?”, *Proc. of the INCOSE 2011 International Symposium*, International Council on Systems Engineering (2011).
9. Schindel, W., “System Interactions: Making The Heart of Systems More Visible”, *Proc. of INCOSE Great Lakes Regional Conference*, 2013.
10. Schindel, W., “Got Phenomena? Science-Based Disciplines for Emerging System Challenges”, in *Proc. of INCOSE 2016 International Symposium*, International Council on Systems Engineering, 2016.
11. Schindel, W., “Where Do Systems Come From, and Where Do They Go?”, *Proc. of ISSS 2016*, Bolder, CO, 2016.
12. Schindel, W., “Innovation, Risk, Agility, and Learning, Viewed as Optimal Control & Estimation”, *Proc. of INCOSE 2017 International Symposium*, International Council on Systems Engineering, 2017.



2018
Annual **INCOSE**
international workshop
Jacksonville, FL, USA
January 20 - 23, 2018

www.incose.org/IW2018