

Future Directions for SysML v2 Update

INCOSE IW
January 20, 2018

Sanford Friedenthal
safriedenthal@gmail.com

Topics

- Introduction & Background
- SysML v2 Requirements Development Process
- SysML v2 Requirements Overview
- Summary

Introduction & Background



SysML Background

- SysML v1 adopted in 2006
- Continued evolution to address user and vendor needs
 - SysML v1.5: current version
 - SysML v1.6: in process
- Facilitated awareness and adoption of MBSE
- Much learned from applications of MBSE using SysML

Goal: Develop next generation of SysML to support MBSE over next 10+ years

Using SysML Model as an Integration Framework

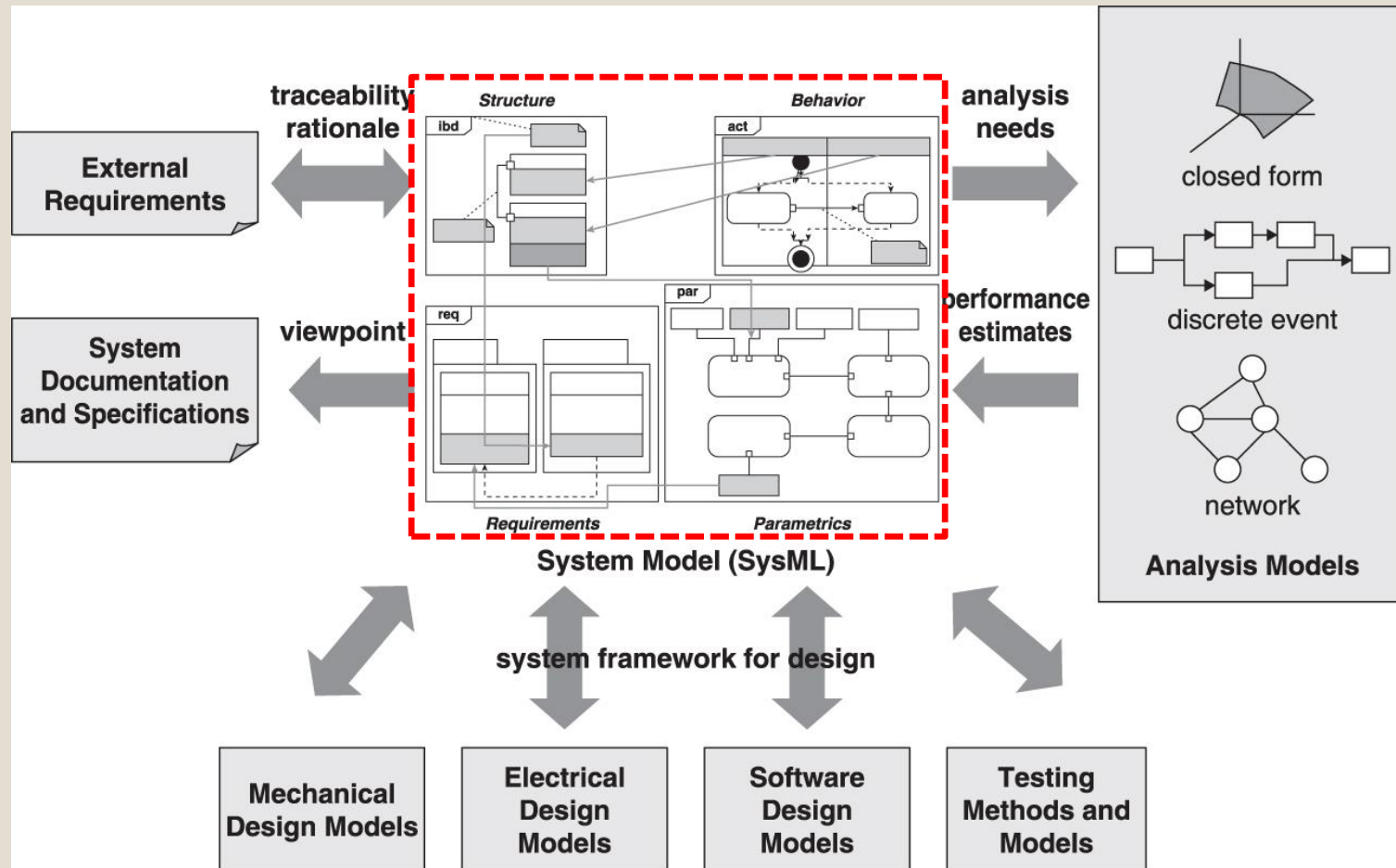

Source: A Practical Guide to SysML 3rd Ed: Figure 18.1

MBE To-Be State

Source: NDIA MBE Final Report dated February 2011

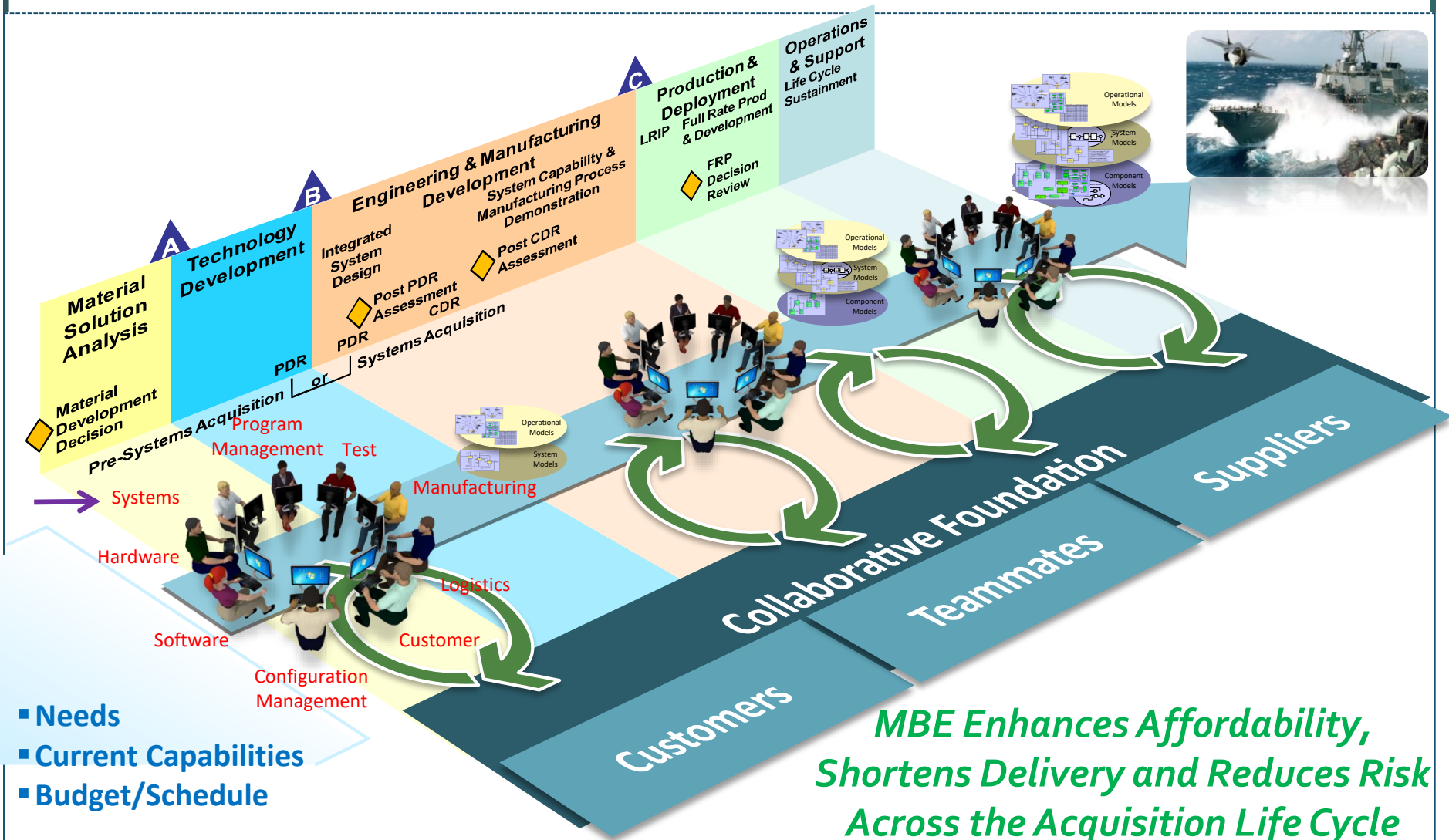

SysML v2 Requirements Development Process



SysML v2 Objectives

- Facilitate increased adoption and effectiveness of MBSE over SysML v1 through enhanced:
 - Precision & expressiveness
 - Consistency and integration among the language concepts
 - Interoperability with other engineering models and tools
 - Usability by model developers and consumers
- Refer to eleven (11) Statement of Needs From August 2015 INCOSE INSIGHT ‘Evolving SysML and the System Modeling Environment to Support MBSE’

SysML v2 Specification Development

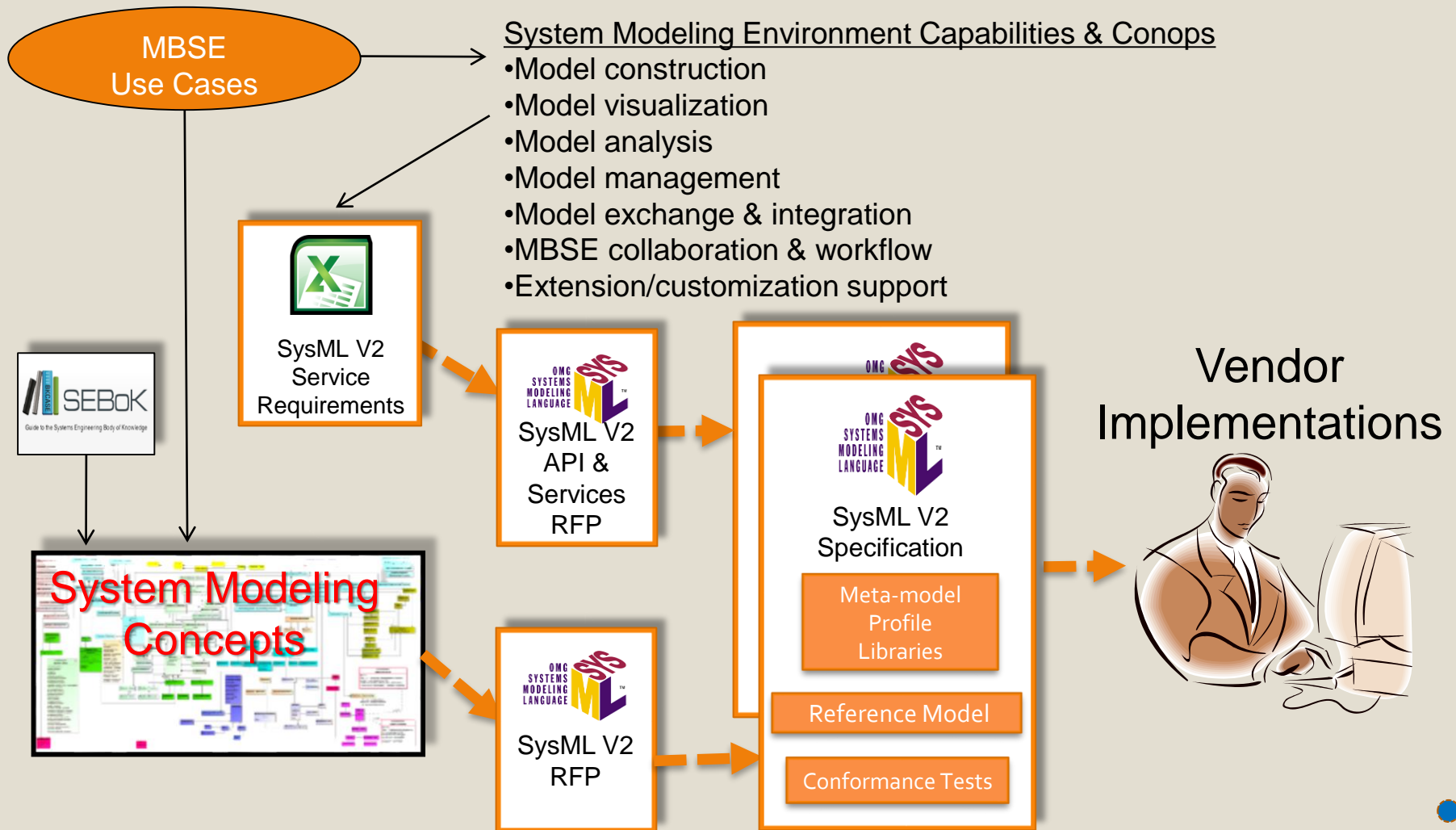

SysML v2 RFP

Contributors

Airbus – Yves Bernard

AIST – Geoffrey Biggs

ARAS – Pawel Chadzynski

BAE Systems – Steve Hetfield

Boeing – David Haines

Draper – Jeff Vodov

Hood Group - Bertil Muth

ESA/ESTEC - Hans Peter de Koning

John Deere – Roger Burkhart

KONEKSYS – Axel Reichwein

IBM – Eldad Palachi, Graham Bleakley

Intercax – Manas Bajaj

JPL – Marc Sarrel

Lockheed Martin – Chris Schreiber,

Chas Gayley, Andrew Mullis

Lightstreet Consulting – John Watson

LSST – Brian Selvy

MITRE – Laura Hart

ModelAlchemy – Uwe Kaufmann

NIST – Conrad Bock

nMeta – Ed Seidewitz

No Magic - Nerijus Jankevicius

OOSE – Tim Weilkiens

Phoenix Integration – Andy Ko

PTC – Hedley Apperly

Raytheon – Ron Williamson

SAF Consulting – Sanford Friedenthal

Simula Research Lab - Tao Yue, Shaukat Ali, Bran Selic

Skygazer Consulting - Rick Steiner

Tech Univ of KaisersLautern - Christian Muggeo

Thales – Stephane Bonnet

Tom Sawyer – Josh Feingold

Univ of Alabama in Huntsville – Jonathan Patrick

SysML v2

Development Milestones

Aug 2015	Driving Requirements (INCOSE MBSE Themed Insight Article)
June 2016	RFP Objectives, Scope, and Outline (Draft)
Dec 2016	SME Concept (INCOSE INSIGHT Article)
Jan 2017	Presentation at INCOSE IW
Mar 2017	Initial Draft Requirements (SECM, API, Formalism)
June 3 2017	SysML v2 Requirements Distributed for Working Group Review
July 3 2017	SysML v2 Requirements Distributed for Industry Review
Sept 2017	Draft SysML v2 RFP's and Presentation to ADTF
Dec 2017	OMG Vote to Issue SysML v2 RFP
June 2018	OMG Vote to Issue SysML v2 API and Services RFP
Dec 2017	Form SysML v2 Submission Teams
Dec 2019	Initial SysML v2 Submissions Due

SysML v2 Requirements Overview



SysML v2 Requirements

Top-level

- **A Modeling Language that is:**
 - a precisely defined vocabulary for modeling systems
 - specified as a SysML v2 profile and metamodel
 - based on industry standards for systems engineering
 - encompasses the scope of SysML v1.x
 - grounded in logical formalisms
- **An Application Program Interface (API) that:**
 - enables standard service requests to access and operate on SysML v2 models
 - facilitates interoperability between SysML modeling tools and other engineering modeling tools

Modeling Language



Language Specification: Providing a Uniform Interpretation

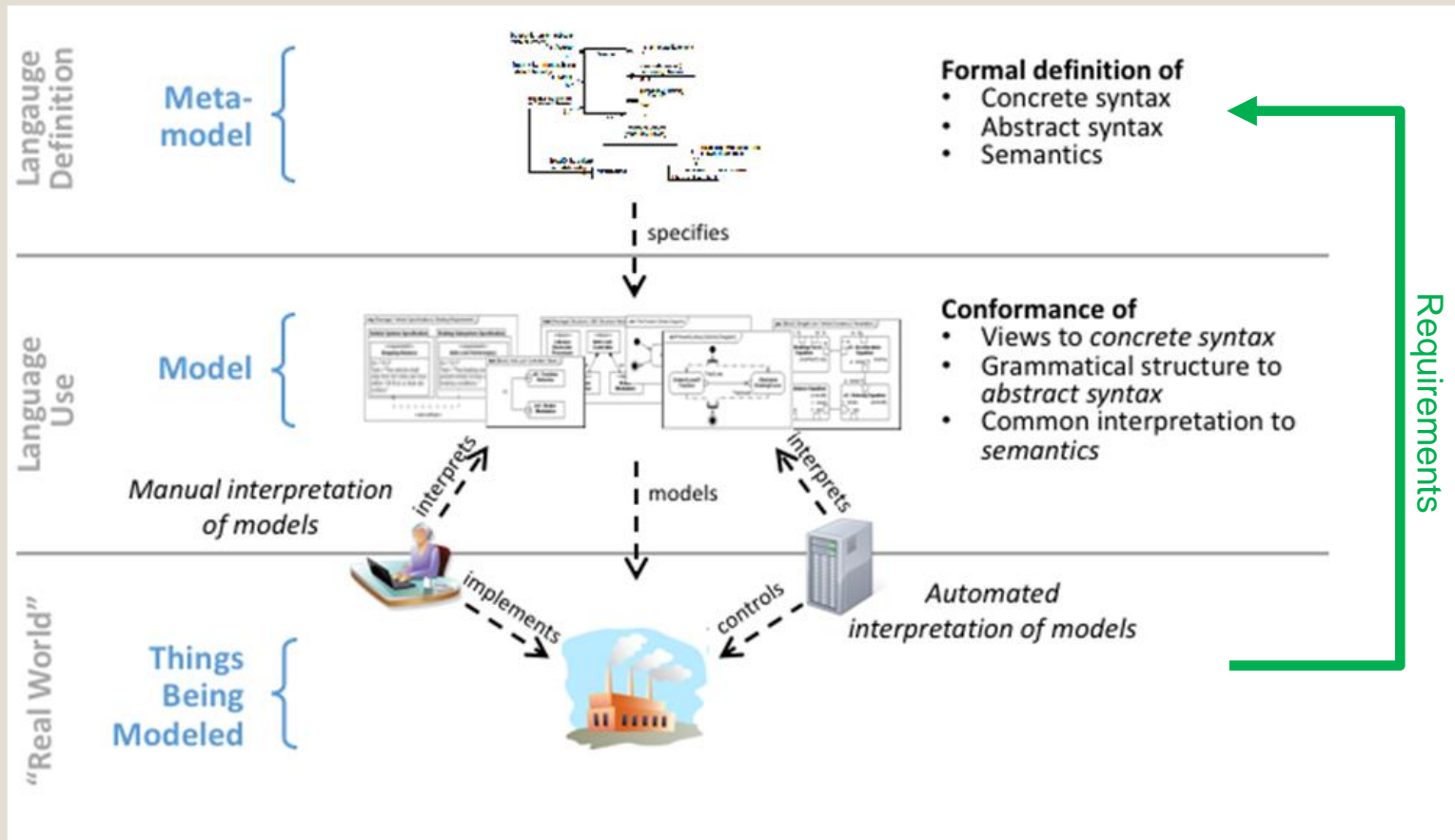

Source: Derived from SysML Formalism WG Presentation dated March 21, 2017

SysML v2 Metamodel and Profile

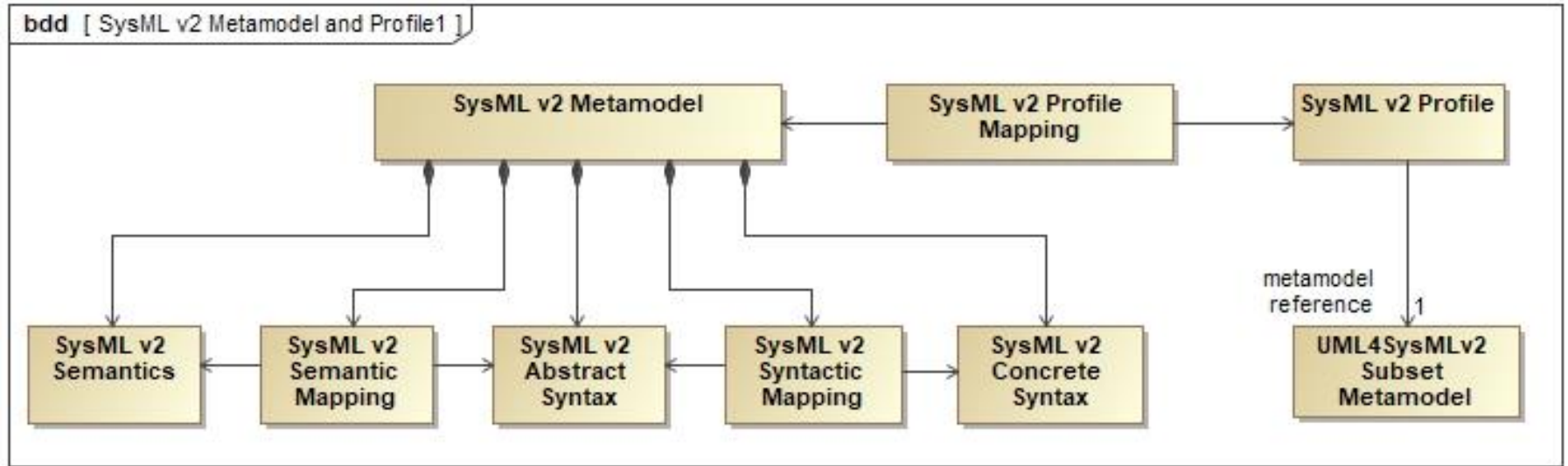

Core SEBoK Concepts

(Extract from draft SECM-2015 Industry Reference. Used with permission)

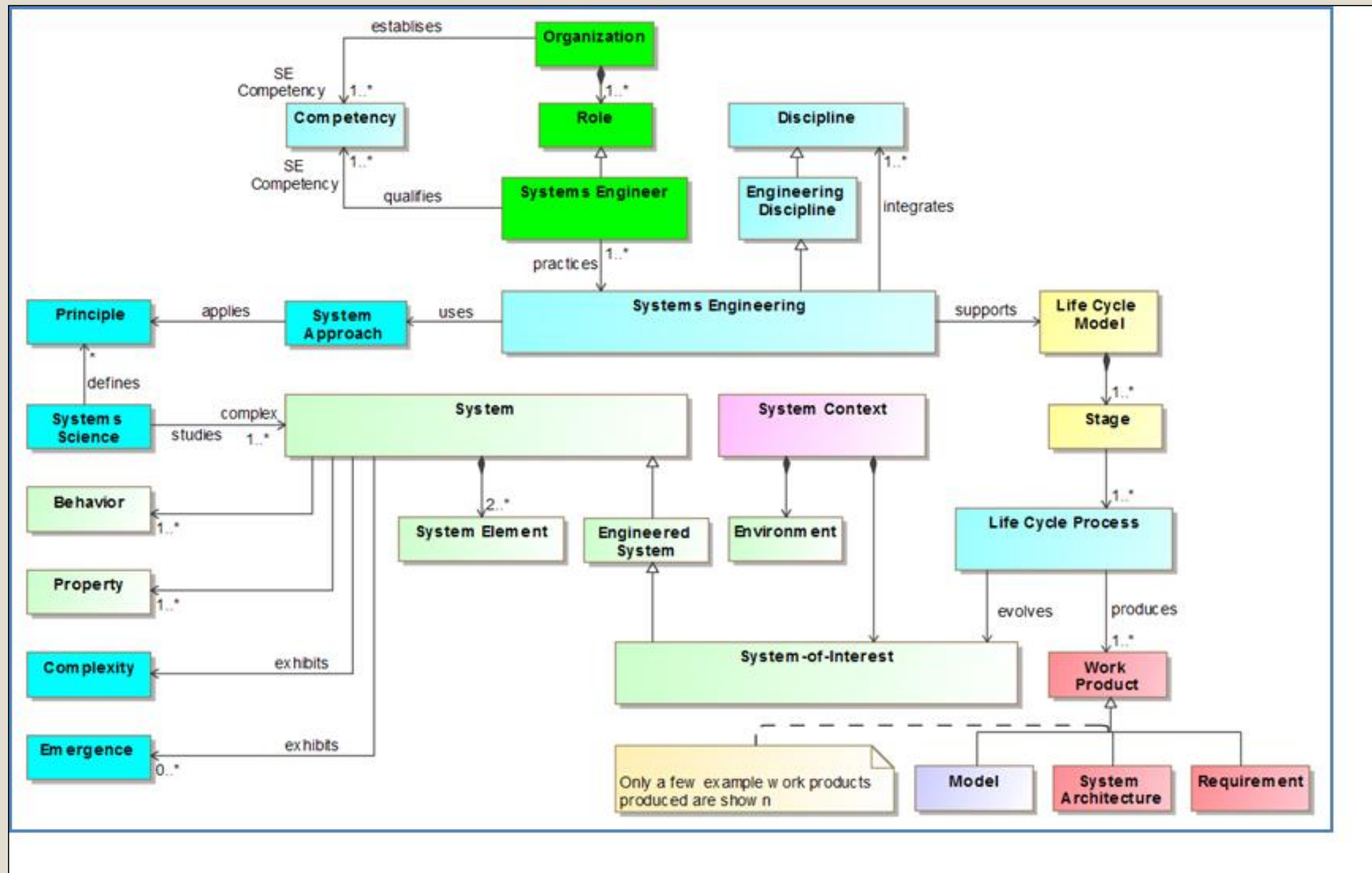

SysML v2 Modeling Concepts

The Pillars of SysML

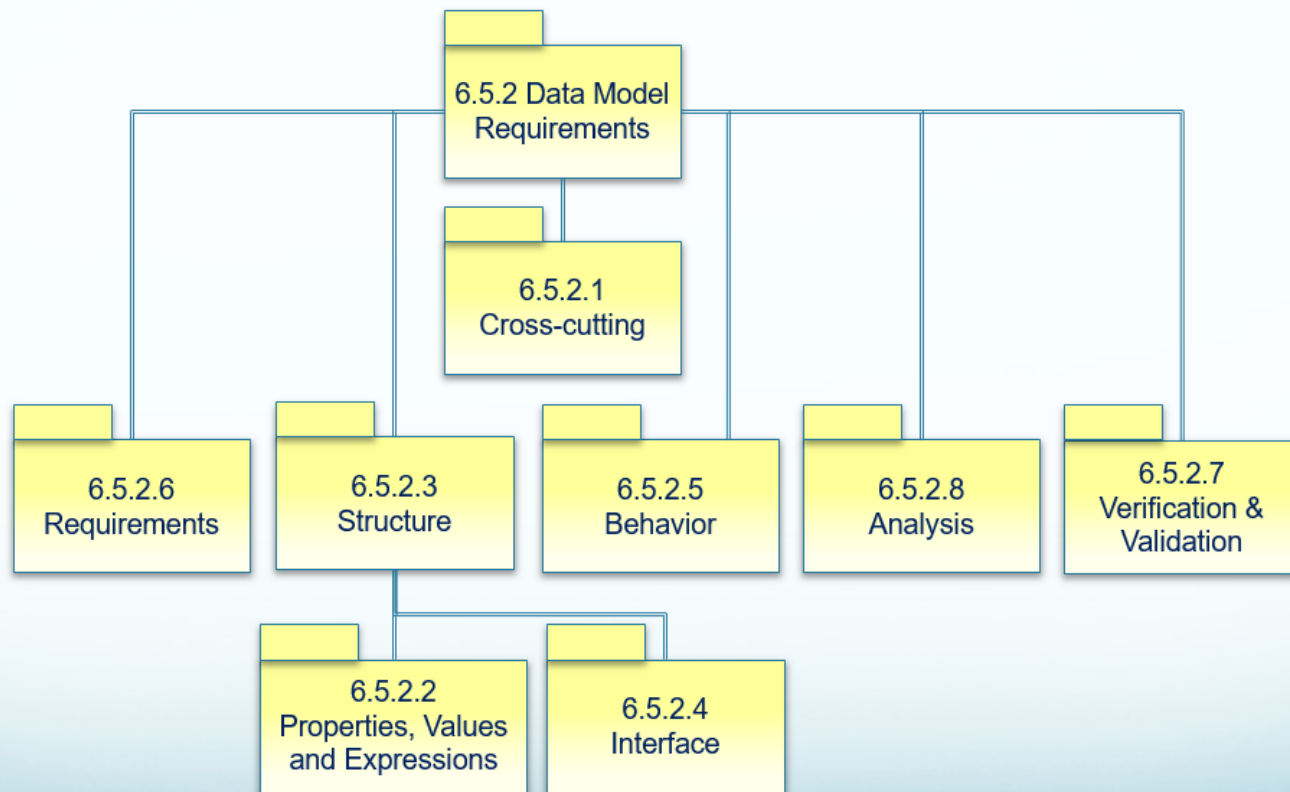

Integrated Views of a System

SysML v2 Enhancement Areas over SysML v1

Improved integration with Analysis

Geometric View

Trade Studies

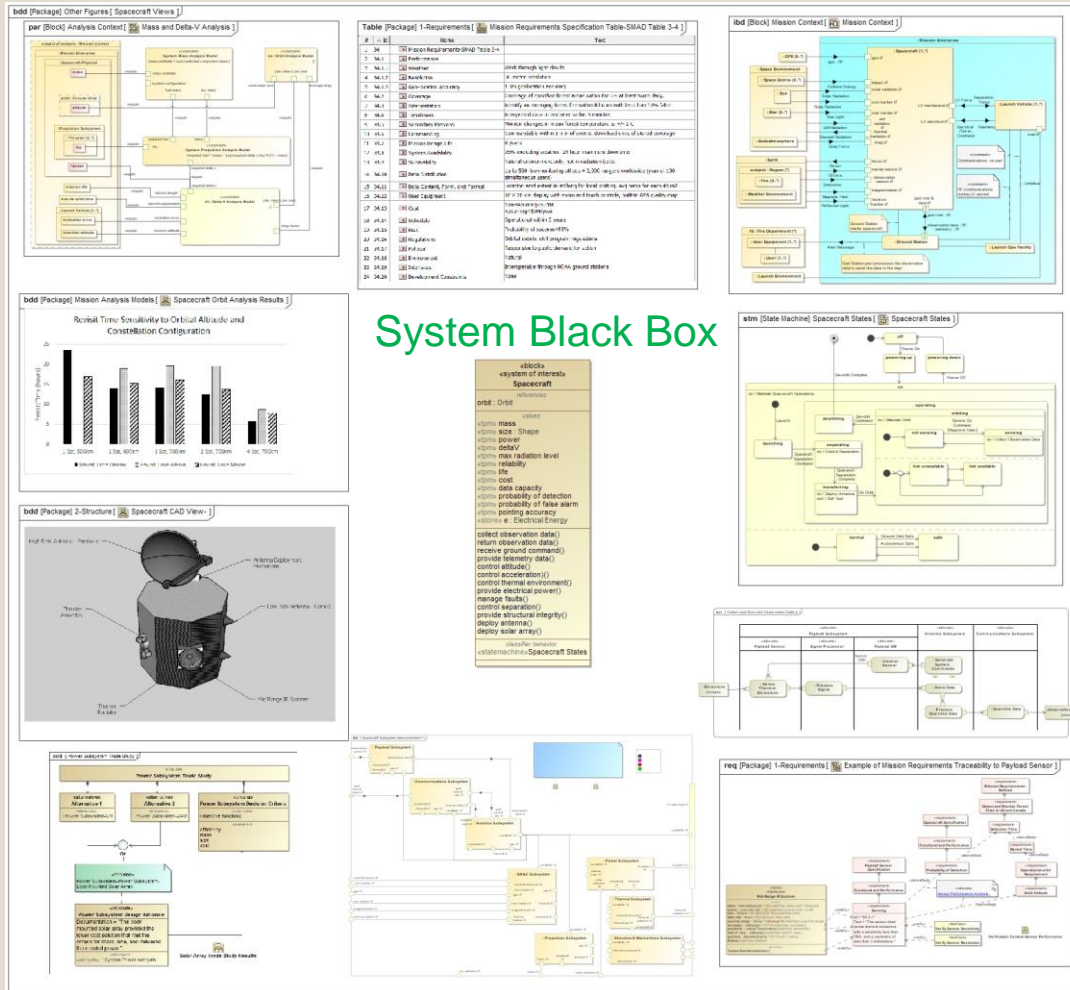

System Black Box

Variant Modeling & Design Configurations

Improved integration between Behavior & Structure

Property-based requirements

Source: Architecting Spacecraft with SysML

Copyright © 2012-2017 by Sanford Friedenthal, All Rights Reserved.

10/8/2017

SysML v2 Requirements Summary

Total	169 (+39 requirement groups)
- Language & Formalism req'ts	16 (+6 - conformance + 2 - ref model)
- Data Model req'ts	145
Number fully, partially, and not addressed by SysML v1	
- Fully addressed	40
- Partially addressed by	59
- Not addressed	70
	} 99
Mandatory	140
Non-mandatory	29

SysML v2 RFP (Draft)

Requirements in Section 6.5, 6.6

OMG Document #: ad-2017-12-02

6.5 Mandatory Requirements

6.5.1 Language Architecture

6.5.2 Data Model

6.5.2.1 Cross-cutting

6.5.2.2 Properties, Values, and Expressions

6.5.2.3 Structure

6.5.2.4 Interface

6.5.2.5 Behavior

6.5.2.6 Requirements

6.5.2.7 Verification

6.5.2.8 Analysis

6.5.3 Example Model

6.5.4 Conformance

6.6 Non-mandatory features

6.6.1 Language Architecture

6.6.2 Data Model

6.6.2.1 Cross-cutting

6.6.2.2 Properties, Values, and Expressions

6.6.2.3 Structure

6.6.2.4 Interface

6.6.2.5 Behavior

6.6.2.6 Requirements

6.6.2.7 Verification

6.6.2.8 Analysis

6.6.3 Model Libraries

Example Requirement

PRP 1.07: System of Units and Scales

SysML v2 shall include a capability to represent a named system of measurement units and scales to define the precise semantics of numerical Value Types in accordance with the [ISO/IEC 80000] standard.

Supporting Information: Similar to SysML v1 QUDV, SysML v2 should include model libraries representing the [ISO/IEC 80000] units, as well as the conversion to US Customary Units defined in [NIST SP 811] Appendix B.

SysML v1.X Constructs: SystemOfUnits in Annex E.5 QUDV

Conformance Tests

- The RFP will require submitters to provide
 - a conformance test suite with test cases traced to SysML v2 language feature requirements
 - a reference model demonstrating substantive use of SysML v2 features
- Submitters will be expected to provide a pilot implementation that satisfies all conformance tests and can manage the reference model

Application Program Interface



Approach

- Platform Independent Model + Platform Specific Bindings
 - Supports broad range of technologies and technology evolution
- Small number of mandatory services (e.g., query services)
- Additional non-mandatory services
 - Model Construction
 - Model Visualization
 - Model Analysis
 - Model Management
 - Workflow and Collaboration
 - Extension Services

Layered Architecture

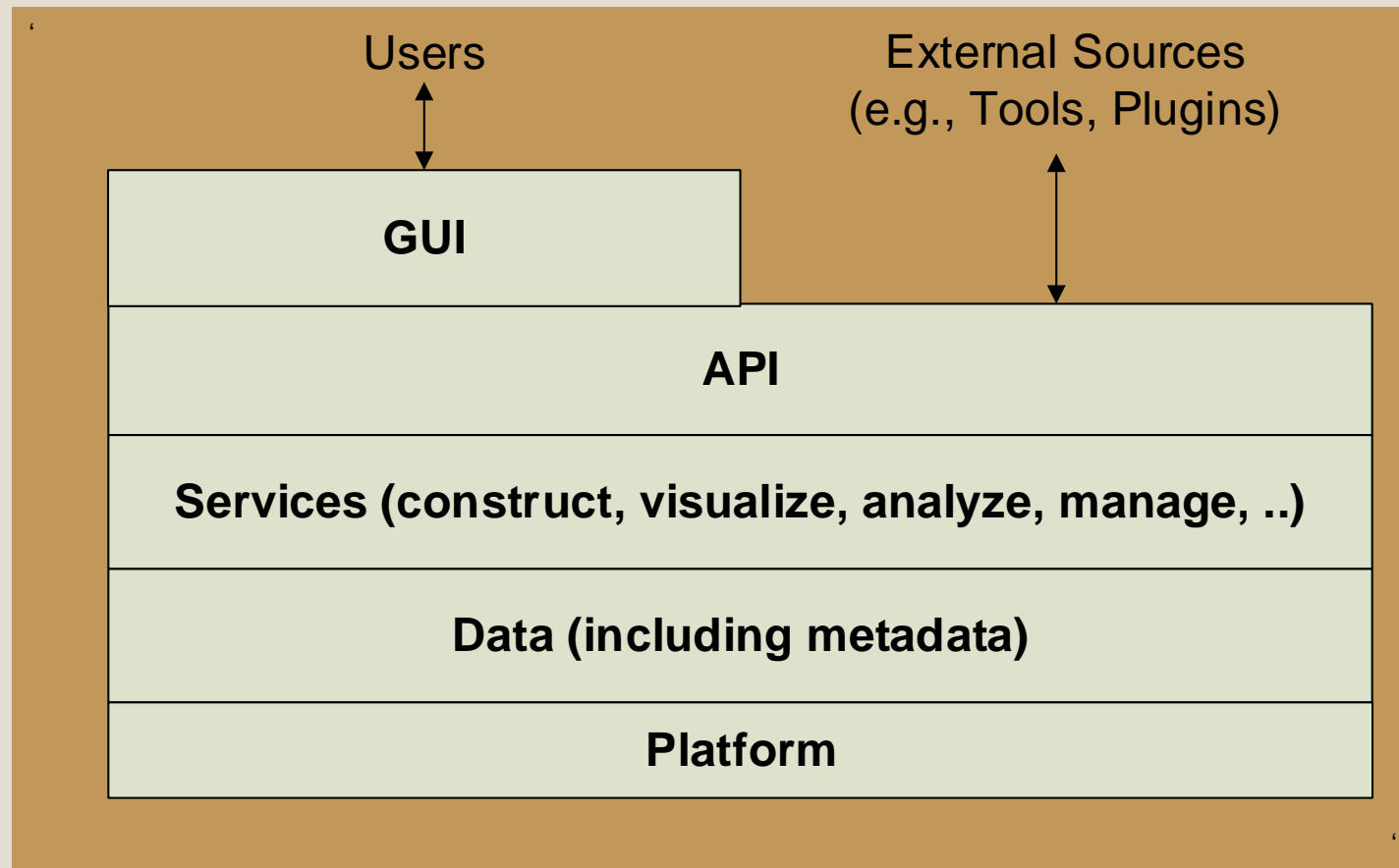

Standard API enables interoperability and access to modeling services

Summary



Summary

- SysML v1 available for 10 years
 - An enabler of MBSE
 - Strengths and limitations understood and basis for future improvements
- SysML v2 to improve support for MBSE adoption and use over next 10 years
 - Precision, expressiveness, and integration of concepts
 - Interoperability among engineering models and tools
 - Usability for diverse user base
- Status
 - SysML v2 RFP issued and Submission Teams established December 2017
 - SysML v2 API and Services RFP expected to be issued June 2018
 - Initial SysML v2 Submissions due December 2019

SysML v2 Requirements Documents

Dated 6 November 2017

RFP's

ad/2017-12-02 SysML v2 RFP - Final

ad/2017-12-05 SysML v2 API and Services RFP - Draft

Supporting Documents

syseng/2017-11-01 SysML v2 Requirements Support Document

OMG SysML v2 Requirements References

- Friedenthal, S, Burkhart, R. Evolving SysML and the System Modeling Environment to Support MBSE, INCOSE INSIGHT, Model-Based Systems Engineering, August 2015 (*August 15 Volume 18 Issue 2, Pg 39-42*)
 - Capabilities, effectiveness measures, and driving requirements for a **system modeling environment (SME)** to support MBSE
- Friedenthal, S. Evolving SysML and the System Modeling Environment to Support MBSE-Part 2, INCOSE INSIGHT, (*December 16 Volume 19 Issue 4, Pg 76-80*)
 - Concept for a **system modeling environment (SME)** to support MBSE
- OMG SysML v2 RFP Working Group Wiki
 - http://www.omgwiki.org/OMGSysML/doku.php?id=sysml-roadmap:sysml_assessment_and_roadmap_working_group

Questions ?

